

Surface Mount 905 nm Pulsed Semiconductor Lasers High Power Laser-Diode Family for Commercial Range Finding



Near field profile

Excelitas' pulsed semiconductor laser produces very high peak optical pulses centered at a wavelength of 905 nm. The package design can emit light parallel or perpendicular to the mounting plane.

Excelitas Technologies' pulsed semiconductor laser, emitting at 905nm in the near IR, uses a multi-layer monolithic chip design. The laser diode is mounted on an FR4 substrate leadless laminate carrier (LLC) with excellent thermal management. This is intended for both surface mount applications and hybrid integration. The encapsulate material is a molded epoxy resin for low cost and high-volume manufacturing.

The package design and assembly processing techniques are such that the die positioning is well controlled to the reference surfaces, as shown in Figure 5. This aids in the alignment of optical elements to the package and is superior to many of the commercially available plastic lead frame TO-18 and SMD style packages in the market. Quantum well laser design offers rise and fall times of <1 ns however the drive circuit layout and package inductance play a dominant role and should be designed accordingly.

Key Features

- Concentrated emitting source size for high power into aperture
- Multi-Epi Quantum well structure
- Excellent power stability with temperature
- RoHS compliant

Applications

- LIDAR
- Range finding
- Safety light curtains
- Adaptive cruise control
- Laser therapy

Surface Mount 905 nm Pulsed Semiconductor Lasers

High Power Laser-Diode Family for Commercial Range Finding

Table 1: Maximum Ratings

Parameter	Symbol	Minimum	Maximum	Units
Peak Reverse Voltage	V_{RM}		6	V
Pulse Duration	t_W		100	ns
Duty Factor	du		0.1	%
Storage Temperature	T_S	-40	105	°C
Operating Temperature	T_{OP}	-40	85	°C
Soldering for 5 Seconds			260	°C

Table 2: General Electro-optical Specifications at 23°C

Parameter	Symbol	Minimum	Typical	Maximum	Units
Centre Wavelength of Spectral Envelope	λ_c	895	905	915	nm
Spectral Bandwidth at 50% Intensity Points	$\Delta\lambda$		5		nm
Wavelength Temperature Coefficient	$\Delta T/\Delta\lambda$		0.25		nm/°C
Beam Spread (50% Intensity Points) Parallel to Junction Plane	$\theta_{ }$		10		degrees
Beam Spread (50% Intensity Points) Perpendicular to Junction Plane	θ_{\perp}		25		degrees

Table 3: Electro-optical Specifications at 23°C

Test Conditions: 50ns, 1 kHz

Characteristics	Symbol	TPGAD1S03H			TPGAD1S09H			Units
		Minimum	Typical	Maximum	Minimum	Typical	Maximum	
Emitting Area			76 X 10			229 X 10		μm
Optical Power Output	P_O	18	20		65	70		W
Drive Current	i_{FM}		10			30		A
Forward Voltage at i_{FM}^1	V_F		11			13.5		V
Threshold Current	i_{TH}		0.75			1.75		A
Series Resistance	R_S		0.454			0.23		Ω
Bandgap Voltage Drop	V_g		6.5			6.5		V

Note 1: As estimated by $V_F = R_S i_F + V_g$.

Surface Mount 905 nm Pulsed Semiconductor Lasers

High Power Laser-Diode Family for Commercial Range Finding

Electro-Optical Characteristics

Figure 1:

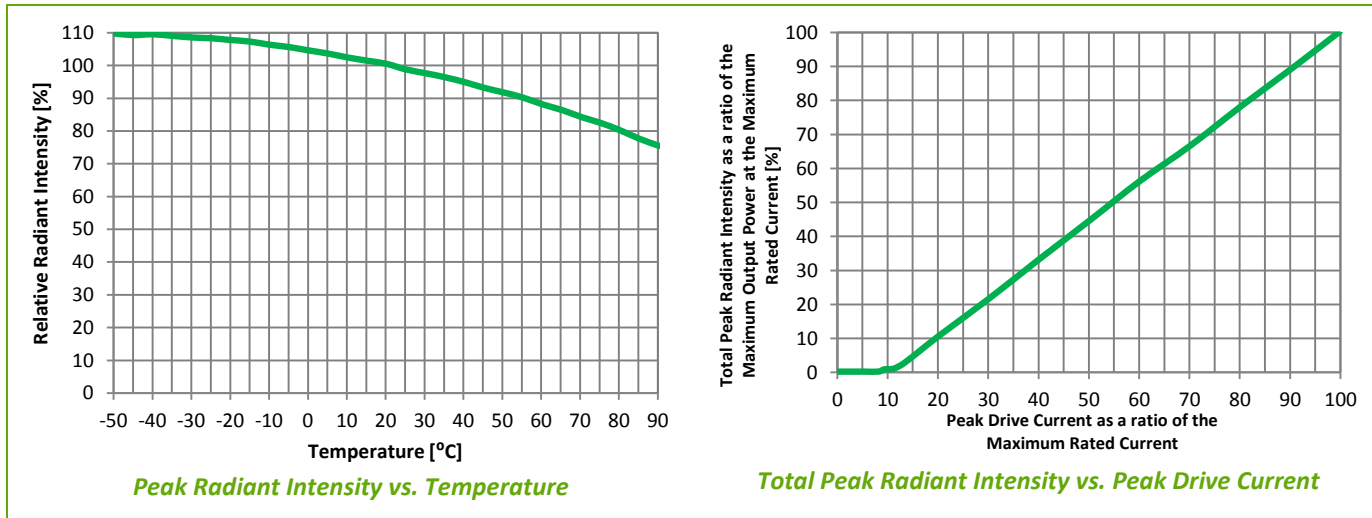

Figure 2:

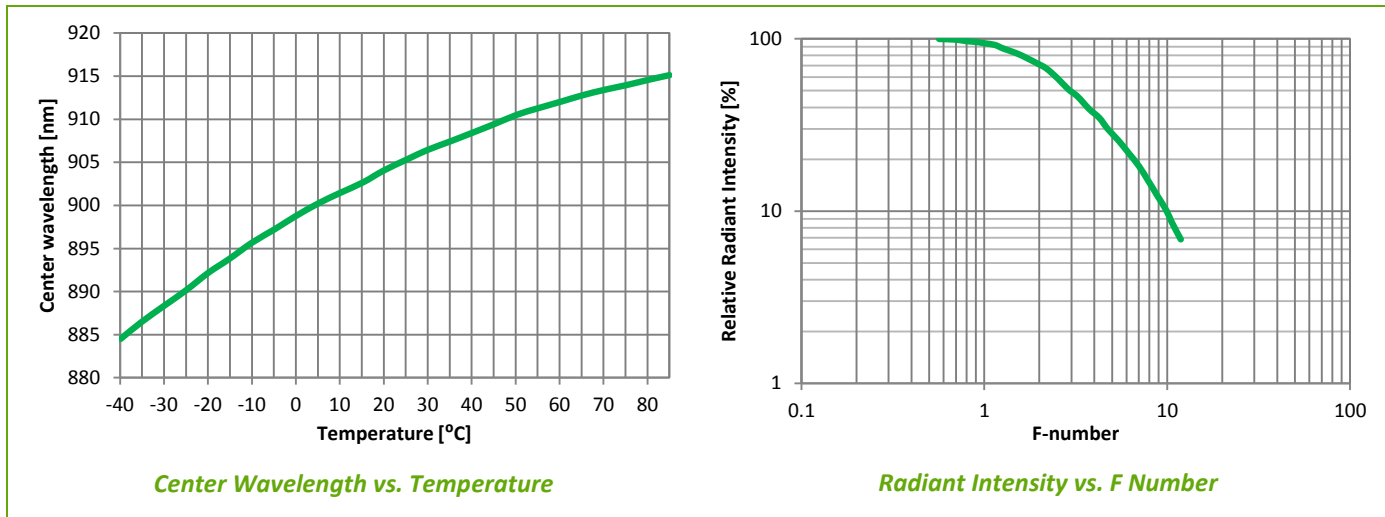
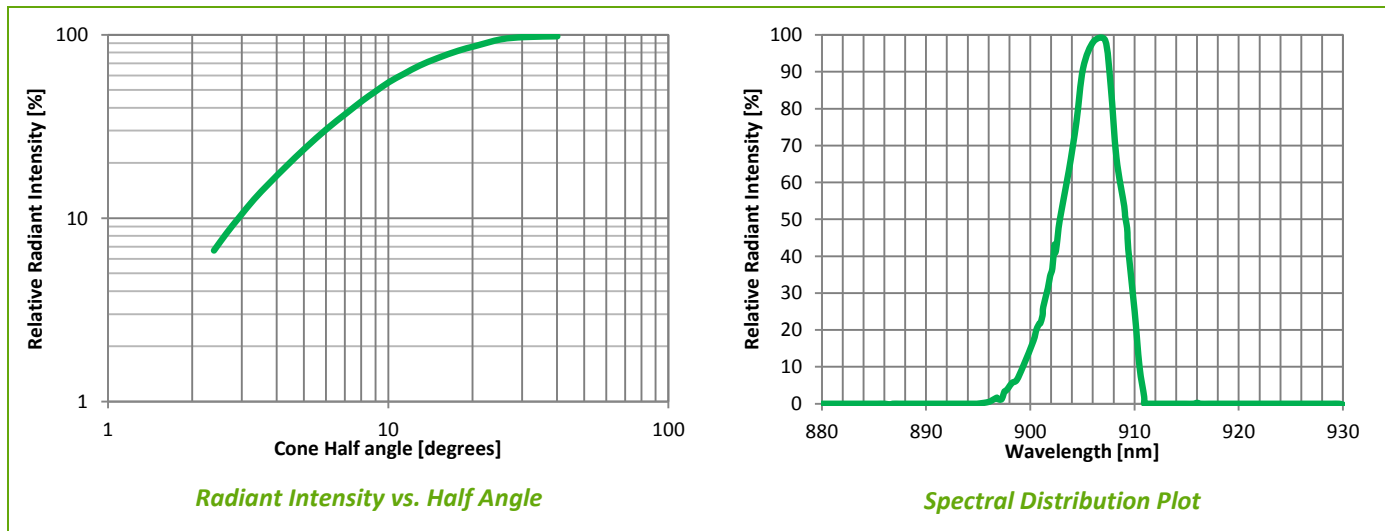

Figure 3:



Surface Mount 905 nm Pulsed Semiconductor Lasers

High Power Laser-Diode Family for Commercial Range Finding

Figure 4:

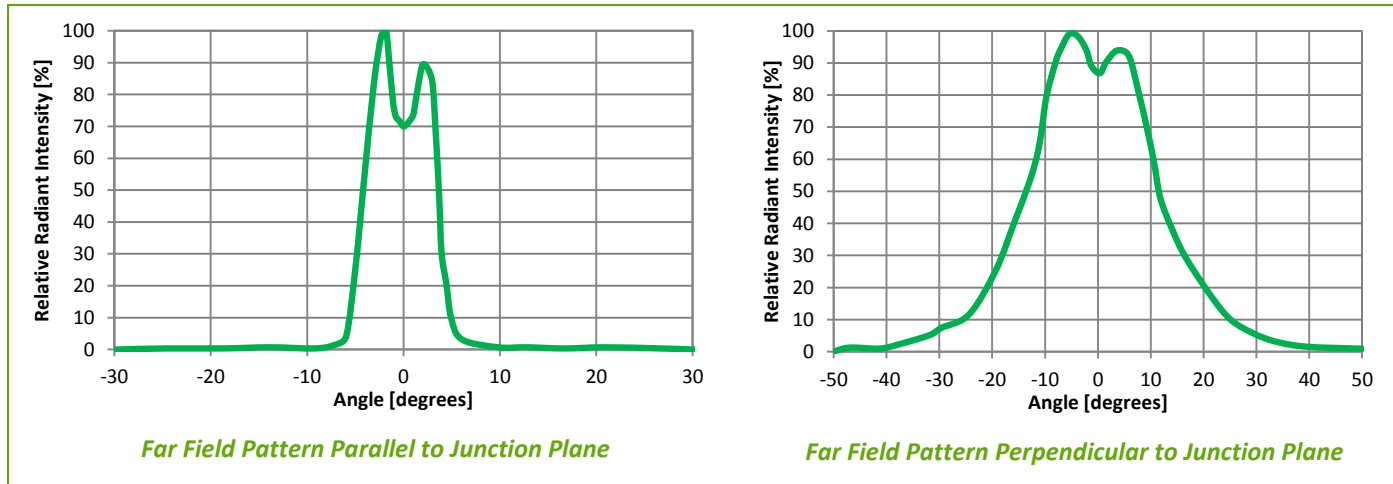
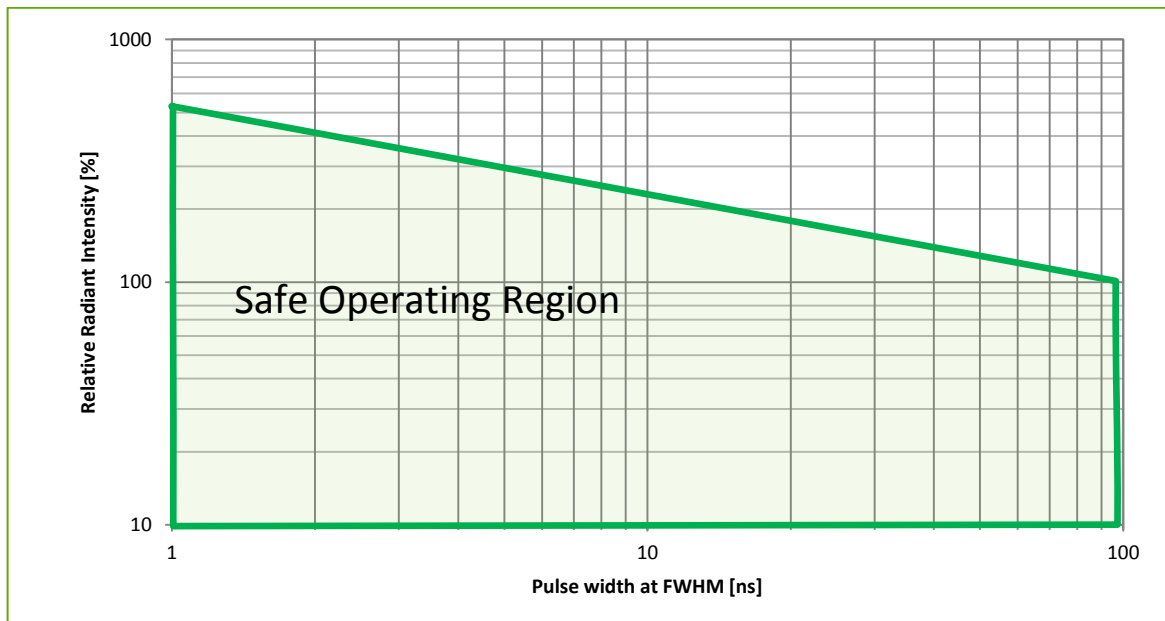

Figure 5: Radiant Intensity vs. Pulse Width for Safe Operation



Surface Mount 905 nm Pulsed Semiconductor Lasers

High Power Laser-Diode Family for Commercial Range Finding

Figure 5: Package Mechanical Dimensions

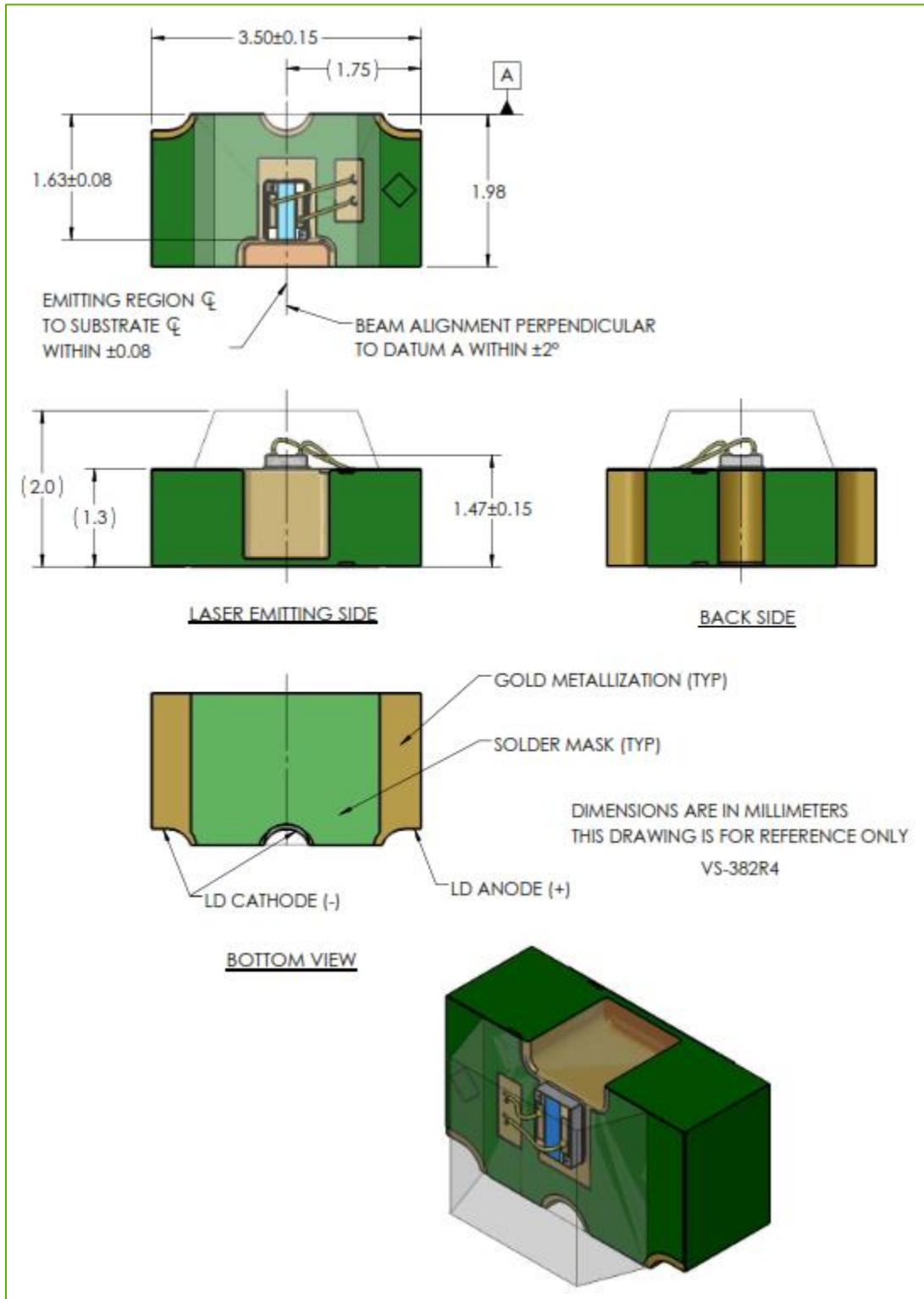

Surface Mount 905 nm Pulsed Semiconductor Lasers

High Power Laser-Diode Family for Commercial Range Finding

Thermal Simulation

Figure 6: Thermal resistance of Chip Junction to Main Board θ_{JB} .

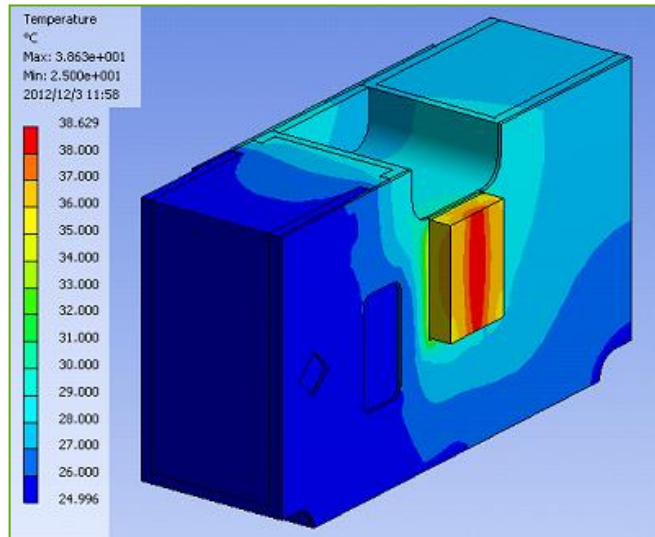

Thermal resistance $\theta_{JB} = 68^{\circ}\text{C}/\text{W}$.

Substrate attach to main board: solder.
Main board temperature controlled at 25°C.

PCB Mounting

Figure 7: Proposed Soldering Pad Pattern & Dimensions, Top and Side Looking Orientation on Main Board

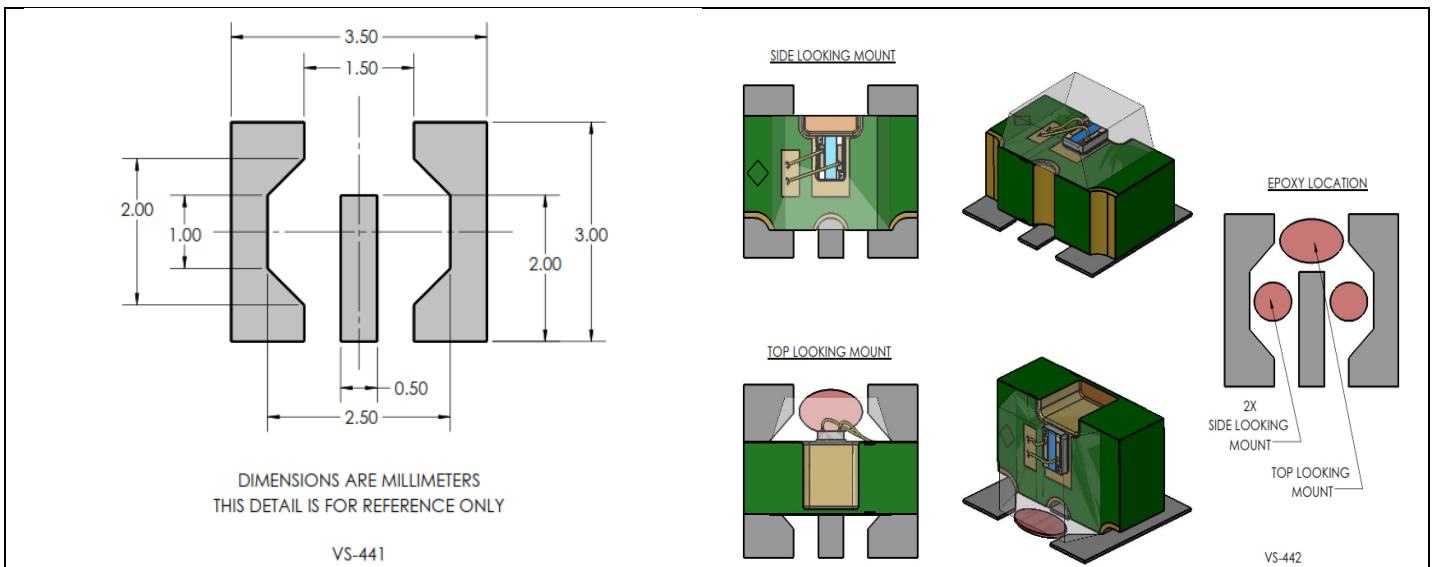

Disclaimer: The above solder pattern is a recommendation compatible with top- and side-looking laser mounting. The use of a small quantity of epoxy meant to cure rapidly, such as Epo-tek 353ND, snap-cured at the start of the solder reflow can help maintain proper alignment and aid in preventing tombstoning.

In the re-flow process design, special considerations should be taken into account to customize the process, such as other components included, oven efficiency, overall board size and mass, and printed-circuit board density.

The process can also be affected by the method of deposition and type of solder paste selected. Therefore the provided pattern and profile should be considered a process development starting point.

The processing of dummy boards with thermal-sensors attached is highly recommended to fine-tune and optimize the process to meet your assembly needs.

Surface Mount 905 nm Pulsed Semiconductor Lasers

High Power Laser-Diode Family for Commercial Range Finding

Figure 8: Recommended typical solder reflow profile (specific reflow soldering parameters depend on solder alloy used).

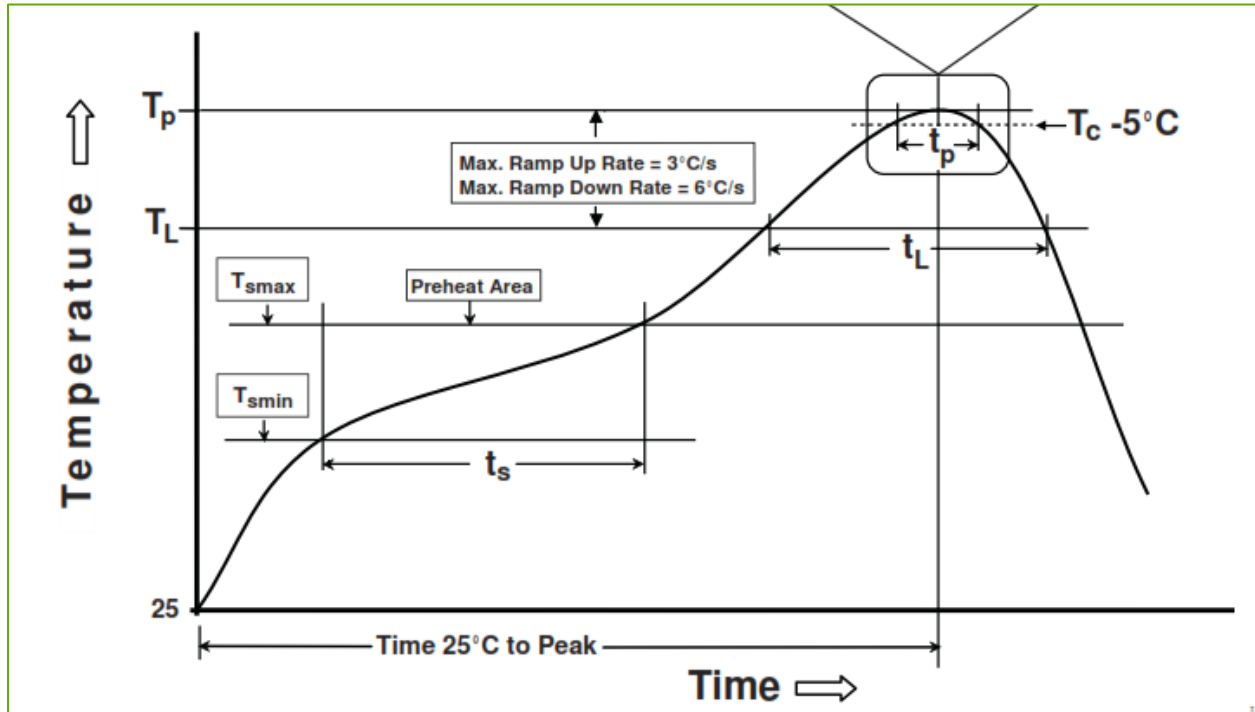

Profile Feature	Symbol	Value	Units
Pre-Heat			
Temperature min	T_{smin}	150	°C
Temperature max	T_{smax}	200	°C
Time (T_{smin} to T_{smax})	t_s	75	seconds
Temperature maintained above	T_L	217	°C
Time maintained above	t_L	65	seconds
Peak Temperature	T_p	244	°C
Time within 5°C of the actual peak temperature (T_p)		25	seconds
Ramp down rate		2	°C/second
Time 25°C to Peak Temperature		4	Minutes

Surface Mount 905 nm Pulsed Semiconductor Lasers

High Power Laser-Diode Family for Commercial Range Finding

Figure 9: Tape and Reel Packaging Dimensions

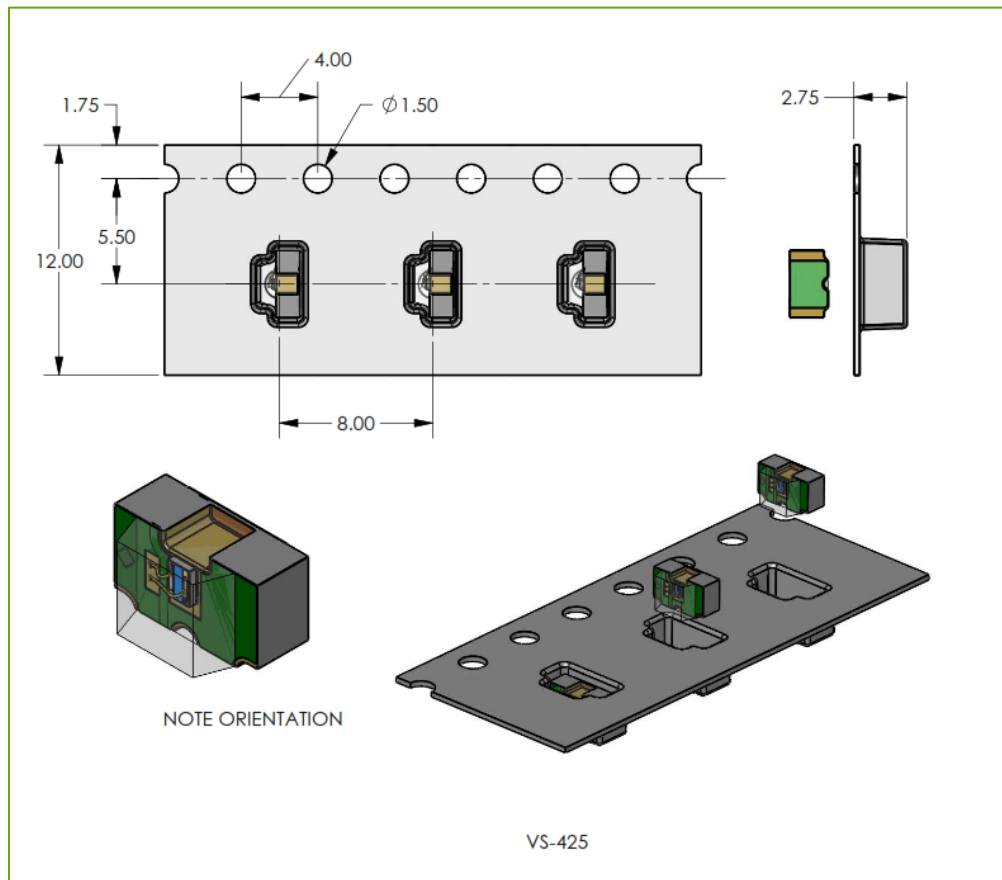

MLS Rating

This series of laser diodes comply with a Moisture Sensitivity Level (MSL) rating of 3 as defined in IPC/JEDEC- J-STD-033C. This allows for up to 168 hour floor life at $\leq 30^{\circ}\text{C}$ / 60%RH once removed from the sealed reel packaging. For complete details refer to the IPC/JEDEC- J-STD-033C specification.

For Your Safety: Laser Radiation

Under operation, these devices produce invisible electromagnetic radiation that may be harmful to the human eye. To ensure that these laser components meet the requirements of Class IIIb laser products, they must not be operated outside their maximum ratings. Power supplies used with these components must be such that the maximum peak forward current cannot be exceeded. It is the responsibility of the user incorporating a laser into a system to certify the Class of use and ensure that it meets the requirements of the ANSI or appropriate authority.

Further details may be obtained in the following publications:

21CFR 1040.10 – “Performance Standards for Light Emitting Products (Laser Products)”

ANSI Z136.1 – “American National Standard for Safe use of Lasers”

IEC 60825-1 – “Safety of Laser Products”

Surface Mount 905 nm Pulsed Semiconductor Lasers

High Power Laser-Diode Family for Commercial Range Finding

RoHS Compliance

This series of laser diodes are designed and built to be fully compliant with the European Union Directive 2011/65/EU – Restriction of the use of certain Hazardous Substances in Electrical and Electronic equipment.



Warranty

A standard 12-month warranty following shipment applies.

About Excelitas Technologies

Excelitas Technologies is a global technology leader focused on delivering innovative, customized solutions to meet the lighting, detection and other high-performance technology needs of OEM customers.

Excelitas has a long and rich history of serving our OEM customer base with optoelectronic sensors and modules for more than 45 years beginning with PerkinElmer, EG&G, and RCA. The constant throughout has been our innovation and commitment to delivering the highest quality solutions to our customers worldwide.

From aerospace and defense to analytical instrumentation, clinical diagnostics, medical, industrial, and safety and security applications, Excelitas Technologies is committed to enabling our customers' success in their specialty end-markets. Excelitas Technologies has approximately 5,000 employees in North America, Europe and Asia, serving customers across the world.

Excelitas Technologies
22001 Dumberry Road
Vaudreuil-Dorion, Quebec
Canada J7V 8P7
Telephone: (+1) 450.424.3300
Toll-free: (+1) 800.775.6786
Fax: (+1) 450.424.3345
detection.na@excelitas.com

**Excelitas Technologies
GmbH & Co. KG**
Wenzel-Jaksch-Str. 31
D-65199 Wiesbaden
Germany
Telephone: (+49) 611 492 430
Fax: (+49) 611 492 165
detection.europe@excelitas.com

Excelitas Technologies Singapore, Pte. Ltd.
8 Tractor Road
Singapore 627969
Telephone: (+65) 6775 2022 (Main number)
Telephone: (+65) 6770 4366 (Customer Service)
Fax: (+65) 6778-1752
detection.asia@excelitas.com



For a complete listing of our global offices, visit www.excelitas.com/locations

© 2014 Excelitas Technologies Corp. All rights reserved. The Excelitas logo and design are registered trademarks of Excelitas Technologies Corp. All other trademarks not owned by Excelitas Technologies or its subsidiaries that are depicted herein are the property of their respective owners. Excelitas reserves the right to change this document at any time without notice and disclaims liability for editorial, pictorial or typographical errors.