

Chip tantalum capacitors with open-function built-in

TCFG series P Case

●Features

- 1) Safety design by open function built - in.
- 2) Wide capacitance range
- 3) Screening by thermal shock.

●External dimensions (Unit : mm)

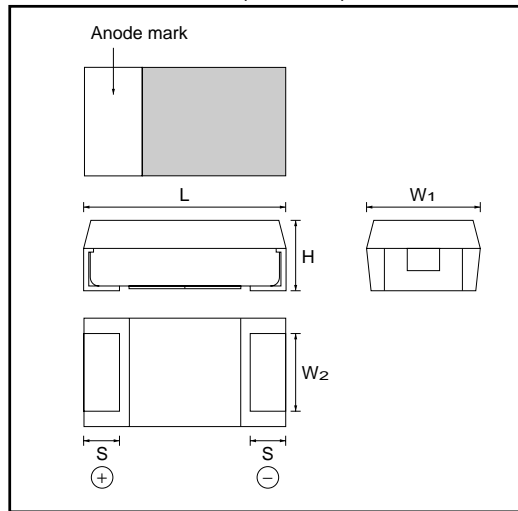

Case code	L	W ₁	W ₂	H	S
P (2012)	2.0±0.2	1.25±0.2	0.9±0.2	Max.1.20	0.45±0.3

●Product designation

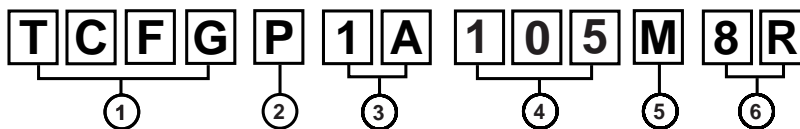

① Series name
TCFG

② Case code
TCFG P

③ Rated Voltage

Rated voltage (V)	4	6.3	10	16	20	25
CODE	0G	0J	1A	1C	1D	1E

④ Capacitance
Nominal capacitance in pF in 3 digits : 2significant figure representing the number of 0's.

⑤ Capacitance tolerance
M : ±20% K : ±10%

⑥ Taping
8 : Tape width (8mm)
R : Positive electrode on the side opposite to sprocket hole

Tantalum capacitors

●Capacitance range

TCFG series P Case

(μF)	Rated voltage					
	4 0G	6.3 0J	10 1A	16 1C	20 1D	25 1E
1.0 (105)			P	P	P	P
1.5 (155)		P	P	P		
2.2 (225)	P	P	P	P		
3.3 (335)	P	P	P	P		
4.7 (475)	P	P	P			
6.8 (685)	P	P				
10 (106)	P	P				
15 (156)	P	P				
22 (226)	P					
33 (336)						
47 (476)						
68 (686)						

Remark) Case size codes (P) in the above show each size products line-up.

●Marking

The indications listed below should be given on the surface of a capacitor.

- ① Polarity : The polarity should be shown by □ bar. (on the anode side)
- ② Rated DC voltage : Due to the small size of P case, a voltage code is used as shown below.
- ③ Nominal capacitance

Voltage Code	Rated DC Voltage (V)
g	4
j	6.3
A	10
C	16
D	20
E	25

Capacitance Code	Nominal Capacitance (μF)
A	1.0
E	1.5
J	2.2
N	3.3
S	4.7
W	6.8
a	10
e	15
j	22

Visual typical example (1) voltage code (2) capacitance code

[P Case] note 1) $\begin{matrix} j & J \\ \overline{(1)} & \overline{(2)} \end{matrix}$



note 2) voltage code and capacitance code are variable with parts number

Tantalum capacitors

●Characteristics

Item		Performance	Test conditions (based on JIS C5101-1 and JIS C5101-3)															
Operating Temperature		-55 °C to +125 °C	Voltage reduction when temperature exceeds +85°C															
Maximum operating temperature with no voltage derating		+85 °C																
Rated Voltage (V.DC)		4 6.3 10 16 20 25	at 85°C															
Category Voltage (V.DC)		2.5 4 6.3 10 13 16	at 125°C															
Surge Voltage		5.2 8 13 20 26 32	at 85°C															
DC leakage current		0.5μA or 0.01CV whichever is greater (Shown in "Standard list")	As per 4.9 JIS C 5101-1 As per 4.5.1 JIS C 5101-3 Voltage : Rated voltage for 1 min															
Capacitance tolerance		Shall be satisfied allowance range. ±10%, ±20%	As per 4.7 JIS C 5101-1 As per 4.5.2 JIS C 5101-3 Measuring frequency : 120±12Hz Measuring voltage : 0.5Vrms, +1.5V.DC Measuring circuit : DC Equivalent series circuit															
Tangent of loss angle (Df, tanδ)		Shall be satisfied the voltage on "Standard list"	As per 4.8 JIS C 5101-1 As per 4.5.3 JIS C 5101-3 Measuring frequency : 120±12Hz Measuring voltage : 0.5Vrms, +1.5V.DC Measuring circuit : DC Equivalent series circuit															
Impedance		Shall be satisfied the voltage on "Standard list"	As per 4.10 JIS C 5101-1 As per 4.5.4 JIS C 5101-3 Measuring frequency : 100±10kHz Measuring voltage : 0.5Vrms or less Measuring circuit : DC Equivalent series circuit															
Resistance to soldering heat	Appearance	There should be no significant abnormality. The indications should be clear.	As per 4.14 JIS C 5101-1 As per 4.6 JIS C 5101-3 Dip in the solder bath Solder temp : 260±5°C Duration : 5±0.5s Repetition : 1															
	L.C	Less than initial limit																
	ΔC / C	Within ±10% of initial value																
	tanδ	Less than 150% of initial limit																
Fail-Safe open unit actuation		Within 320°C – 20s	Dip in the solder bath Solder temp : 320±5°C															
Temperature cycle	Appearance	There should be no significant abnormality.	As per 4.16 JIS C 5101-1 As per 4.10 JIS C 5101-3 Repetition : 5 cycles (1 cycle : steps 1 to 4) without discontinuation.															
	L.C	Less than initial limit																
	ΔC / C	1 to 10μF : within ±10% of initial value 15 to 22μF : within ±20% of initial value																
	tanδ	Less than 150% of initial limit																
			<table border="1"> <thead> <tr> <th>Step</th> <th>Temp.</th> <th>Time</th> </tr> </thead> <tbody> <tr> <td>1</td> <td>-55±3°C</td> <td>30±3min</td> </tr> <tr> <td>2</td> <td>Room temp.</td> <td>3min. or less</td> </tr> <tr> <td>3</td> <td>125±2°C</td> <td>30±3min</td> </tr> <tr> <td>4</td> <td>Room temp.</td> <td>3min. or less</td> </tr> </tbody> </table>	Step	Temp.	Time	1	-55±3°C	30±3min	2	Room temp.	3min. or less	3	125±2°C	30±3min	4	Room temp.	3min. or less
Step	Temp.	Time																
1	-55±3°C	30±3min																
2	Room temp.	3min. or less																
3	125±2°C	30±3min																
4	Room temp.	3min. or less																
Moisture resistance	Appearance	There should be no significant abnormality. The indications should be clear.	As per 4.22 JIS C 5101-1 As per 4.12 JIS C 5101-3 After leaving the sample under such atmospheric condition that the temperature and humidity are 60±2°C and 90 to 95%RH, respectively, for 500±12h level it at room temperature for 1 to 2h and then measure the sample.															
	L.C	Less than initial limit																
	ΔC / C	Within ±20% of initial value																
	tanδ	Less than 150% of initial limit																

Tantalum capacitors

Item	Performance	Test conditions (based on JIS C5101-1 and JIS C5101-3)
Temperature Stability	Temp.	-55°C
	$\Delta C / C$	Within 0/-15% of initial value
	$\tan \delta$	Shall be satisfied the voltage on "Standard list"
	L.C	-
	Temp.	+85°C
	$\Delta C / C$	Within +15/0% of initial value
	$\tan \delta$	Shall be satisfied the voltage on "Standard list"
	L.C	5 μ A or 0.1CV whichever is greater
	Temp.	+125°C
	$\Delta C / C$	Within +20/0% of initial value
Surge Voltage	Appearance	There should be no significant abnormality.
	L.C	Shall be satisfied the voltage on "Standard list"
	$\Delta C / C$	Within $\pm 10\%$ of initial value
	$\tan \delta$	Less than 150% of initial limit
Loading at High temperature	Appearance	There should be no significant abnormality.
	L.C	Less than initial limit
	$\Delta C / C$	Within $\pm 10\%$ of initial value
	$\tan \delta$	Less than 150% of initial limit
Terminal Strength	Capacitance	The measured value should be stable.
	Appearance	There should be no significant abnormality.
Adhesiveness		

As per 4.29 JIS C 5101-1
As per 4.13 JIS C 5101-3

As per 4.26 JIS C 5101-1
As per 4.14 JIS C 5101-3
Apply the specified surge voltage every 5 \pm 0.5min. for 30 \pm 5 s. each time in the atmospheric condition of 85 \pm 2°C.
Repeat this procedure 1,000 times.

As per 4.23 JIS C 5101-1
As per 4.15 JIS C 5101-3
After applying the rated voltage for 1000+36/0h without discontinuation via the serial resistance of 3 Ω or less at a temperature of 85 \pm 2°C, leave the sample at room temperature/humidity for 1 to 2h and measure the value.

As per 4.35 JIS C 5101-1
As per 4.9 JIS C 5101-3
A force is applied to the terminal until it bends to 1mm and by a prescribed tool maintain the condition for 5s. (See the figure below.)

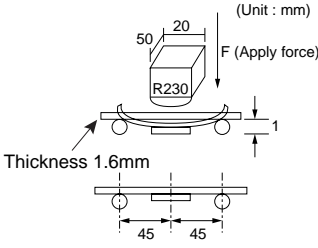

(Unit : mm)

Thickness 1.6mm

As per 4.34 JIS C 5101-1
As per 4.8 JIS C 5101-3
Apply force of 5N in the two directions shown in the figure below for 10 \pm 1s after mounting the terminal on a circuit board.

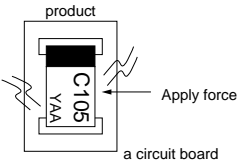

Tantalum capacitors

Item		Performance	Test conditions (based on JIS C5101-1 and JIS C5101-3)
Dimensions		Be based on "External dimensions"	Measure using a caliper of JIS B 7505 Class 2 or higher grade.
Resistance to solvents		The indication should be clear.	As per 4.32 JIS C 5101-1 As per 4.18 JIS C 5101-3 Dip in the isopropyl alcohol for 30±5s, at room temperature.
Solderability		3/4 or more surface area of the solder coated terminal dipped in the soldering bath should be covered with the new solder.	As per 4.15.2 JIS C 5101-1 As per 4.7 JIS C 5101-3 Dip speed = 25±2.5mm/s Pre-treatment (accelerated aging) : Leave the sample on the boiling distilled water for 1h. Solder temp. : 235±5°C Duration : 2±0.5s Solder : H63A Flux : Rosin 25%, IPA 75%
Vibration	Capacitance	Measure value should not fluctuate during the measurement.	As per 4.17 JIS C 5101-1 Frequency : 10 to 55 to 10Hz/min. Amplitude : 1.5mm Time : 2h each in X and Y directions Mounting : The terminal is soldered on a print circuit board.
	Appearance	There should be no significant abnormality.	

Tantalum capacitors

●Table 1 standard list, TCFG series P Case

(P : 2012)

Part No.	Rated Voltage @85°C (V)	Derated Voltage @125°C (V)	Surge Voltage @85°C (V)	Capacitance 120Hz (μF)	Tolerance (%)	Leakage current 25°C 1WV.60s (mA)	DF120Hz (%)			Impedance 100kHz (Ω)	Case code
							-55°C	25°C 85°C	125°C		
TCFG P 0G 225□	4	2.5	5.2	2.2	±20,±10	0.5	15	10	15	4.0	P
TCFG P 0G 335□	4	2.5	5.2	3.3	±20,±10	0.5	30	20	30	17.5	P
TCFG P 0G 475□	4	2.5	5.2	4.7	±20,±10	0.5	30	20	30	14.4	P
TCFG P 0G 685□	4	2.5	5.2	6.8	±20,±10	0.5	30	20	30	11.8	P
TCFG P 0G 106□	4	2.5	5.2	10	±20,±10	0.5	30	20	30	9.3	P
TCFG P 0G 156□	4	2.5	5.2	15	±20,±10	0.6	30	20	30	8.3	P
TCFG P 0G 226□	4	2.5	5.2	22	±20,±10	0.9	30	20	30	7.7	P
TCFG P 0J 155 □	6.3	4	8	1.5	±20,±10	0.5	15	10	15	17.5	P
TCFG P 0J 225□	6.3	4	8	2.2	±20,±10	0.5	30	20	30	4.0	P
TCFG P 0J 335□	6.3	4	8	3.3	±20,±10	0.5	30	20	30	14.4	P
TCFG P 0J 475□	6.3	4	8	4.7	±20,±10	0.5	30	20	30	11.8	P
TCFG P 0J 685□	6.3	4	8	6.8	±20,±10	0.5	30	20	30	9.3	P
TCFG P 0J 106□	6.3	4	8	10	±20,±10	0.6	30	20	30	8.3	P
TCFG P 0J 156□	6.3	4	8	15	±20,±10	0.9	30	20	30	7.7	P
TCFG P 1A 105□	10	6.3	13	1.0	±20,±10	0.5	15	10	15	17.5	P
TCFG P 1A 155□	10	6.3	13	1.5	±20,±10	0.5	30	20	30	16.1	P
TCFG P 1A 225□	10	6.3	13	2.2	±20,±10	0.5	30	20	30	4.0	P
TCFG P 1A 335□	10	6.3	13	3.3	±20,±10	0.5	30	20	30	11.8	P
TCFG P 1A 475□	10	6.3	13	4.7	±20,±10	0.5	30	20	30	6.0	P
TCFG P 1C 105□	16	10	20	1.0	±20,±10	0.5	15	10	15	16.5	P
TCFG P 1D 105□	20	13	26	1.0	±20,±10	0.5	15	10	15	16.1	P
TCFG P 1E 105 □	25	16	33	1.0	±20,±10	0.5	15	10	15	16.1	P

□=Tolerance (M : ±20%, K : ±10%)

●Packaging specifications

Case code	A±0.1	B±0.1	t ₁ ±0.05	t ₂ ±0.1
P (2012)	1.55	2.3	0.25	1.5

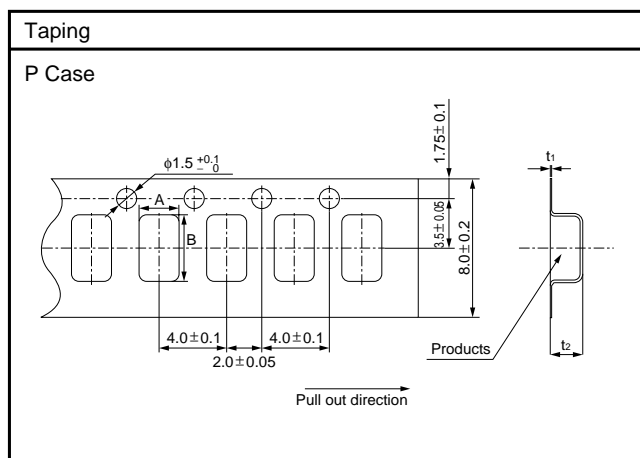

Tantalum capacitors

●Packaging style

Case size	Packaging	Packaging style		Symbol	Basic ordering unit
P Case	Taping	Plastic taping	φ180mm reel	R	2,000

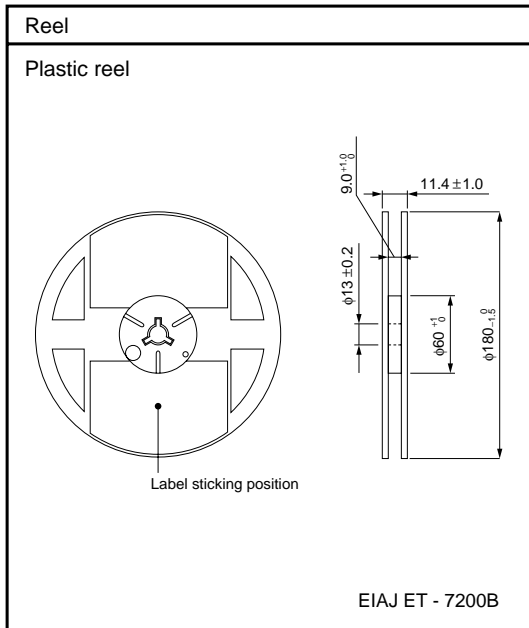

Tantalum capacitors

● Recommended condition of reflow soldering

(1) Soldering Conditions

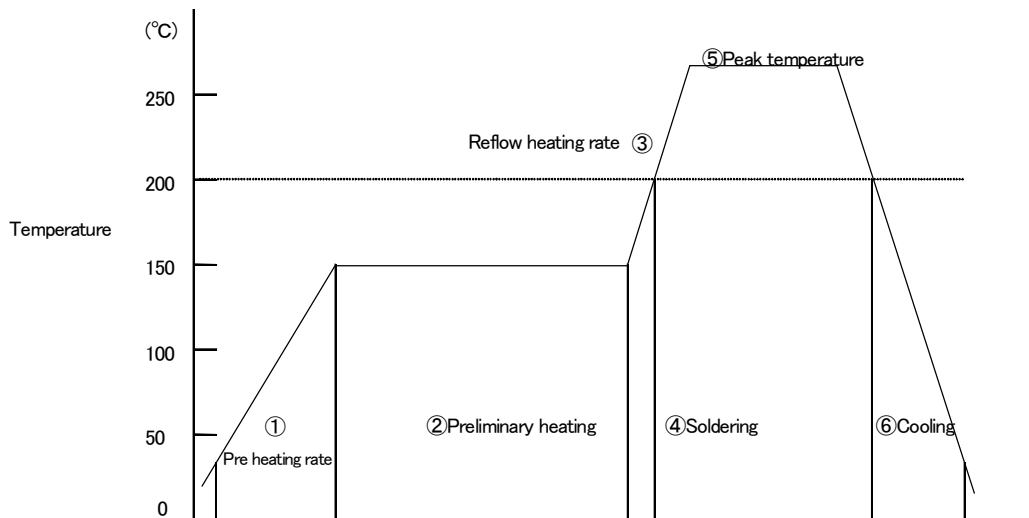

Recommended condition of reflow soldering

- ① Pre heating rate : 1 to 5°C / s
- ② Preliminary heating : 120 to 160°C, 50 to 120s
- ③ Reflow heating rate : 1 to 5°C / s
- ④ Soldering : 200°C, 30 to 60s
- ⑤ Peak temperature : 230 to 260°C 10s Max.
- ⑥ Cooling : 60s Min.
- ⑦ Time : 2times Max.

Recommended condition of hand soldering

- ① Temperature (30W Max.) : 300°C Max.
- ② Time : 5s Max.

Flow soldering (Dip • Wave soldering)

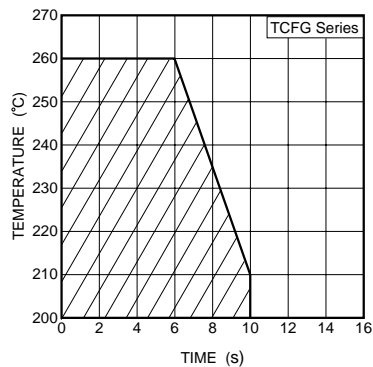

Fig.1

Tantalum capacitors

(2) Leakage current-to-voltage ratio

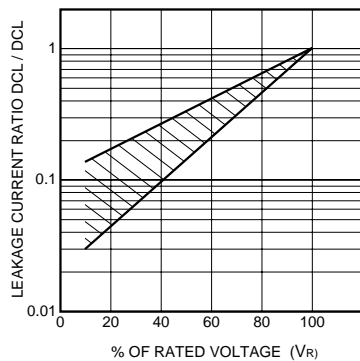

Fig.2

(3) Derating voltage as function of temperature

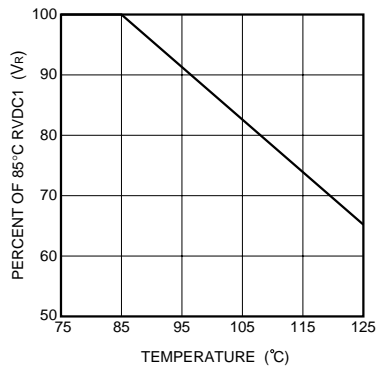

Fig.3

85°C		125°C	
Rated Voltage (V.DC)	Surge Voltage (V.DC)	Category Voltage (V.DC)	Surge Voltage (V.DC)
4	5.0	2.5	3.4
6.3	8	4	5
10	13	6.3	9
16	20	10	12
20	26	13	16

(4) Reliability

The malfunction rate of tantalum solid state electrolytic capacitors varies considerably depending on the conditions of usage (ambient temperature, applied voltage, circuit resistance).

Formula for calculating malfunction rate

$$\lambda_p = \lambda_b \times (\pi_E \times \pi_{SR} \times \pi_Q \times \pi_{CV})$$

- λ_p : Malfunction rate stemming from operation
- λ_b : Basic malfunction rate
- π_E : Environmental factors
- π_{SR} : Series resistance
- π_Q : Level of malfunction rate
- π_{CV} : Capacitance

For details on how to calculate the malfunction rate stemming from operation, see the tantalum solid state electrolytic capacitors column in MIL-HDBK-217.

Tantalum capacitors

Malfunction rate as function of operating temperature and rated voltage

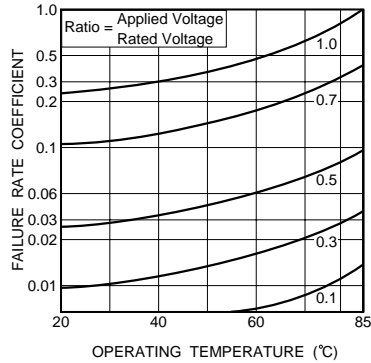

Fig.4

Malfunction rate as function of circuit resistance (Ω/V)

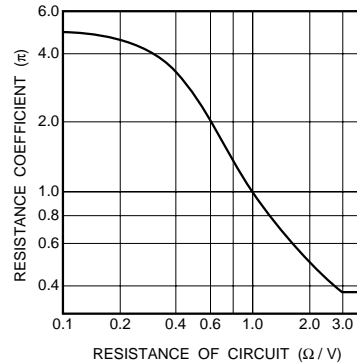

Fig.5

(5) External temperature vs. fuse blowout

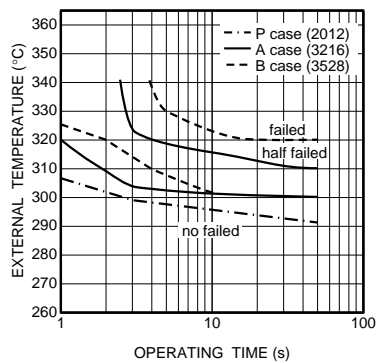

Fig.6

(6) Power vs. fuse blowout characteristics / Product surface temperature

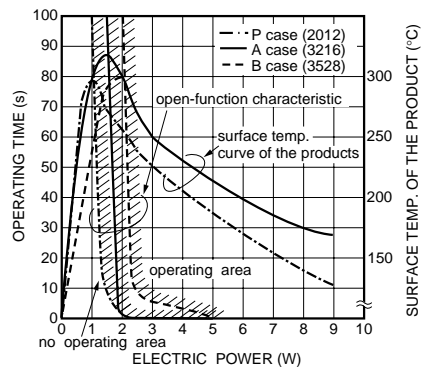

Fig.7

Note: Solder the chip at 300°C or less. If it is soldered using a temperature higher than 300°C, open function built-in may operate.

(7) Maximum power dissipation

Warming of the capacitor due to ripple voltage balances with warming caused by Joule heating and by radiated heat. Maximum allowable warming of the capacitor is to 5°C above ambient temperature. When warming exceeds 5°C, it can damage the dielectric and cause a short circuit.

$$\text{Power dissipation (P)} = I^2 \cdot R$$

Ripple current

P : As shown in table at right

R : Equivalent series resistance

Notes:

1. Please be aware that when case size is changed, maximum allowable power dissipation is reduced.
2. Maximum power dissipation varies depending on the package. Be sure to use a case which will keep warming within the limits shown in the table below.

Tantalum capacitors

Allowable power dissipation (W) and maximum temperature rising

Case \ Ambient temp	+25°C	+55°C	+85°C	+125°C
P case (2012)	0.025	0.022	0.020	0.010
Max. Temp Rise (°C)	5	5	5	2

(8) Impedance frequency characteristics

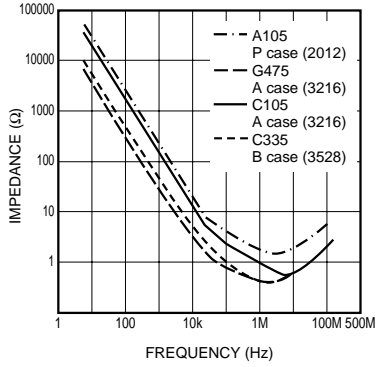

Fig.8

(9) ESR frequency characteristics

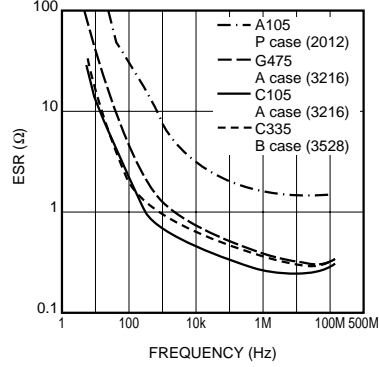

Fig.9

(10) Temperature characteristics

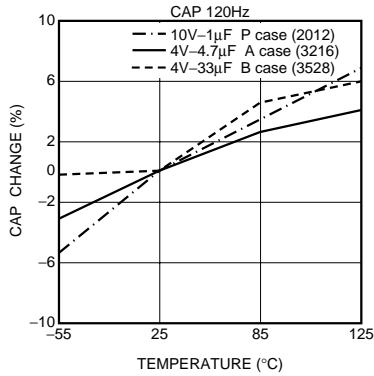

Fig.10

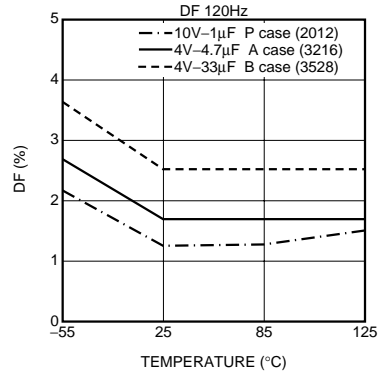

Fig.11

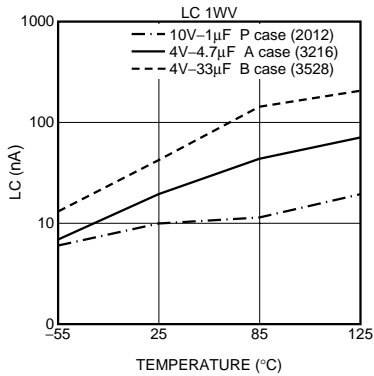

Fig.12

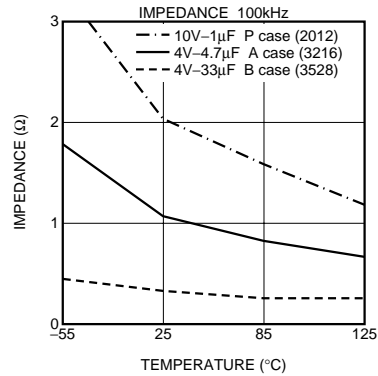

Fig.13

Tantalum capacitors

Inrush current

Beware of inrush current.
Inrush currents are inversely proportional ESR. Large inrush currents can cause components failure.

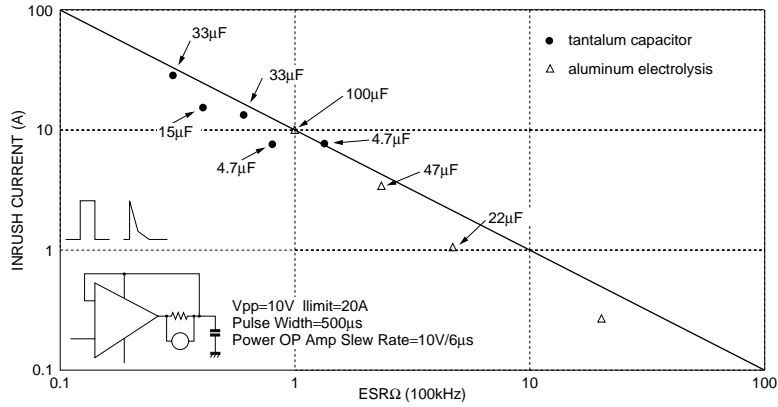

Fig. 14 Maximum inrush current and ESR

Inrush current can be limited by means of a protective resistor.

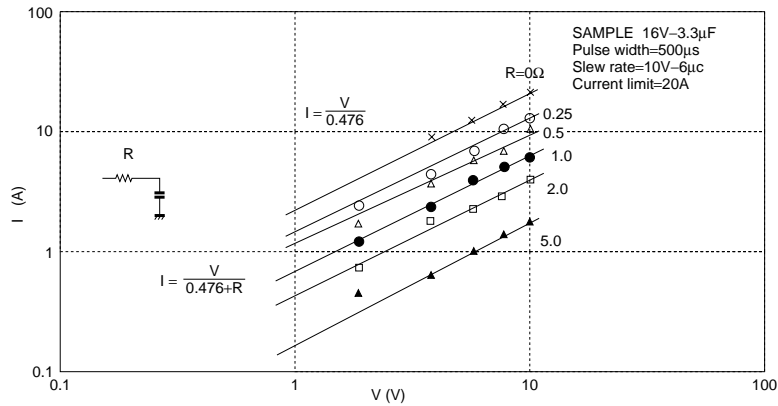

Fig. 15 I_{max} change due to protective resistor R

(11) Ultrasonic cleaning

Carry out cleaning under as mild conditions as possible. The internal element of a tantalum capacitor are larger than those of a transistor or diode, so it is not as resistant as ultrasonic waves.

Example : water
 Propagation speed 1500m / s
 Solvent density 1g / cm³

Frequency and wavelength

Frequency	Wavelength
20kHz	7.5cm
28kHz	5.3cm
50kHz	3.0cm

Tantalum capacitors

● Precautions

- 1) Do not allow solvent to come to a boil (kinetic energy increases).
 - . Ultrasonic output 0.5W / cm² or less
 - . Use a solvent with a high boiling point.
 - . Lower solvent temperature.
- 2) Ultrasonic cleaning frequency
28 kHz or less
- 3) Keep cleaning time as short as possible.
- 4) Move item being cleaned.
Standing waves caused by the ultrasonic waves can cause stress to build up in part of the item being cleaned.

Reference

$$\text{Kinetic energy} = 2 \times \pi \times \text{frequency} \times \sqrt{\frac{2 \times \text{Ultrasonic output}}{\text{propagation} \times \text{speed} \times \text{solvent density}}}$$

Notes

- No technical content pages of this document may be reproduced in any form or transmitted by any means without prior permission of ROHM CO.,LTD.
- The contents described herein are subject to change without notice. The specifications for the product described in this document are for reference only. Upon actual use, therefore, please request that specifications to be separately delivered.
- Application circuit diagrams and circuit constants contained herein are shown as examples of standard use and operation. Please pay careful attention to the peripheral conditions when designing circuits and deciding upon circuit constants in the set.
- Any data, including, but not limited to application circuit diagrams information, described herein are intended only as illustrations of such devices and not as the specifications for such devices. ROHM CO.,LTD. disclaims any warranty that any use of such devices shall be free from infringement of any third party's intellectual property rights or other proprietary rights, and further, assumes no liability of whatsoever nature in the event of any such infringement, or arising from or connected with or related to the use of such devices.
- Upon the sale of any such devices, other than for buyer's right to use such devices itself, resell or otherwise dispose of the same, no express or implied right or license to practice or commercially exploit any intellectual property rights or other proprietary rights owned or controlled by
- ROHM CO., LTD. is granted to any such buyer.
- Products listed in this document are no antiradiation design.

The products listed in this document are designed to be used with ordinary electronic equipment or devices (such as audio visual equipment, office-automation equipment, communications devices, electrical appliances and electronic toys).

Should you intend to use these products with equipment or devices which require an extremely high level of reliability and the malfunction of which would directly endanger human life (such as medical instruments, transportation equipment, aerospace machinery, nuclear-reactor controllers, fuel controllers and other safety devices), please be sure to consult with our sales representative in advance.

About Export Control Order in Japan

Products described herein are the objects of controlled goods in Annex 1 (Item 16) of Export Trade Control Order in Japan.

In case of export from Japan, please confirm if it applies to "objective" criteria or an "informed" (by MITI clause) on the basis of "catch all controls for Non-Proliferation of Weapons of Mass Destruction.