

Features

- Universal AC input (85-264VAC)
- Protections: SCP, OVP, OLP, OTP
- DC OK indicator LED with relay contacts
- 150% (720W) peak load capacity
- Built-in active PFC, PF>0.95
- High efficiency up to 93.8%

DIN Rail Series

RECOM AC/DC Converter

REDIN480

480 Watt DIN-Rail Power Supply



Description

These DIN-rail mounted power supplies have a robust case, 4mm screw terminal connectors and use high reliability components to give a long, trouble-free life. The REDIN480 can be end mounted to save rail space or side mounted for use in low-profile cabinets. The units can deliver up to 150% start-up power and allow n+1 parallel operation to increase the continuous output current or for supply redundancy. Relay contacts simplify DC OK monitoring. The REDIN480 series is designed for demanding commercial and industrial applications with UL508, UL60950, IEC60950 CB report and CE (LVD + EMC + RoHS) certifications. They come with a full 5-year warranty.

Selection Guide

Part Number	nom. Input Voltage Range [VAC]	Output Voltage [VDC]	Output Adjustability [VDC]	Rated Current [A]	Efficiency typ. [%]
REDIN480-24	100-240	24	24-28	20	93.8
REDIN480-48	100-240	48	48-56	10	93.5



Specifications (measured @ Ta = 25°C, rated Vin, rated load and after warm up)

BASIC CHARACTERISTICS					
Parameter	Condition		Min.	Typ.	Max.
Input Voltage Range			85VAC		264VAC
Absolute Maximum Input Voltage	max. 3s				300VAC
Input Current	full load, 115VAC full load, 230VAC			4.59A 2.36A	7.0A 3.5A
Inrush Current	cold start at 25°C, 115VAC cold start at 25°C, 230VAC			6.8A 13A	20A 40A
No Load Power Consumption	85-264VAC 230VAC			3.85W 2.85W	5W 4W
Input Frequency Range			47Hz		63Hz
Power Factor	115VAC 230VAC			0.99 0.95	
Start-up time	24Vout	115VAC 230VAC		1.6s 1.3s	3s
	48Vout	115VAC 230VAC		1.5s 1.3s	3s
Hold-up time	24Vout	230VAC	20ms	21ms	
	48Vout		20ms	22ms	
Rise time	24Vout	230VAC		31ms	100ms
	48Vout			49ms	100ms
Ripple & Noise ⁽¹⁾	0 - 70°C -25°C	24Vout			240mVp-p 480mVp-p
	-25 - 70°C	48Vout			480mVp-p
<p>Notes:</p> <p>Note1: Measured at 20MHz bandwidth by using a 12" twisted pair-wire terminated with a 0.1µF & 10µF parallel capacitor</p>					

continued on next page



UL60950-1 certified
UL508 certified
IEC/EN60950-1 certified

Specifications (measured @ $T_a = 25^\circ\text{C}$, rated V_{in} , rated load and after warm up)

REDIN480-24

Efficiency vs Load

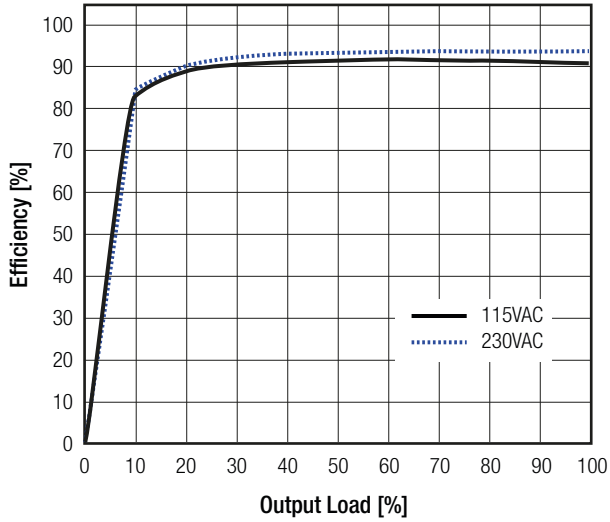

Power Dissipation vs Load

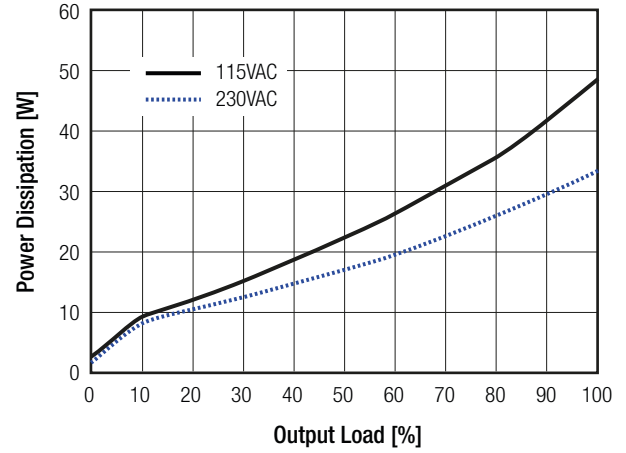

Input Current vs Load

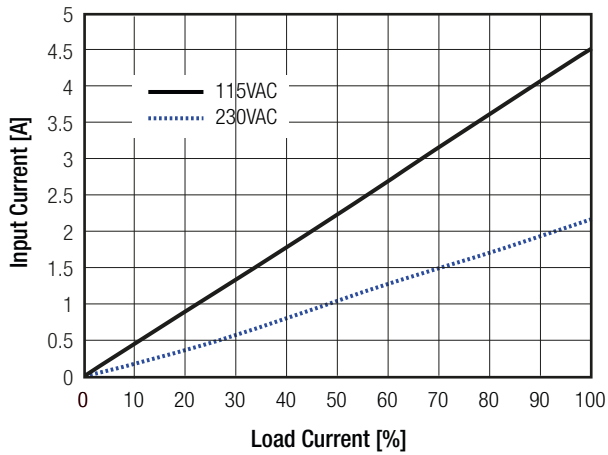

Power Factor vs Load over V_{in}

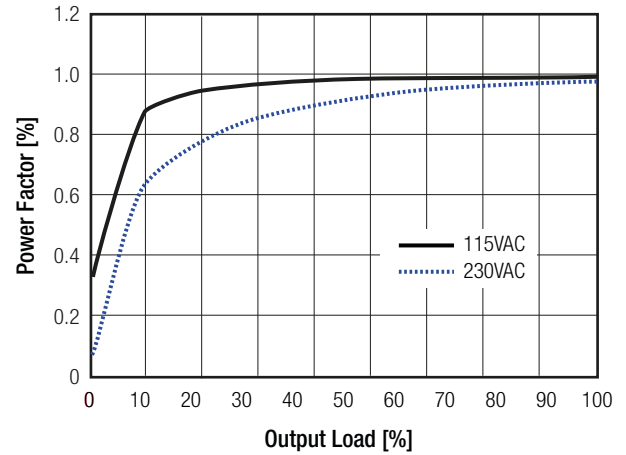

REGULATION

Parameter	Condition	Value
Output Accuracy	24Vout	$\pm 0.6\%$ typ. / $\pm 3.0\%$ max.
	48Vout	$\pm 0.5\%$ typ. / $\pm 3.0\%$ max.
Line Regulation	24Vout, 48Vout	$\pm 0.1\%$ typ. / $\pm 0.5\%$ max.
Load Regulation	0% to 100% load	0.3% typ. / 1.0% max.
Transient Response	100Hz & 1kHz, 50% duty, 25% load step change	$\pm 2.0\%$ typ. / $\pm 5.0\%$ max.

Specifications (measured @ Ta = 25°C, rated Vin, rated load and after warm up)

PROTECTION			
Parameter	Condition		Value
Input Fuse ⁽²⁾			T10A, slow blow type
Short Circuit Protection (SCP)			Hiccup Mode
Over Voltage Protection (OVP)	24Vout 48Vout		29-33VDC, constant voltage auto recovery 58-63VDC, constant voltage auto recovery
Over Voltage Category (OVC)			OVC II
Over Load Protection (OLP)			Limit the current by constant power circuit
Over Temperature Protection (OTP)			115±5°C, detect on Heat-sink of power transistor; shut down O/P, auto recovery after temperature goes down
Isolation Voltage	tested for 1 minute	I/P to O/P I/P to PE O/P to PE	3.0kVAC / 15mA max. 2.5kVAC / 15mA max. 0.5kVAC / 20mA max.
Isolation Resistance			10MΩ min.
Insulation Grade			reinforced
Leakage Current	I/P to O/P I/P to PE		0.25mA max. 3.5mA max.
Power OK LED	ON (green) OFF (red) Relay Contact Rating		Vout up to 90% of rated Vout Vout down to 80% of rated Vout Max. 30V/1A or 60V/0.3 or 30VAC/0.3A Resistive Load

Notes:

Note2: Refer to local wiring regulations if input over-current protection is also required

Overload Capability

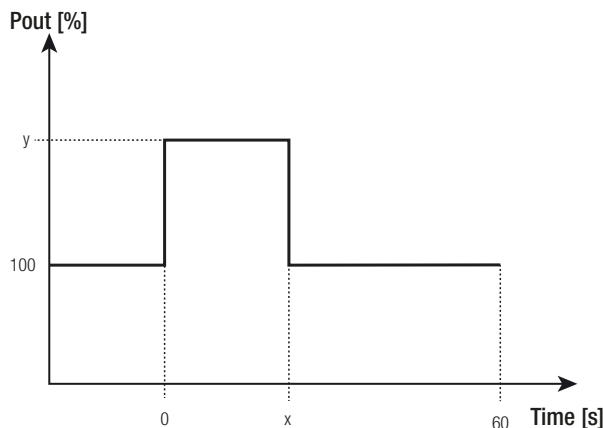

ENVIRONMENTAL

Parameter	Condition		Value
Operating Temperature Range	@ natural convection 0.1m/s	full load	-25°C to +50°C
		refer to derating graph	-25°C to +70°C
Temperature Coefficient			0.03%/K
Operating Humidity	non-condensing		20% - 90% RH
IP Rating			IP X0
Pollution Degree (PD)			PD2
Shock			10-500Hz 2G, 60min.
Vibration			10G /11ms, along x,y and z axis
MTBF	according to MIL-HDBK-217F G.B., 25°C		300 x 10 ³ hours

continued on next page

Specifications (measured @ Ta = 25°C, rated Vin, rated load and after warm up)

Thermal Derating

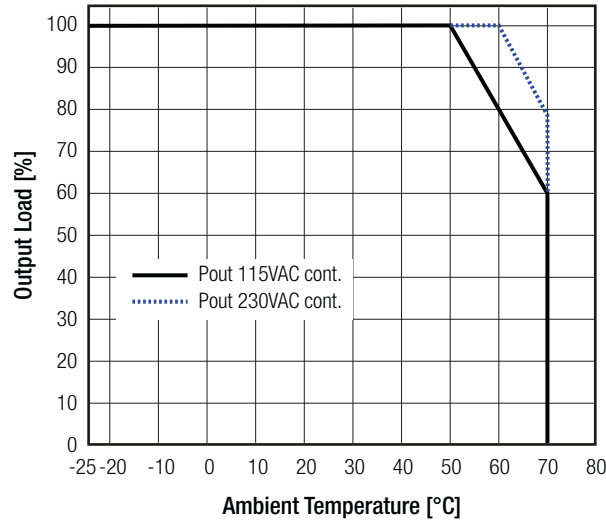

SAFETY AND CERTIFICATIONS

Certificate Type	Report / File Number	Standard
Information Technology Equipment, General Requirements for Safety	E224736 A52	UL60950-1, 2nd Edition, 2014 CSA C22.2 No. 60950-1-07, 2nd Edition, 2014
Industrial Control Equipment	E470721 Vol3 Sec1	UL508, 17th Edition, 2013 CSA C22.2 No. 107.1-01, 3rd Edition, 2011
Information Technology Equipment - General Requirements for Safety (CB Scheme)	16BAS06033 11	IEC60950-1, 2nd Edition:2005, +AM1:2009 + AM2:2013 EN60950-1:2006+ A11:2009 + A1:2010 + A12:2011 + A2:2013
EAC	RU-AT.37.02367	TP TC 004/2011
RoHs 2		RoHs 2011/65/EU

EMC Compliance	Report / Condition	Standard / Criterion
Information technology equipment - Radio disturbance characteristics - Limits and methods of measurement		EN55022:2010 + AC:2011, Class B
Information technology equipment - Immunity characteristics - Limits and methods of measurement		EN55024:2010 + A1:2015
Limitations on the amount of electromagnetic interference allowed from digital and electronic devices		47 CFR FCC Part 15, Subpart B, 2016
Methods of Measurement of Radio-Noise Emissions from Low-Voltage Electrical and Electronic Equipment in the Range of 9 kHz to 40 GHz		ANSI C63.4, 2014
ESD Electrostatic discharge immunity test	Air ±8kV, Contact ±4kV	EN61000-4-2, Criteria B
Radiated, radio-frequency, electromagnetic field immunity test	3V/m	EN61000-4-3, Criteria A
Fast Transient and Burst Immunity	AC Power Port: ±1kV	EN61000-4-4, Criteria B
Surge Immunity	AC Power Port L-N ±1kV, L-PE + N-PE ±2kV	EN61000-4-5, Criteria B
Immunity to conducted disturbances, induced by radio-frequency fields	AC Power Port 3V	EN61000-4-6, Criteria A
Power Magnetic Field Immunity	50Hz, 1A/m	EN61000-4-8, Criteria A
Voltage Dips and Interruptions	Voltage Dips >95%	EN61000-4-11, Criteria B
	Voltage Dips 30%	EN61000-4-11, Criteria C
	Voltage Interruptions >95%	EN61000-4-11, Criteria C
Limits of Harmonic Current Emissions		EN61000-3-2:2014, Criteria A
Voltage Fluctuations & Flicker		EN61000-3-3:2013

Specifications (measured @ Ta = 25°C, rated Vin, rated load and after warm up)

DIMENSION and PHYSICAL CHARACTERISTICS

Parameter	Type	Value
Material	case cover	aluminium nickel plated steel
Dimension (LxWxH)		122.3 x 71.0 x 124.2mm
Weight		1.185kg typ.

Dimension Drawing (mm)

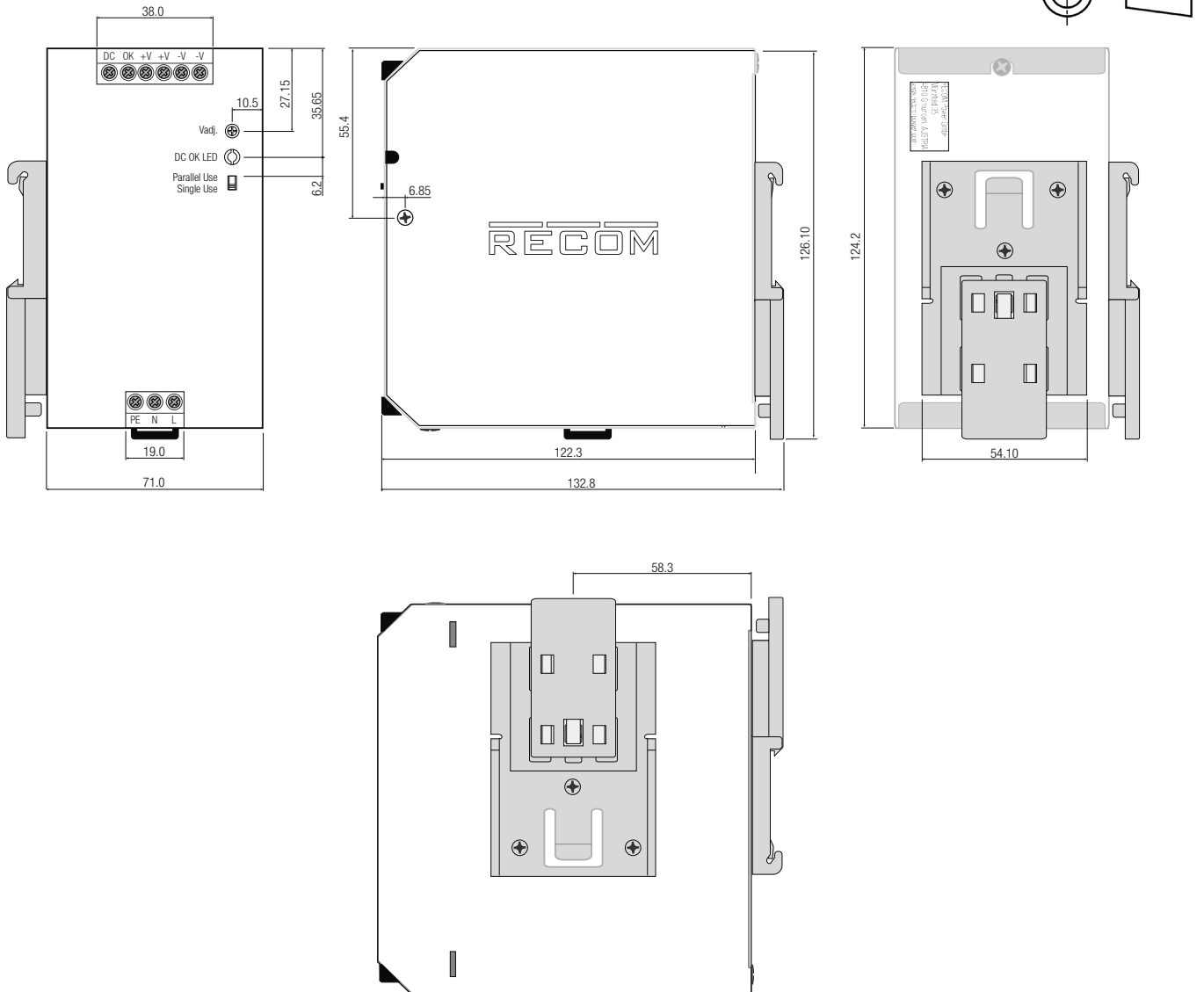

Terminals and Wiring

Type	Screw Connector
Solid Wire	1-6mm ²
Stranded Wire	1-4mm ²
American Wire Gauge	AWG17-10
Wire Stripping Length	8mm
Screwdriver (slotted / cross)	3.5mm
Recommended tightening torque	0.5Nm-0.8Nm
Tolerance: X.X ±0.5mm X.XX ±0.25mm	

Specifications (measured @ Ta = 25°C, rated Vin, rated load and after warm up)

INSTALLATION

Mounting Instruction

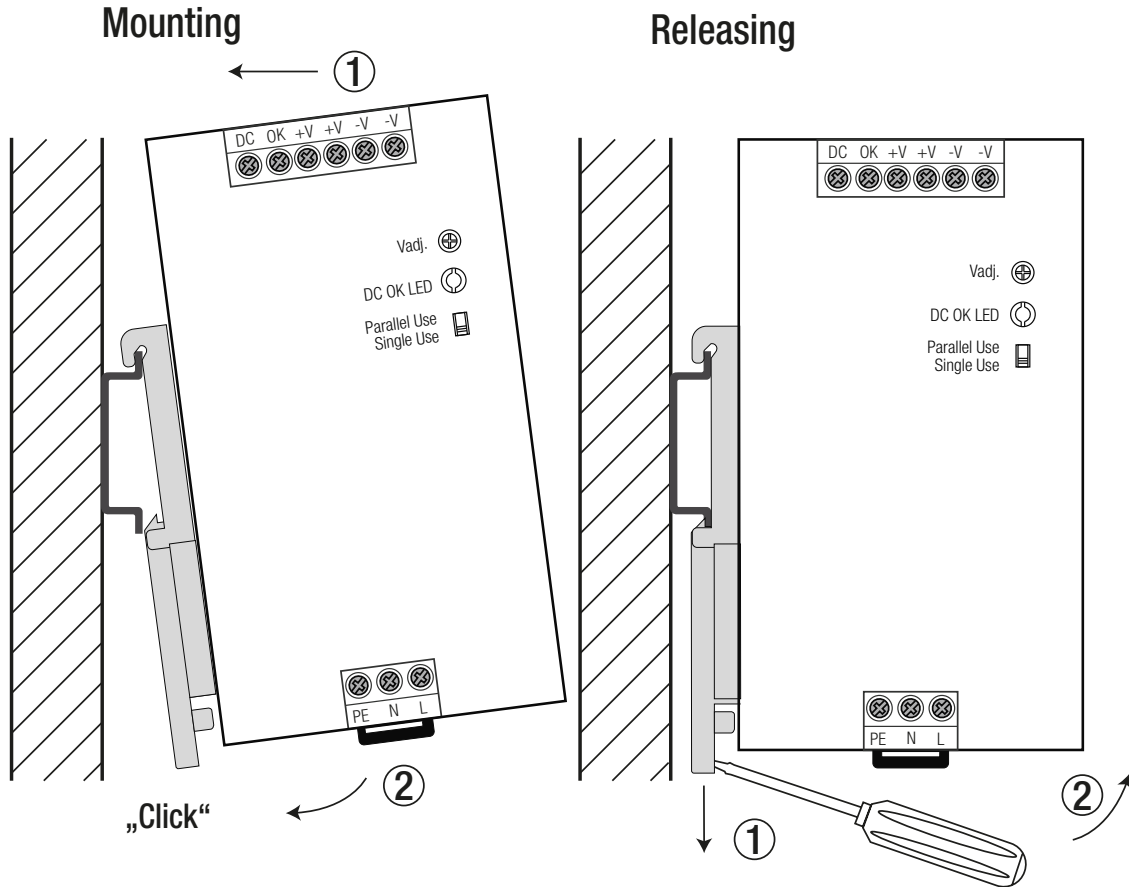

Mounting Multiple Power Supplies

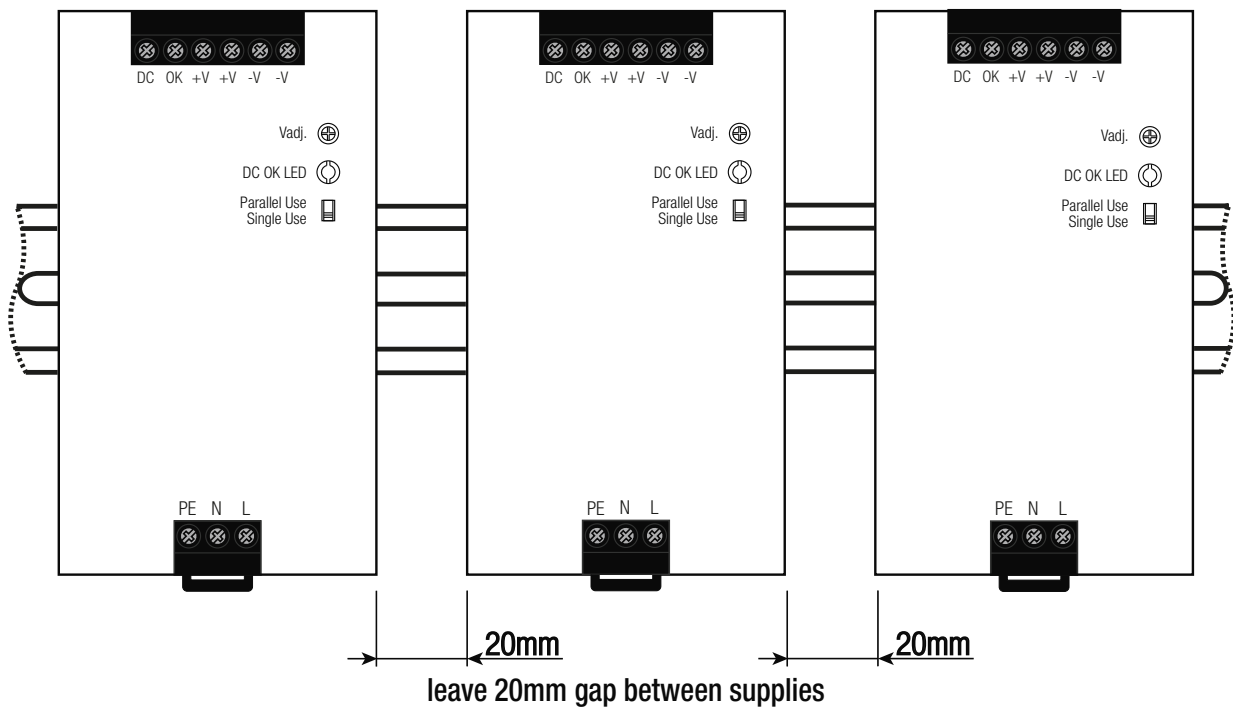

Specifications (measured @ $T_a = 25^\circ\text{C}$, rated V_{in} , rated load and after warm up)

Parallel Operation & Phase Redundancy

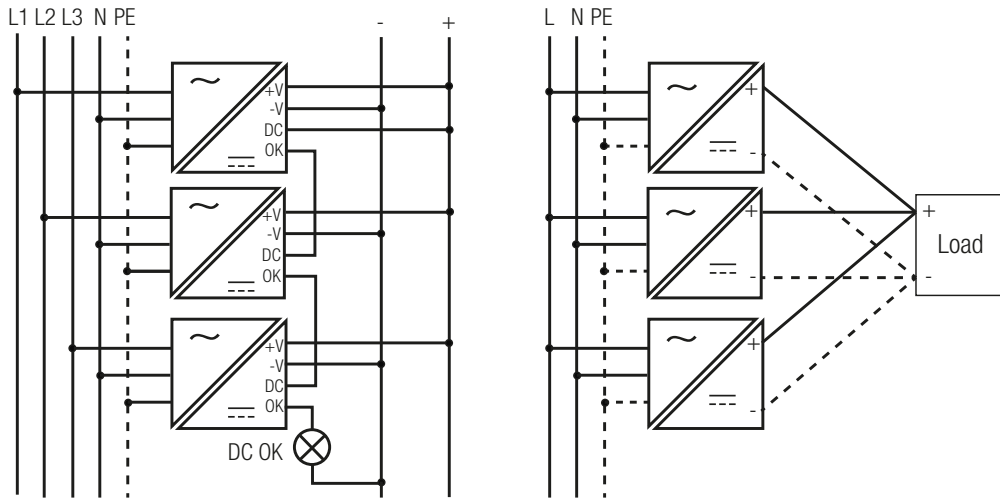

Single Operation:

- 1) Make sure that the front panel switch is set to "single Use."
- 2) The output voltage can be increased by trim pot to compensate any cable losses.

Parallel Operation:

- 1) Make sure that the front panel switch is set to "single Use" on each power supply.
- 2) Adjust each power supply to the exact same output voltage with same load and cooling conditions.
- 3) Set the front panel switches to "Parallel Use." Use the same wire length for each power supply (star connection) and energize all units at the same time to avoid triggering overload protection.

Derate the maximum output power to 90% of nominal ratings.

For operation with more than three power supplies in parallel or series operation, please contact RECOM technical support for advice.

BLOCK DIAGRAMM

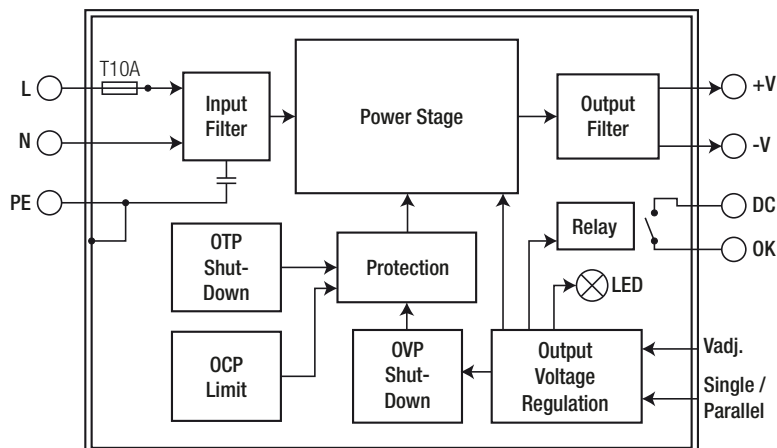

PACKAGING INFORMATION

Parameter	Type	Value
Packaging Dimension (LxWxH)	cardboard box	140.0 x 88.0 x 142.0mm
Packaging Quantity	cardboard box	1pcs
Storage Temperature Range		-40°C to +85°C
Storage Humidity		5% - 95% RH

The product information and specifications may be subject to changes even without prior written notice. The product has been designed for various applications; its suitability lies in the responsibility of each customer. The products are not authorized for use in safety-critical applications without RECOM's explicit written consent. A safety-critical application is an application where a failure may reasonably be expected to endanger or cause loss of life, inflict bodily harm or damage property. The applicant shall indemnify and hold harmless RECOM, its affiliated companies and its representatives against any damage claims in connection with the unauthorized use of RECOM products in such safety-critical applications.