

# NCP4588

## 200 mA, Output Capacitor Free, LDO Linear Voltage Regulator

The NCP4588 is a CMOS 200mA LDO which is stable without an output capacitor. This results in a reduction in component count, cost and board area, as well as contributing to a more robust solution in hostile environments. With quiescent current  $< 9.5 \mu\text{A}$  and PSRR  $> 60 \text{ dB}$ , the device is an excellent trade off between the two features. The family is available in a variety of packages: SC-70, SOT23 and a small, ultra thin  $1.2 \times 1.2 \times 0.4 \text{ mm}$  XDFN.

### Features

- Operating Input Voltage Range: 1.4 V to 5.25 V
- Output Voltage Range: 1.0 to 4.2 V (available in 0.1 V steps)
- Output Voltage Accuracy: 1%
- Quiescent Current:  $9.5 \mu\text{A}$
- Standby Current:  $0.1 \mu\text{A}$
- Very Low Dropout: 270 mV ( $I_{\text{OUT}} = 200 \text{ mA}$ ,  $V_{\text{IN}} = 3.0 \text{ V}$ )
- High PSRR: 70 dB at 1 kHz,  $V_{\text{OUT}} \leq 1.2 \text{ V}$   
65 dB at 1 kHz,  $1.2 < V_{\text{OUT}} < 2.2 \text{ V}$   
60 dB at 1 kHz,  $V_{\text{OUT}} \geq 2.2 \text{ V}$
- Line Regulation 0.02%/V Typ.
- Current Fold Back Protection: 50 mA at short
- Stable with no Output Capacitor
- Available in SC-70, XDFN and SOT23 Package
- These are Pb-Free Devices

### Typical Applications

- Battery Powered Equipments
- Portable Communication Equipments
- Cameras, VCRs and Camcorders

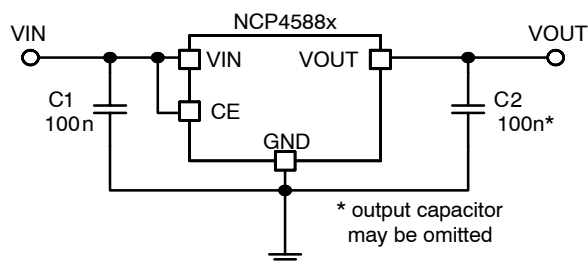

Figure 1. Typical Application Schematic



ON Semiconductor™

<http://onsemi.com>

### MARKING DIAGRAMS



SC-70  
CASE 419A

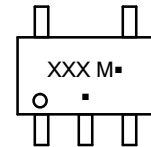

XDFN6  
CASE 711AA

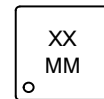

SOT-23-5  
CASE 1212

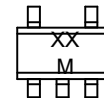

XX, XXX= Specific Device Code  
M, MM = Date Code  
A = Assembly Location  
Y = Year  
W = Work Week  
▪ = Pb-Free Package

(Note: Microdot may be in either location)

### ORDERING INFORMATION

See detailed ordering and shipping information in the package dimensions section on page 14 of this data sheet.

# NCP4588

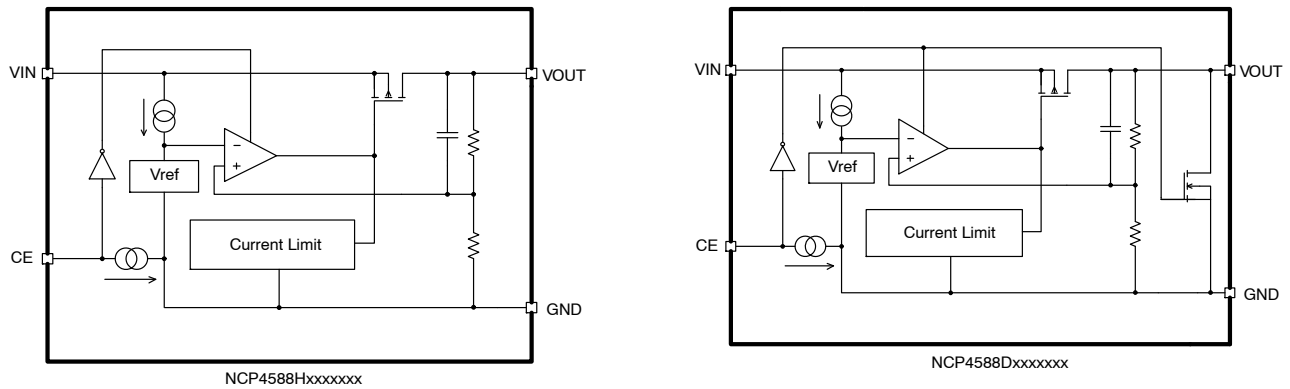

Figure 2. Simplified Schematic Block Diagram

## PIN FUNCTION DESCRIPTION

Pin No. XDFN	Pin No. SC-70	Pin No. SOT23	Pin Name	Description
4	5	1	VIN	Input pin
2	3	2	GND	Ground
3	1	3	CE	Chip enable pin (Active "H")
6	4	5	VOUT	Output pin
1, 5	2	4	NC	No connection

## ABSOLUTE MAXIMUM RATINGS

Rating	Symbol	Value	Unit
Input Voltage (Note 1)	$V_{IN}$	6.0	V
Output Voltage	$V_{OUT}$	-0.3 to $V_{IN} + 0.3$	V
Chip Enable Input	$V_{CE}$	-0.3 to 6.0	V
Output Current	$I_{OUT}$	400	mA
Power Dissipation XDFN	$P_D$	400	mW
Power Dissipation SC70		380	
Power Dissipation SOT23		420	
Junction Temperature	$T_J$	-40 to 150	°C
Storage Temperature	$T_{STG}$	-55 to 125	°C
ESD Capability, Human Body Model (Note 2)	$ESD_{HBM}$	2000	V
ESD Capability, Machine Model (Note 2)	$ESD_{MM}$	200	V

Stresses exceeding Maximum Ratings may damage the device. Maximum Ratings are stress ratings only. Functional operation above the Recommended Operating Conditions is not implied. Extended exposure to stresses above the Recommended Operating Conditions may affect device reliability.

1. Refer to ELECTRICAL CHARACTERISTICS and APPLICATION INFORMATION for Safe Operating Area.
2. This device series incorporates ESD protection and is tested by the following methods:  
 ESD Human Body Model tested per AEC-Q100-002 (EIA/JESD22-A114)  
 ESD Machine Model tested per AEC-Q100-003 (EIA/JESD22-A115)  
 Latchup Current Maximum Rating tested per JEDEC standard: JESD78.

# NCP4588

## THERMAL CHARACTERISTICS

Rating	Symbol	Value	Unit
Thermal Characteristics, XDFN Thermal Resistance, Junction-to-Air	$R_{\theta JA}$	250	$^{\circ}\text{C}/\text{W}$
Thermal Characteristics, SOT23 Thermal Resistance, Junction-to-Air	$R_{\theta JA}$	238	$^{\circ}\text{C}/\text{W}$
Thermal Characteristics, SC-70 Thermal Resistance, Junction-to-Air	$R_{\theta JA}$	263	$^{\circ}\text{C}/\text{W}$

## ELECTRICAL CHARACTERISTICS

$-40^{\circ}\text{C} \leq T_A \leq 85^{\circ}\text{C}$ ;  $V_{IN} = V_{OUT(NOM)} + 1\text{ V}$ ;  $I_{OUT} = 1\text{ mA}$ ;  $C_{IN} = C_{OUT} = 1\text{ }\mu\text{F}$ ; unless otherwise noted. Typical values are at  $T_A = +25^{\circ}\text{C}$ .

Parameter	Test Conditions	Symbol	Min	Typ	Max	Unit	
Operating Input Voltage		$V_{IN}$	1.4		5.25	V	
Output Voltage	$T_A = +25^{\circ}\text{C}$	$V_{OUT}$	$V_{OUT} > 2.0\text{ V}$	x0.99	x1.01	V	
			$V_{OUT} \leq 2.0\text{ V}$	-20	20	mV	
	$-40^{\circ}\text{C} \leq T_A \leq 85^{\circ}\text{C}$		$V_{OUT} > 2.0\text{ V}$	x0.980	x1.015	V	
			$V_{OUT} \leq 2.0\text{ V}$	-40	30	mV	
Output Voltage Temp. Coefficient	$-40^{\circ}\text{C} \leq T_A \leq 85^{\circ}\text{C}$			$\pm 100$		ppm/ $^{\circ}\text{C}$	
Line Regulation	$V_{OUT(NOM)} + 0.5\text{ V} \leq V_{IN} \leq 5.0\text{ V}$	$\text{LineReg}$		0.02	0.2	%/V	
Load Regulation	$I_{OUT} = 1\text{ mA to } 200\text{ mA}$	$\text{LineReg}$		25	50	mV	
Dropout Voltage	$I_{OUT} = 200\text{ mA}$	$V_{DO}$	$1.0\text{ V} \leq V_{OUT} < 1.3\text{ V}$		0.64	0.92	V
			$1.1\text{ V} \leq V_{OUT} < 1.5\text{ V}$		0.59	0.84	
			$1.2\text{ V} \leq V_{OUT} < 1.8\text{ V}$		0.55	0.76	
			$1.5\text{ V} \leq V_{OUT} < 2.3\text{ V}$		0.44	0.60	
			$2.0\text{ V} \leq V_{OUT} < 3.0\text{ V}$		0.35	0.49	
			$2.6\text{ V} \leq V_{OUT} < 4.0\text{ V}$		0.27	0.36	
Output Current		$I_{OUT}$	200			mA	
Short Current Limit	$V_{OUT} = 0\text{ V}$	$I_{SC}$		50		mA	
Quiescent Current		$I_Q$		9.5	25	$\mu\text{A}$	
Standby Current	$V_{CE} = 0\text{ V}, T_A = 25^{\circ}\text{C}$	$I_{STB}$		0.1	3.0	$\mu\text{A}$	
CE Pin Threshold Voltage	CE Input Voltage "H"	$V_{CEH}$	1.0			V	
	CE Input Voltage "L"	$V_{CEL}$			0.4		
CE Pull Down Current		$I_{CEPD}$		0.1		$\mu\text{A}$	
Power Supply Rejection Ratio	$V_{IN} = V_{OUT} + 1\text{ V}$ or $2.2\text{ V}$ whichever is higher, $\Delta V_{IN} = 0.2\text{ V}_{pk-pk}$ , $I_{OUT} = 30\text{ mA}$ , $f = 1\text{ kHz}$	PSRR				dB	
			$V_{OUT} \leq 1.2\text{ V}$		70		
			$1.2\text{ V} < V_{OUT} \leq 2.2\text{ V}$		65		
			$2.2\text{ V} \leq V_{OUT}$		60		
Output Noise Voltage	$V_{OUT} = 1\text{ V}, I_{OUT} = 30\text{ mA}, f = 10\text{ Hz to } 100\text{ kHz}$	$V_N$		80		$\mu\text{V}_{rms}$	
Low Output Nch Tr. On Resistance	$V_{IN} = 4\text{ V}, V_{CE} = 0\text{ V}$ , D version only	$R_{LOW}$		30		$\Omega$	

TYPICAL CHARACTERISTICS

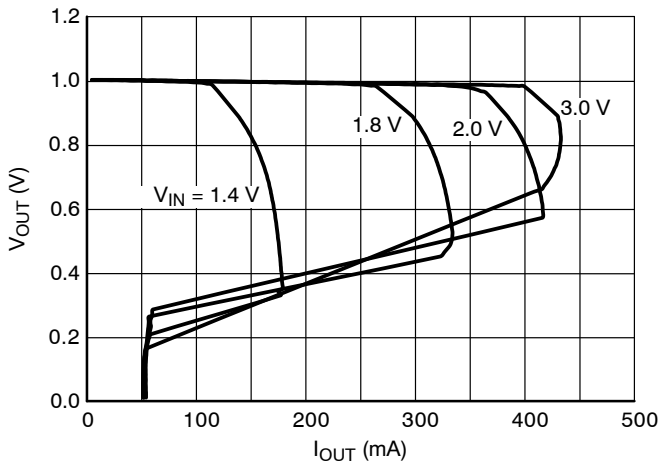

Figure 3. Output Voltage vs. Output Current  
1.0 V Version ( $T_A = 25^\circ\text{C}$ )

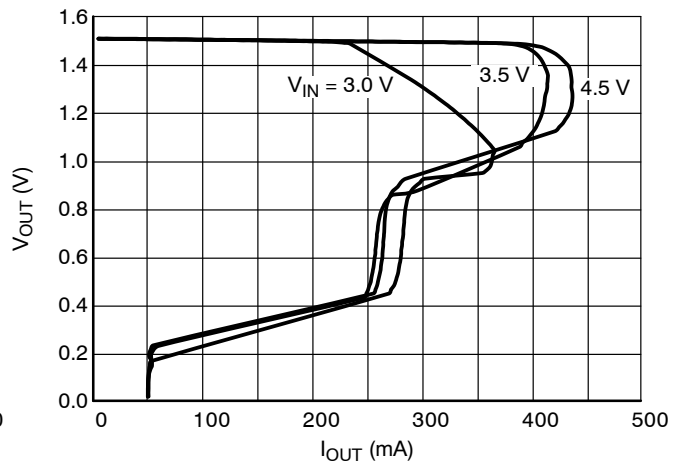

Figure 4. Output Voltage vs. Output Current  
1.5 V Version ( $T_A = 25^\circ\text{C}$ )

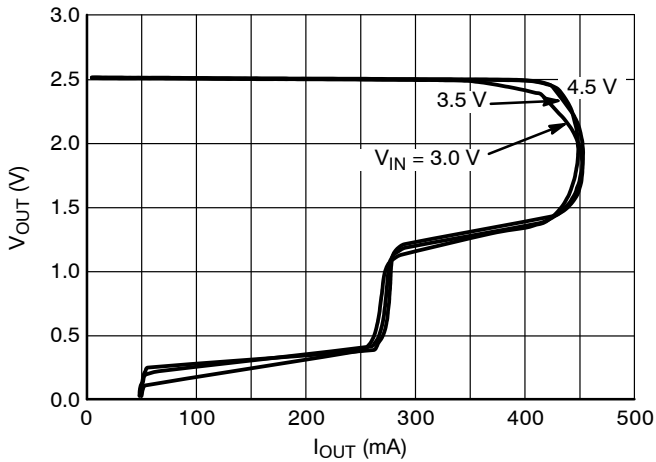

Figure 5. Output Voltage vs. Output Current  
2.5 V Version ( $T_A = 25^\circ\text{C}$ )

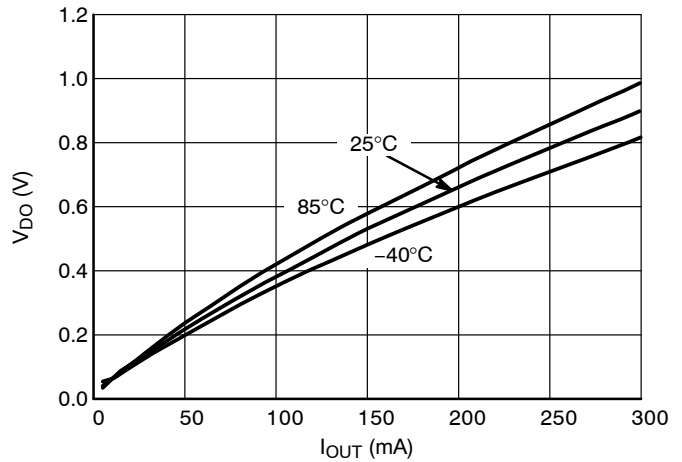

Figure 6. Dropout Voltage vs. Output Current  
1.0 V Version

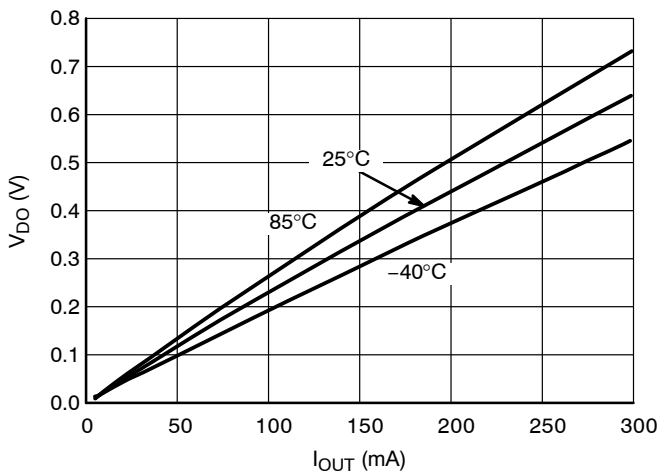

Figure 7. Dropout Voltage vs. Output Current  
1.5 V Version

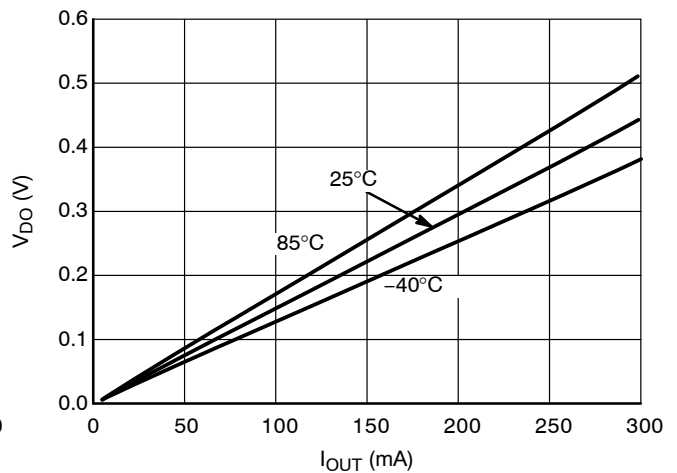

Figure 8. Dropout Voltage vs. Output Current  
2.5 V Version

TYPICAL CHARACTERISTICS

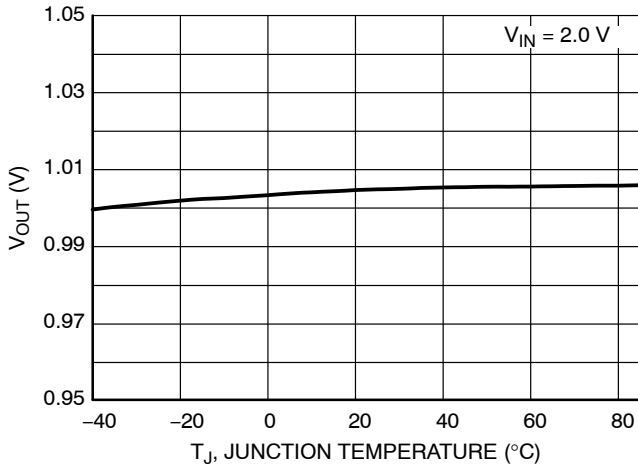

Figure 9. Output Voltage vs. Temperature, 1.0 V Version

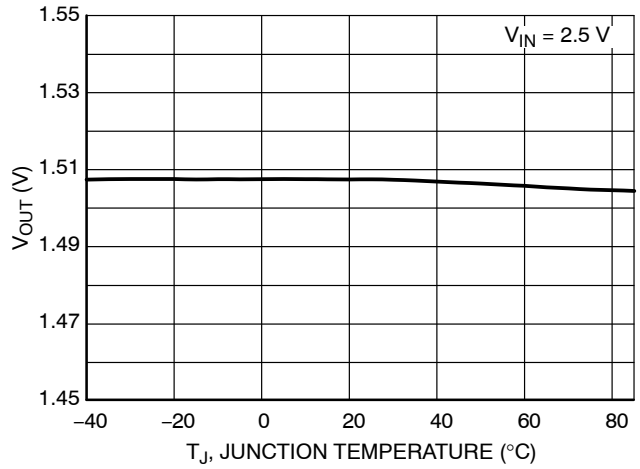

Figure 10. Output Voltage vs. Temperature, 1.5 V Version

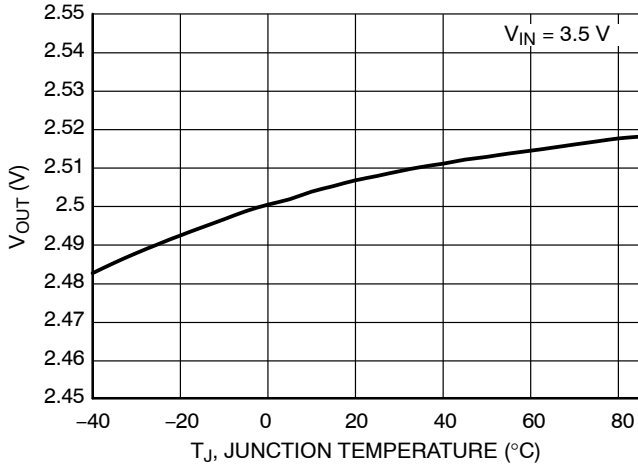

Figure 11. Output Voltage vs. Temperature, 2.5 V Version

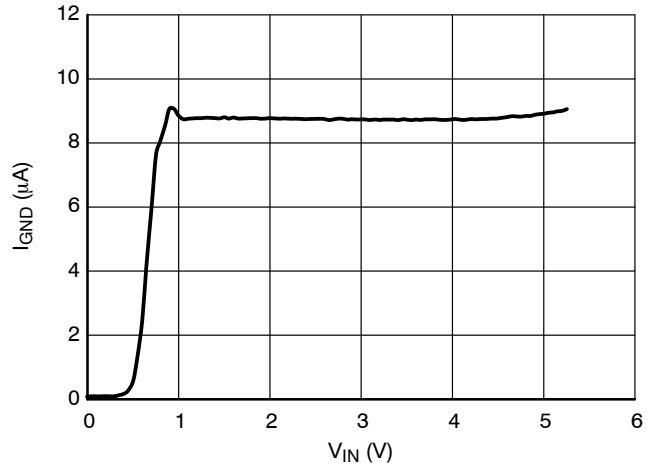

Figure 12. Supply Current vs. Input Voltage, 1.0 V Version

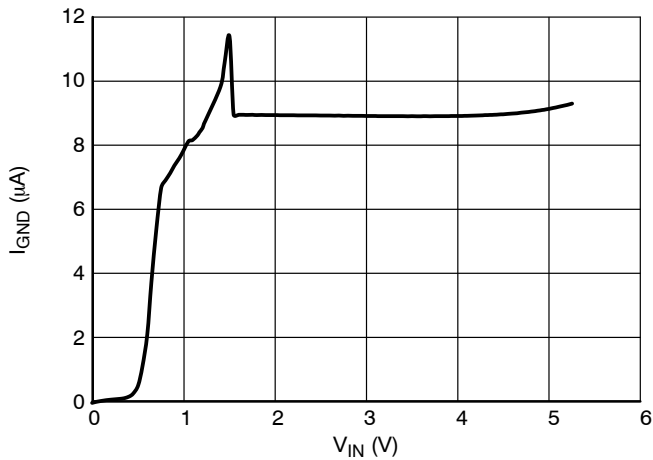

Figure 13. Supply Current vs. Input Voltage, 1.5 V Version

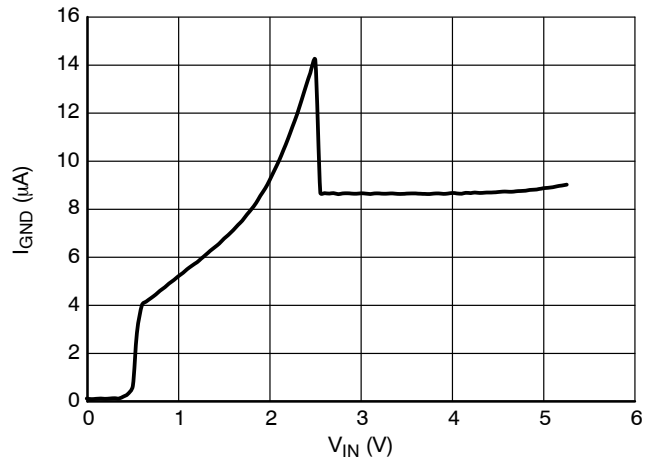
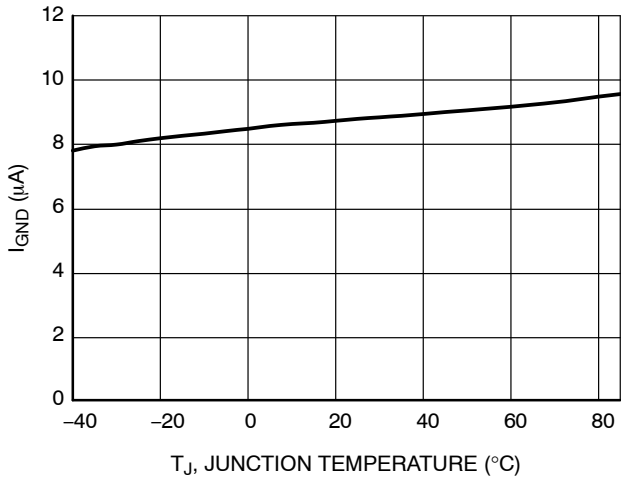

Figure 14. Supply Current vs. Input Voltage, 2.5 V Version

# NCP4588

## TYPICAL CHARACTERISTICS



**Figure 15. Supply Current vs. Temperature, 1.0 V Version**

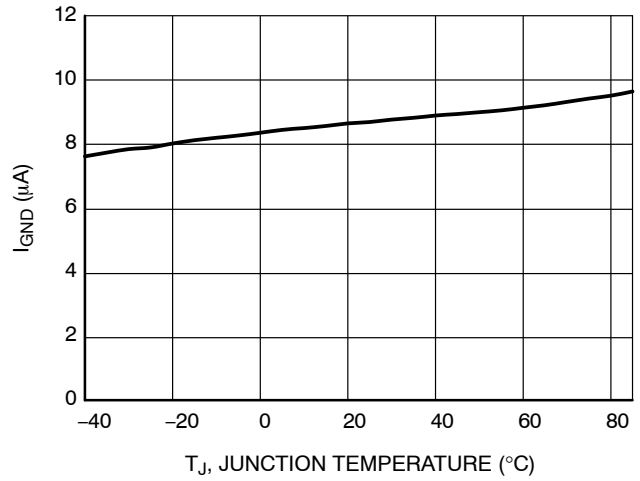

**Figure 16. Supply Current vs. Temperature, 1.5 V Version**

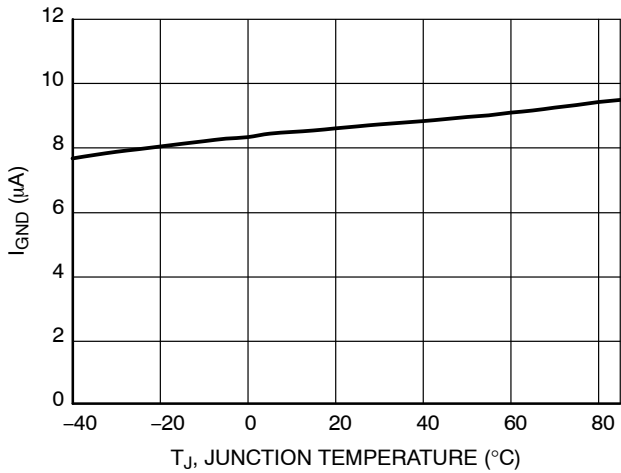

**Figure 17. Supply Current vs. Temperature, 2.5 V Version**

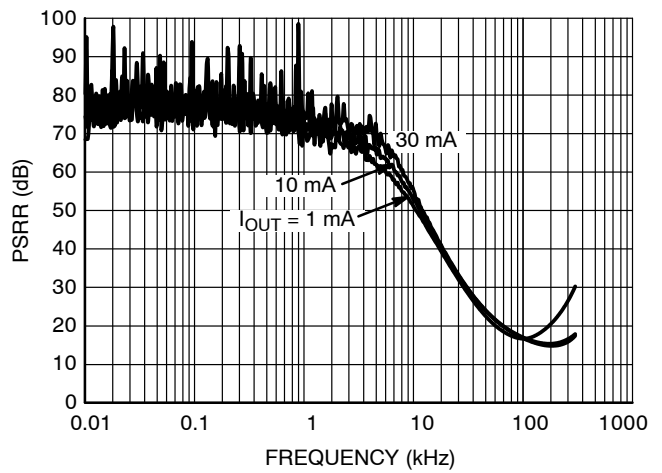

**Figure 18. PSRR, 1.0 V Version, C<sub>OUT</sub> = 100 nF**

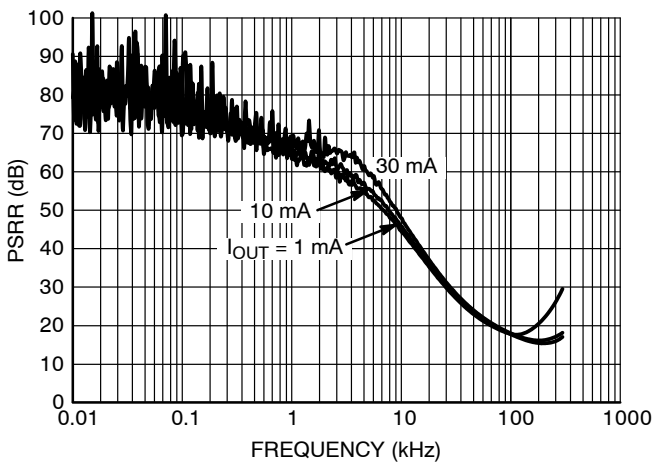

**Figure 19. PSRR, 1.5 V Version, C<sub>OUT</sub> = 100 nF**

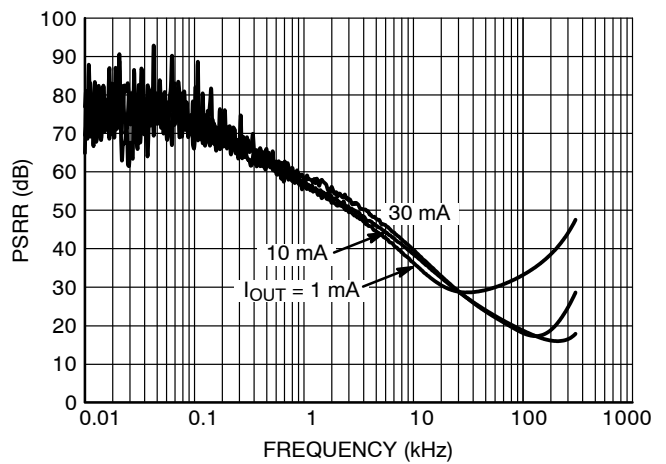

**Figure 20. PSRR, 2.5 V Version, C<sub>OUT</sub> = 100 nF**

TYPICAL CHARACTERISTICS

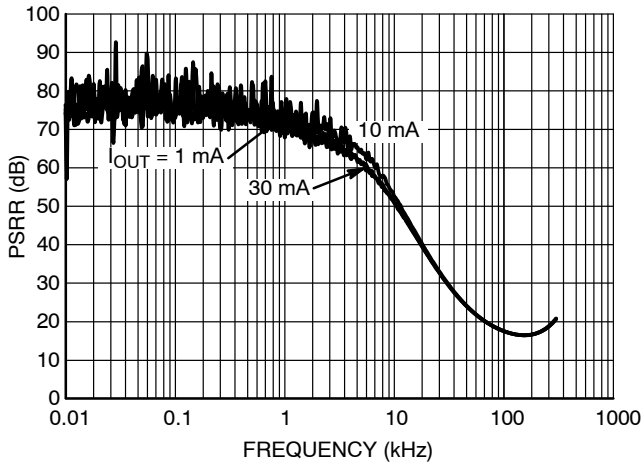

Figure 21. PSRR, 1.0 V Version,  $C_{OUT} = 0 \mu F$

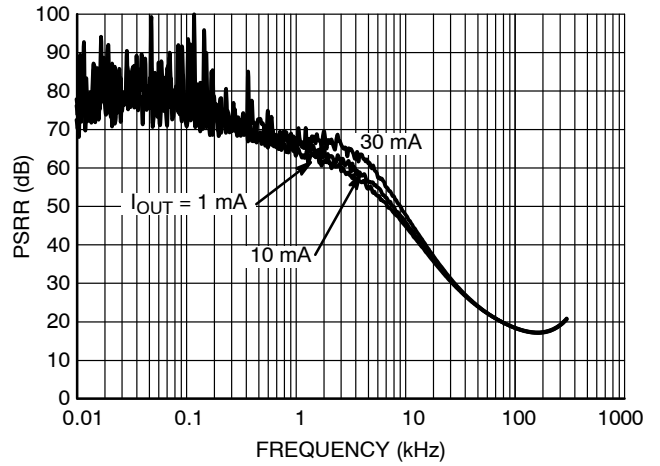

Figure 22. PSRR, 1.5 V Version,  $C_{OUT} = 0 \mu F$

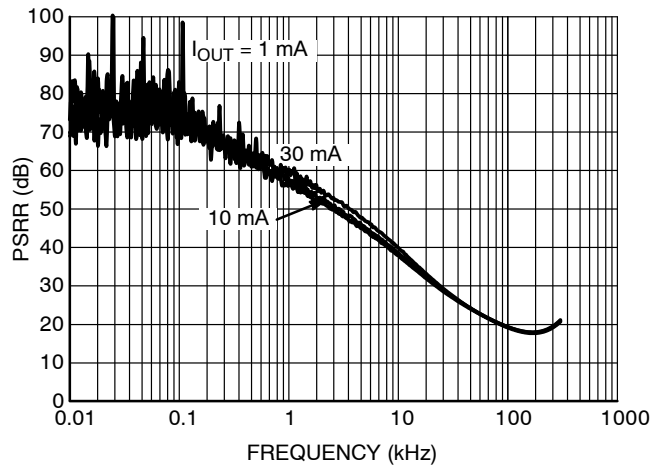

Figure 23. PSRR, 2.5 V Version,  $C_{OUT} = 0 \mu F$

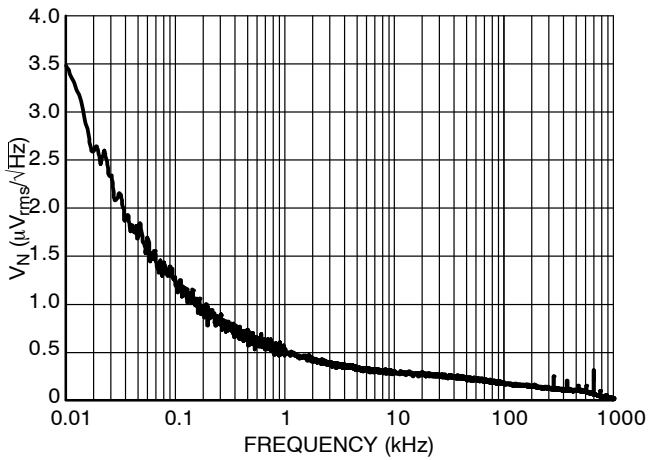

Figure 24. Output Voltage Noise, 1.0 V Version

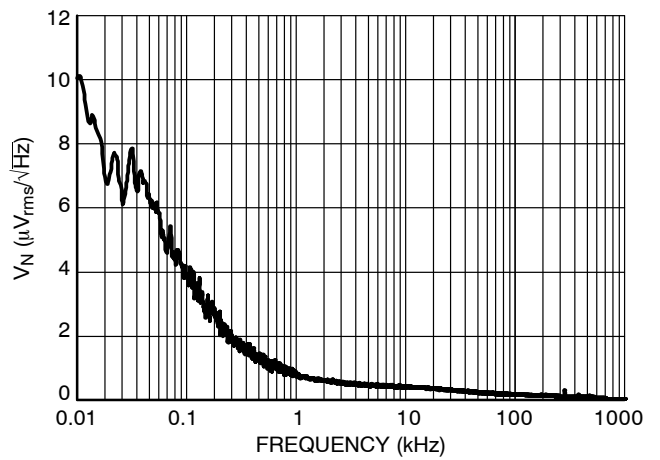

Figure 25. Output Voltage Noise, 1.5 V Version

# NCP4588

## TYPICAL CHARACTERISTICS

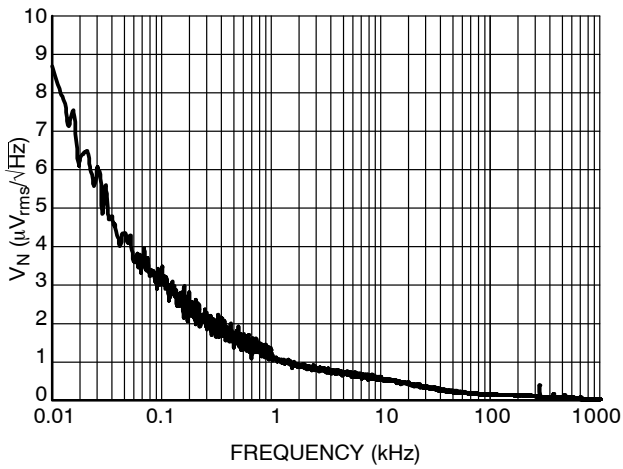

Figure 26. Output Voltage Noise, 2.5 V Version

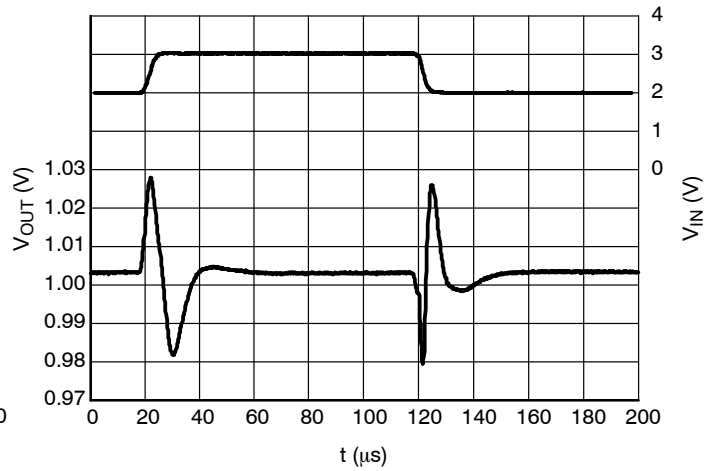

Figure 27. Line Transients, 1.0 V Version,  
 $t_R = t_F = 5 \mu\text{s}$ ,  $I_{OUT} = 30 \text{ mA}$ ,  $C_{OUT} = 0 \text{ nF}$

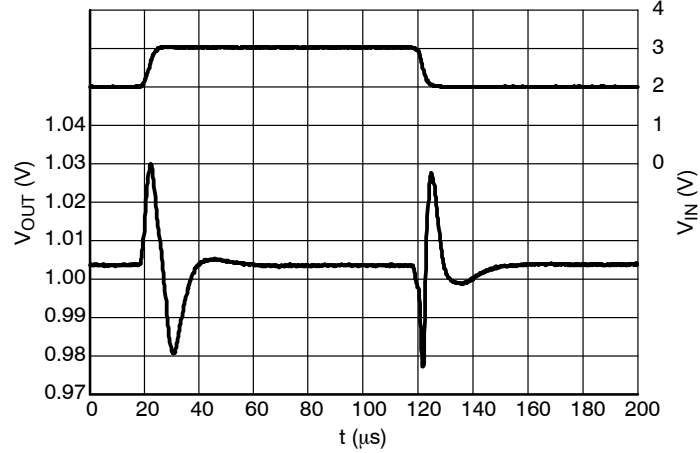

Figure 28. Line Transients, 1.0 V Version,  
 $t_R = t_F = 5 \mu\text{s}$ ,  $I_{OUT} = 30 \text{ mA}$ ,  $C_{OUT} = 100 \text{ nF}$

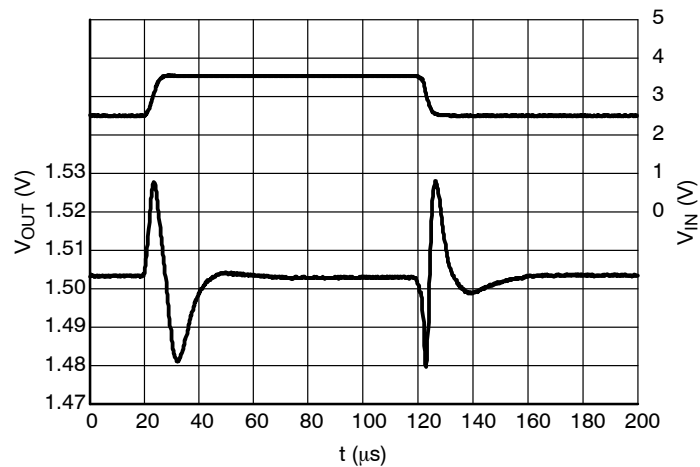
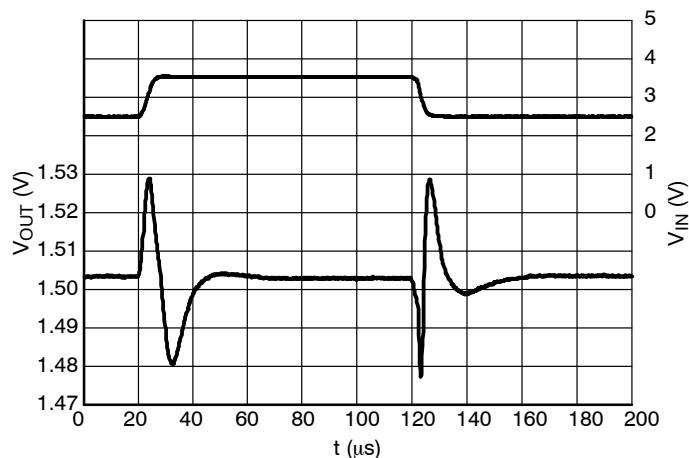

Figure 29. Line Transients, 1.5 V Version,  
 $t_R = t_F = 5 \mu\text{s}$ ,  $I_{OUT} = 30 \text{ mA}$ ,  $C_{OUT} = 0 \text{ nF}$



# NCP4588

## TYPICAL CHARACTERISTICS



**Figure 30. Line Transients, 2.5 V Version,  
 $t_R = t_F = 5 \mu$ s,  $I_{OUT} = 30$  mA,  $C_{OUT} = 100$  nF**

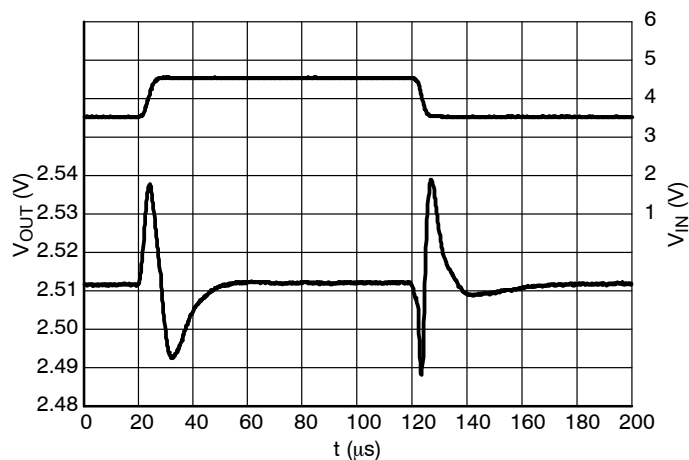

**Figure 31. Line Transients, 2.5 V Version,  
 $t_R = t_F = 5 \mu$ s,  $I_{OUT} = 30$  mA,  $C_{OUT} = 0$  nF**

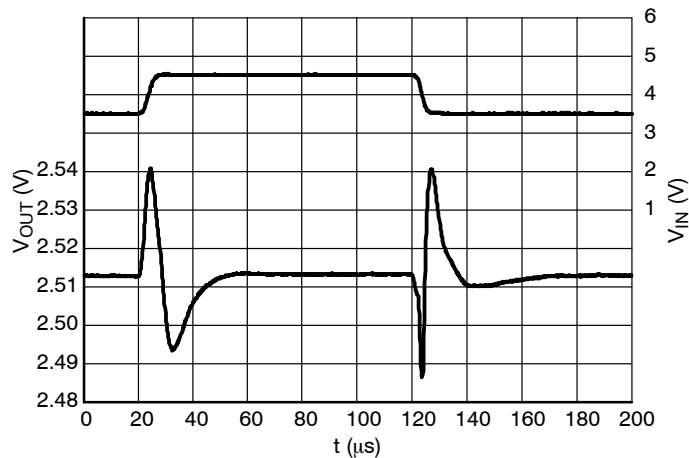

**Figure 32. Line Transients, 2.5 V Version,  
 $t_R = t_F = 5 \mu$ s,  $I_{OUT} = 30$  mA,  $C_{OUT} = 100$  nF**

# NCP4588

## TYPICAL CHARACTERISTICS

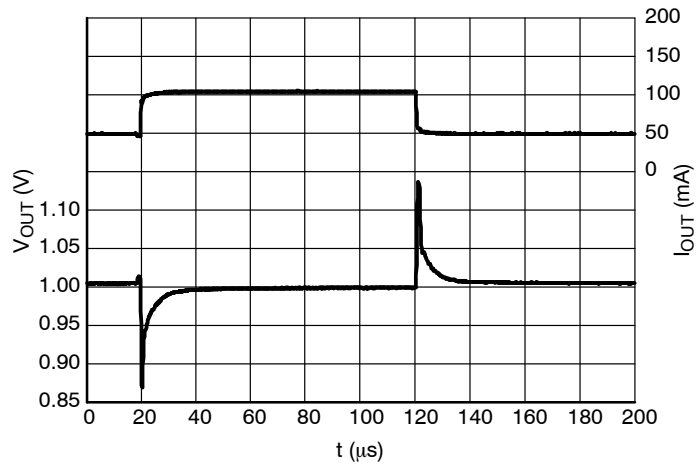

Figure 33. Load Transients, 1.0 V Version,  
 $t_R = t_F = 0.5 \mu$ s,  $V_{IN} = 2.0$  V

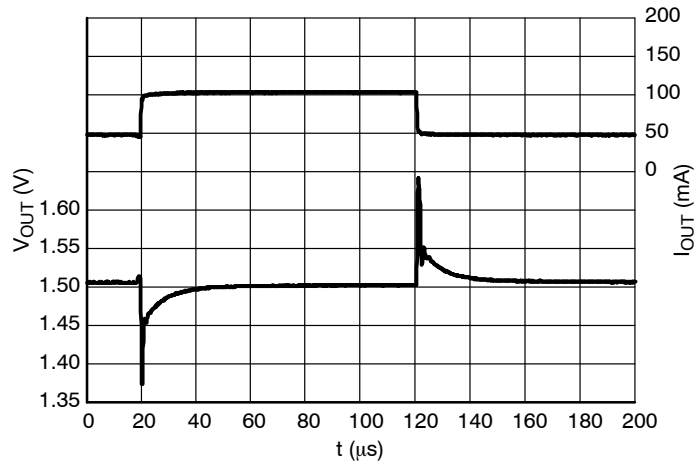

Figure 34 - Load Transients, 1.5 V Version,  
 $t_R = t_F = 0.5 \mu$ s,  $V_{IN} = 1.5$  V

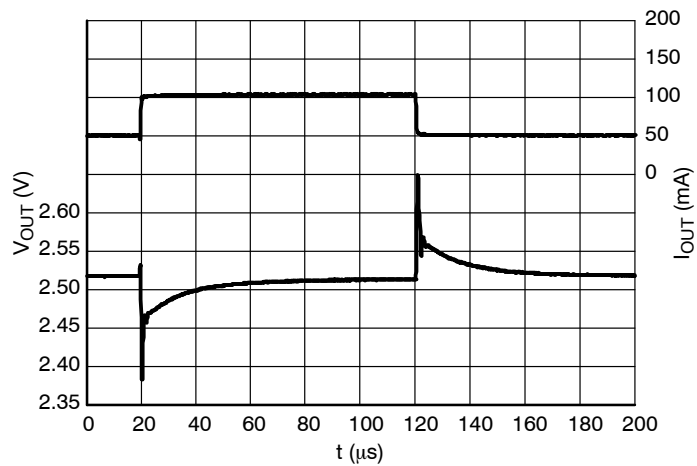
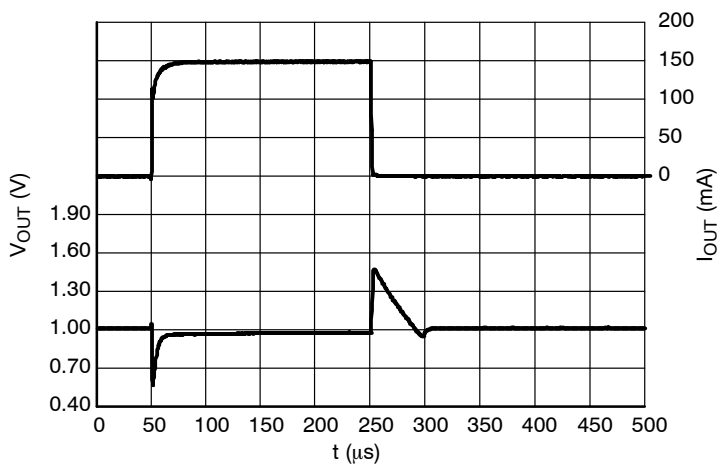

Figure 35. Load Transients, 2.5 V Version,  
 $t_R = t_F = 0.5 \mu$ s,  $V_{IN} = 3.5$  V

# NCP4588

## TYPICAL CHARACTERISTICS



**Figure 36. Load Transients, 1.0 V Version,  
 $t_R = t_F = 0.5 \mu\text{s}$ ,  $V_{IN} = 2.0 \text{ V}$**

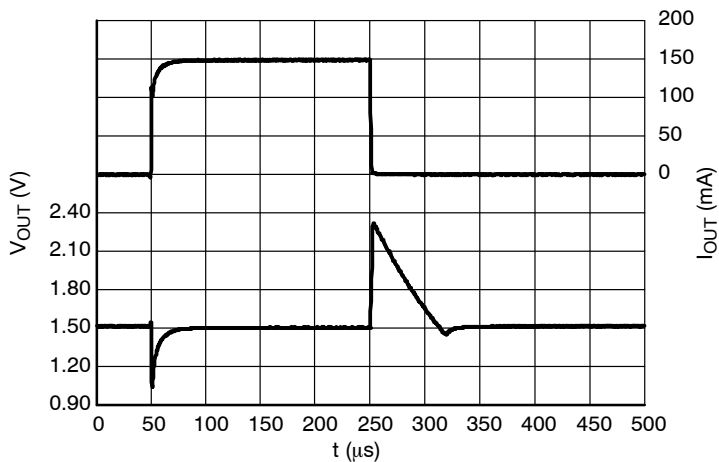

**Figure 37. Load Transients, 1.5 V Version,  
 $t_R = t_F = 0.5 \mu\text{s}$ ,  $V_{IN} = 2.5 \text{ V}$**

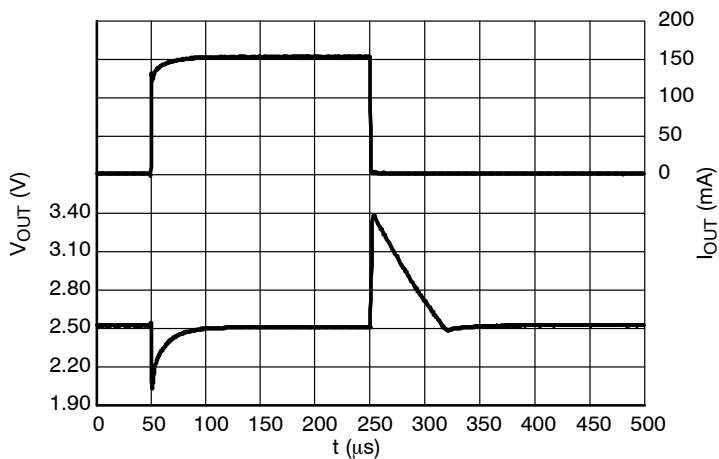

**Figure 38. Load Transients, 2.5 V Version,  
 $t_R = t_F = 0.5 \mu\text{s}$ ,  $V_{IN} = 3.5 \text{ V}$**

# NCP4588

## TYPICAL CHARACTERISTICS

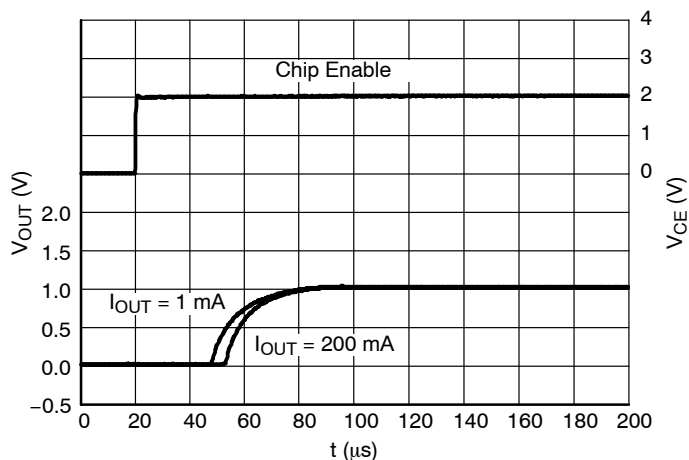

Figure 39. Start-up, 1.0 V Version,  $V_{IN} = 2.0 \text{ V}$

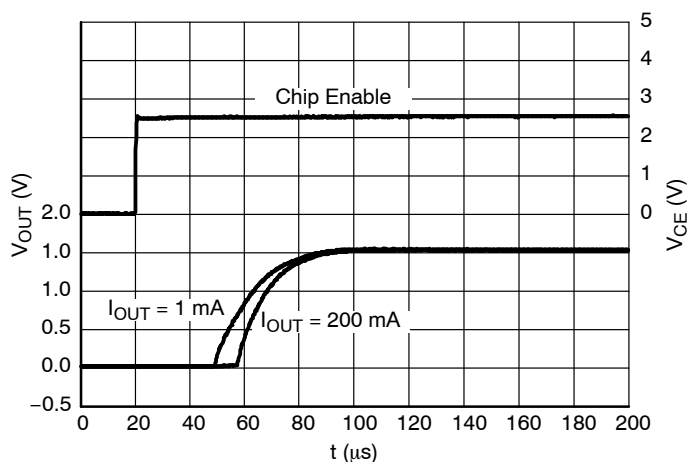

Figure 40. Start-up, 1.5 V Version,  $V_{IN} = 2.5 \text{ V}$

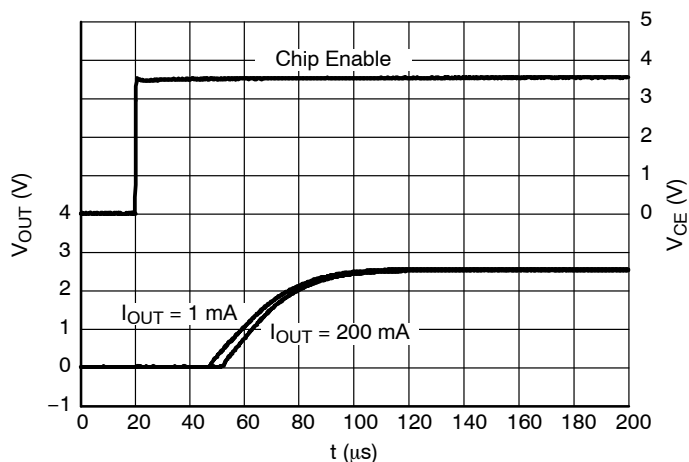

Figure 41. Start-up, 2.5 V Version,  $V_{IN} = 3.5 \text{ V}$

# NCP4588

## TYPICAL CHARACTERISTICS

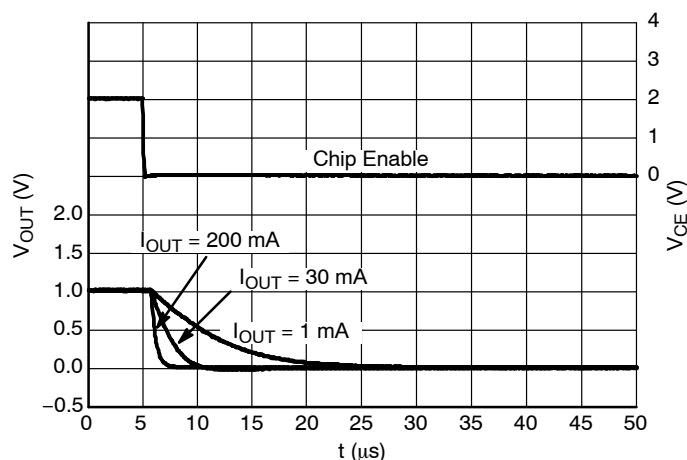

Figure 42. Shutdown, 1.0 V Version D,  
 $V_{IN} = 2.0$  V

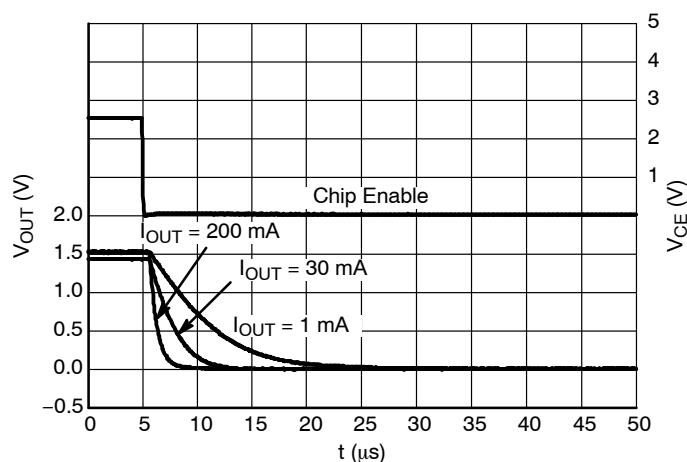

Figure 43. Shutdown, 1.5 V Version D,  
 $V_{IN} = 2.5$  V

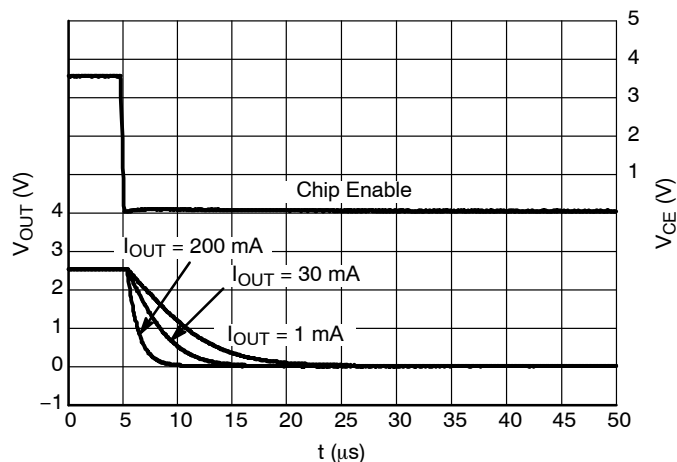

Figure 44. Shutdown, 2.5 V Version D,  
 $V_{IN} = 3.5$  V

APPLICATION INFORMATION

A typical application circuit for NCP4588 series is shown in Figure 45.

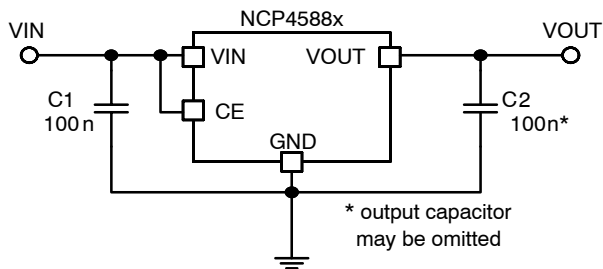

Figure 45. Typical Application Schematic

Input Decoupling Capacitor (C1)

A 100 nF ceramic input decoupling capacitor should be connected as close as possible to the input and ground pin of the NCP4588. Higher values and lower ESR improves line transient response.

Output Decoupling Capacitor (C2)

The output capacitor may be not used even if the load current is varied, but if load variation is very large it is better to use an output capacitor in the range of 0.1  $\mu$ F to 10  $\mu$ F. It is recommended to use ceramic capacitor; tantalum capacitor with higher ESR may cause unstable output.

Enable Operation

The enable pin CE may be used for turning the regulator on and off. The regulator is switched on when the CE pin

voltage is above logic high level. The enable pin has internal pull down current source. If enable function is not needed connect CE pin to VIN.

Output Discharger

The D version includes a transistor between VOUT and GND that is used for faster discharging of the output capacitor. This function is activated when the IC goes into disable mode.

Thermal

As power across the IC increases, it might become necessary to provide some thermal relief. The maximum power dissipation supported by the device is dependent upon board design and layout. Mounting pad configuration on the PCB, the board material, and also the ambient temperature affect the rate of temperature rise for the part. That is to say, when the device has good thermal conductivity through the PCB, the junction temperature will be relatively low with high power dissipation applications.

PCB layout

Make VIN and GND line sufficient. If their impedance is high, noise pickup or unstable operation may result. Connect capacitors C1 and C2 (if it is used) as close as possible to the IC, and make wiring as short as possible.

ORDERING INFORMATION

Device	Nominal Output Voltage	Description	Marking	Package	Shipping†
NCP4588DSQ10T1G	1.0 V	Auto discharge	P010	SC-70 (Pb-Free)	3000 / Tape & Reel
NCP4588DSQ15T1G	1.5 V	Auto discharge	P015	SC-70 (Pb-Free)	3000 / Tape & Reel
NCP4588DSQ25T1G	2.5 V	Auto discharge	P025	SC-70 (Pb-Free)	3000 / Tape & Reel
NCP4588DMX10TCG	1.0 V	Auto discharge	LA	XDFN (Pb-Free)	5000 / Tape & Reel
NCP4588DMX15TCG	1.5 V	Auto discharge	LF	XDFN (Pb-Free)	5000 / Tape & Reel
NCP4588DMX25TCG	2.5 V	Auto discharge	LR	XDFN (Pb-Free)	5000 / Tape & Reel

†For information on tape and reel specifications, including part orientation and tape sizes, please refer to our Tape and Reel Packaging Specifications Brochure, BRD8011/D.

NOTE: To order other package and voltage variants, please contact your ON Semiconductor sales representative.

# NCP4588

## PACKAGE DIMENSIONS

SC-88A (SC-70-5/SOT-353)  
CASE 419A-02  
ISSUE L

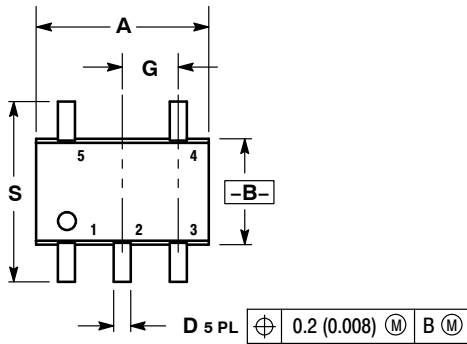

NOTES:

1. DIMENSIONING AND TOLERANCING PER ANSI Y14.5M, 1982.
2. CONTROLLING DIMENSION: INCH.
3. 419A-01 OBSOLETE. NEW STANDARD 419A-02.
4. DIMENSIONS A AND B DO NOT INCLUDE MOLD FLASH, PROTRUSIONS, OR GATE BURRS.

DIM	INCHES		MILLIMETERS	
	MIN	MAX	MIN	MAX
A	0.071	0.087	1.80	2.20
B	0.045	0.053	1.15	1.35
C	0.031	0.043	0.80	1.10
D	0.004	0.012	0.10	0.30
G	0.026 BSC		0.65 BSC	
H	---	0.004	---	0.10
J	0.004	0.010	0.10	0.25
K	0.004	0.012	0.10	0.30
N	0.008 REF		0.20 REF	
S	0.079	0.087	2.00	2.20

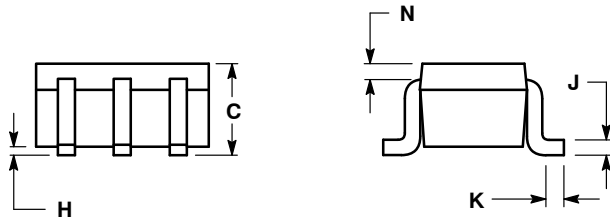

## SOLDER FOOTPRINT

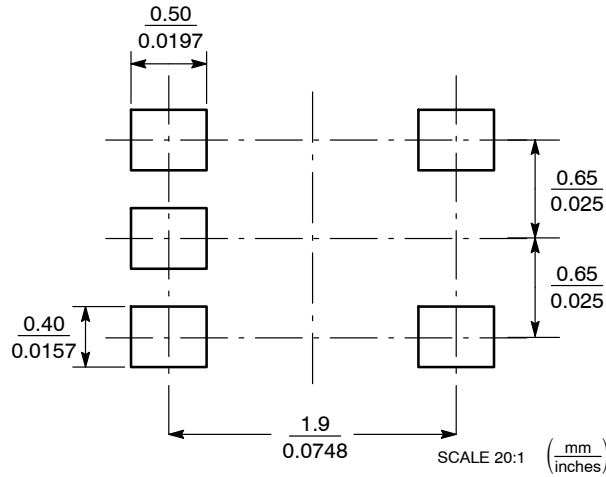

# NCP4588

## PACKAGE DIMENSIONS

### XDFN6 1.2x1.2, 0.4P CASE 711AA ISSUE O

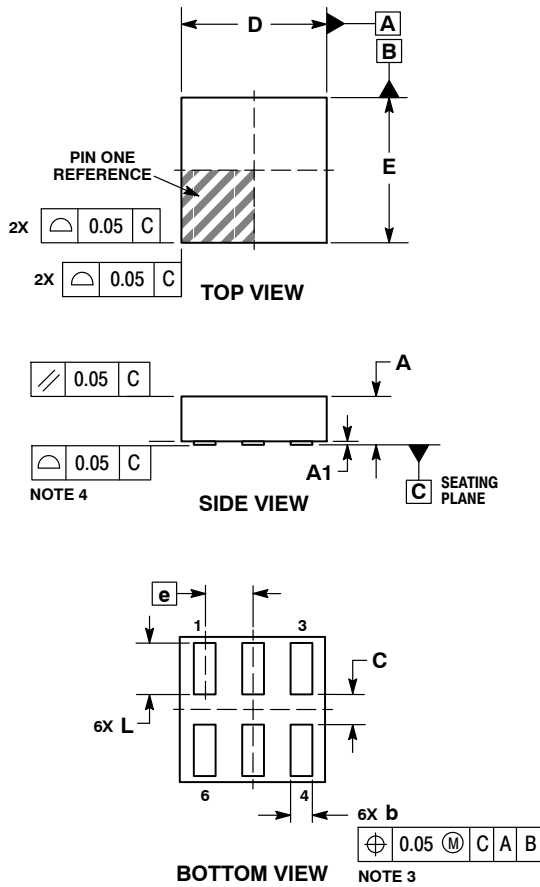

- NOTES:
1. DIMENSIONING AND TOLERANCING PER ASME Y14.5M, 1994.
  2. CONTROLLING DIMENSION: MILLIMETERS.
  3. DIMENSION b APPLIES TO PLATED TERMINAL AND IS MEASURED BETWEEN 0.15 AND 0.25mm FROM TERMINAL TIPS.
  4. COPLANARITY APPLIES TO ALL OF THE TERMINALS.

DIM	MILLIMETERS	
	MIN	MAX
A	---	0.40
A1	0.00	0.05
b	0.13	0.23
C	0.20	0.30
D	1.20 BSC	
E	1.20 BSC	
e	0.40 BSC	
L	0.37	0.48

### RECOMMENDED MOUNTING FOOTPRINT\*

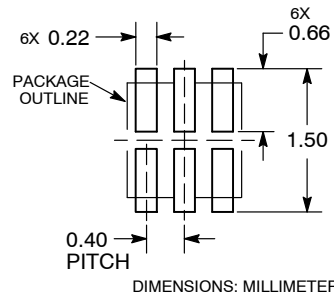

\*For additional information on our Pb-Free strategy and soldering details, please download the ON Semiconductor Soldering and Mounting Techniques Reference Manual, SOLDERRM/D.



# NCP4588

## PACKAGE DIMENSIONS

### SOT-23 5-LEAD CASE 1212 ISSUE A

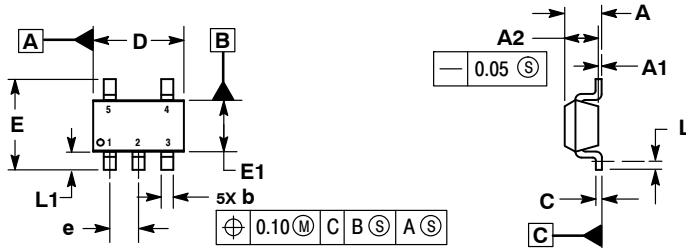

NOTES:

1. DIMENSIONING AND TOLERANCING PER ASME Y14.5M, 1994.
2. CONTROLLING DIMENSIONS: MILLIMETERS.
3. DATUM C IS THE SEATING PLANE.

MILLIMETERS		
DIM	MIN	MAX
A	---	1.45
A1	0.00	0.10
A2	1.00	1.30
b	0.30	0.50
c	0.10	0.25
D	2.70	3.10
E	2.50	3.10
E1	1.50	1.80
e	0.95 BSC	
L	0.20	---
L1	0.45	0.75

### RECOMMENDED SOLDERING FOOTPRINT\*

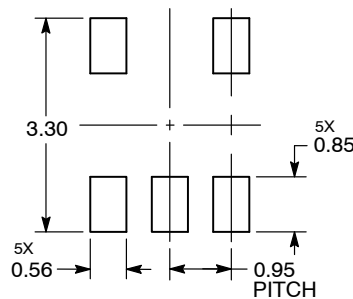

DIMENSIONS: MILLIMETERS

\*For additional information on our Pb-Free strategy and soldering details, please download the ON Semiconductor Soldering and Mounting Techniques Reference Manual, SOLDERRM/D.

ON Semiconductor and are registered trademarks of Semiconductor Components Industries, LLC (SCILLC). SCILLC owns the rights to a number of patents, trademarks, copyrights, trade secrets, and other intellectual property. A listing of SCILLC's product/patent coverage may be accessed at [www.onsemi.com/site/pdf/Patent-Marking.pdf](http://www.onsemi.com/site/pdf/Patent-Marking.pdf). SCILLC reserves the right to make changes without further notice to any products herein. SCILLC makes no warranty, representation or guarantee regarding the suitability of its products for any particular purpose, nor does SCILLC assume any liability arising out of the application or use of any product or circuit, and specifically disclaims any and all liability, including without limitation special, consequential or incidental damages. "Typical" parameters which may be provided in SCILLC data sheets and/or specifications can and do vary in different applications and actual performance may vary over time. All operating parameters, including "Typicals" must be validated for each customer application by customer's technical experts. SCILLC does not convey any license under its patent rights nor the rights of others. SCILLC products are not designed, intended, or authorized for use as components in systems intended for surgical implant into the body, or other applications intended to support or sustain life, or for any other application in which the failure of the SCILLC product could create a situation where personal injury or death may occur. Should Buyer purchase or use SCILLC products for any such unintended or unauthorized application, Buyer shall indemnify and hold SCILLC and its officers, employees, subsidiaries, affiliates, and distributors harmless against all claims, costs, damages, and expenses, and reasonable attorney fees arising out of, directly or indirectly, any claim of personal injury or death associated with such unintended or unauthorized use, even if such claim alleges that SCILLC was negligent regarding the design or manufacture of the part. SCILLC is an Equal Opportunity/Affirmative Action Employer. This literature is subject to all applicable copyright laws and is not for resale in any manner.

### PUBLICATION ORDERING INFORMATION

**LITERATURE FULFILLMENT:**

Literature Distribution Center for ON Semiconductor  
P.O. Box 5163, Denver, Colorado 80217 USA  
Phone: 303-675-2175 or 800-344-3860 Toll Free USA/Canada  
Fax: 303-675-2176 or 800-344-3867 Toll Free USA/Canada  
Email: [orderlit@onsemi.com](mailto:orderlit@onsemi.com)

**N. American Technical Support:** 800-282-9855 Toll Free  
USA/Canada  
**Europe, Middle East and Africa Technical Support:**  
Phone: 421 33 790 2910  
**Japan Customer Focus Center**  
Phone: 81-3-5817-1050

**ON Semiconductor Website:** [www.onsemi.com](http://www.onsemi.com)

**Order Literature:** <http://www.onsemi.com/orderlit>

For additional information, please contact your local Sales Representative