

Dual CoolMOS™ 1) Power MOSFET

Common Source Topology
DCB isoated package

$$V_{DSS} = 600 \text{ V}$$

$$I_{D25} = 47 \text{ A}$$

$$R_{DS(on) \max} = 45 \text{ m}\Omega_{\text{MOSFET}}$$

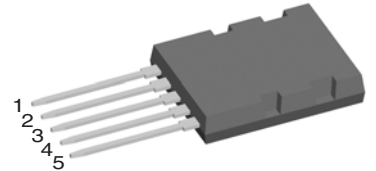
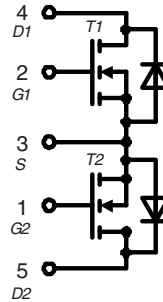

MOSFET T1/T2

Symbol	Conditions	Maximum Ratings
V_{DSS}	$T_{VJ} = 25^\circ\text{C}$	600 V
V_{D1D2}	$T_{VJ} = 25^\circ\text{C}$	± 600 V
V_{GS}		± 20 V
I_{D25}	$T_C = 25^\circ\text{C}$	47 A
I_{D90}	$T_C = 90^\circ\text{C}$	32 A
E_{AS}	single pulse } $I_D = 11 \text{ A}; T_C = 25^\circ\text{C}$ repetitive }	1950 mJ
E_{AR}		3 mJ

Features

- fast CoolMOS™ 1) power MOSFET 4th generation
 - High blocking capability
 - Lowest resistance
 - Avalanche rated for unclamped inductive switching (UIS)
 - Low thermal resistance due to reduced chip thickness
- Enhanced total power density

Applications

- AC Switch
 - power regulation of AC heating
 - light dimming
- Power factor correction (PFC) interleaved operation mode
- Push pull converter

Symbol	Conditions	Characteristic Values ($T_{VJ} = 25^\circ\text{C}$, unless otherwise specified)			
		min.	typ.	max.	
R_{DSon}	$V_{GS} = 10 \text{ V}; I_D = 44 \text{ A}$		40	45 m Ω	
R_{DSon}	total between D1 and D2 $V_{G1S} = V_{G2S} = 10 \text{ V}; I_D = 44 \text{ A}$		80	m Ω	
V_{GSth}	$V_{DS} = V_{GS}; I_D = 3 \text{ mA}$	2.5	3	3.5 V	
I_{DSS}	$V_{DS} = V_{DSS}; V_{GS} = 0 \text{ V}; T_{VJ} = 25^\circ\text{C}$ $T_{VJ} = 125^\circ\text{C}$		50	10 μA μA	
I_{GSS}	$V_{GS} = \pm 20 \text{ V}; V_{DS} = 0 \text{ V}$			100 nA	
C_{iss} C_{oss}	} $V_{GS} = 0 \text{ V}; V_{DS} = 100 \text{ V}$ } $f = 1 \text{ MHz}$		6800	pF	
				320	pF
Q_g Q_{gs} Q_{gd}	} $V_{GS} = 0 \text{ to } 10 \text{ V}; V_{DS} = 400 \text{ V}; I_D = 44 \text{ A}$		150	190 nC	
				35	nC
				50	nC
$t_{d(on)}$ t_r $t_{d(off)}$ t_f	} $V_{GS} = 10 \text{ V}; V_{DS} = 400 \text{ V};$ } $I_D = 44 \text{ A}; R_G = 3.3 \Omega$		30	ns	
				20	ns
				100	ns
				10	ns
R_{thJC} R_{thCH}	with heatsink compound			0.45 K/W	
			0.25		K/W

¹⁾ CoolMOS™ is a trademark of Infineon Technologies AG.

Source-Drain Diode
Characteristic Values

 ($T_J = 25^\circ\text{C}$, unless otherwise specified)

		min.	typ.	max.	
I_S	$V_{GS} = 0\text{ V}$			44	A
V_{SD}	$I_F = 44\text{ A}; V_{GS} = 0\text{ V}$		0.9	1.2	V
t_{rr} Q_{RM} I_{RM}	} $I_F = 44\text{ A}; -di/dt = 100\text{ A}/\mu\text{s}; V_R = 400\text{ V}$		600		ns
			17		μC
			60		A

Component

Symbol	Conditions	Maximum Ratings	
T_{VJ}		-55...+150	$^\circ\text{C}$
T_{stg}		-55...+150	$^\circ\text{C}$
V_{ISOL}	$I_{ISOL} \leq 1\text{ mA}; 50/60\text{ Hz}; t = 1\text{ min}$	2500	V~
F_c	Mounting force with clip	40 - 180	N

Symbol	Conditions	Characteristic Values		
		min.	typ.	max.
C_p	coupling capacity between shorted pins and mounting tab in the case		50	pF
d_S, d_A	pin - pin	tbd		mm
d_S, d_A	pin - backside metal	tbd		mm
Weight			10	g

ISOPLUS264

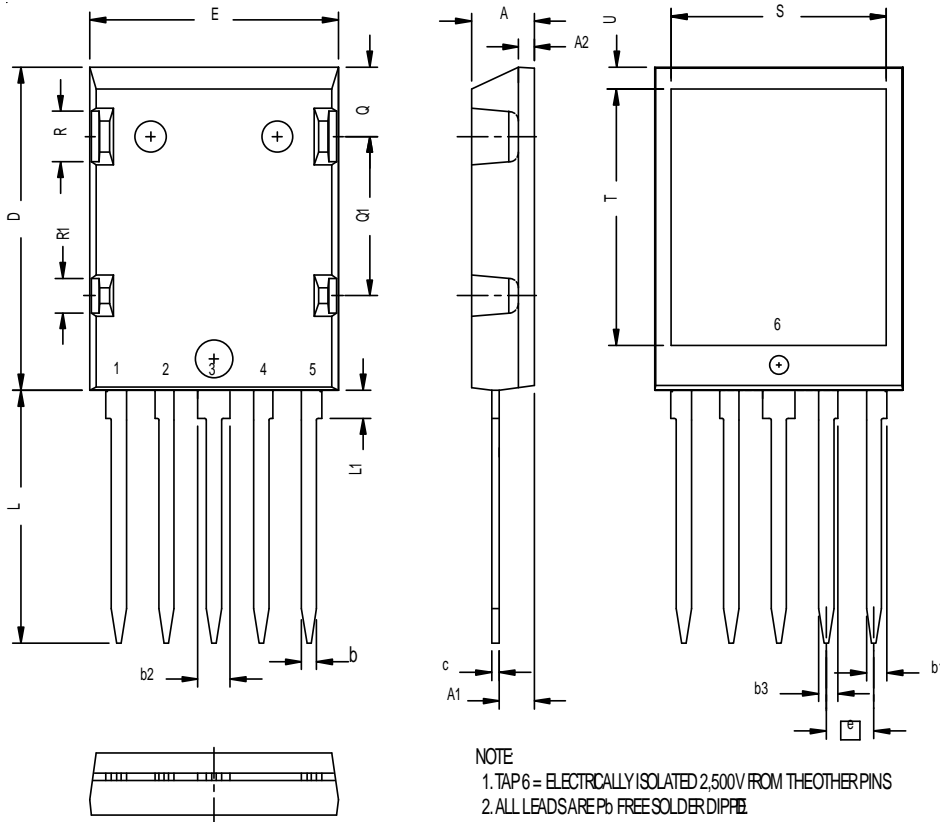

SYM	INCHES		MILLIMETERS	
	MIN	MAX	MIN	MAX
A	.190	.205	4.83	5.21
A1	.102	.118	2.59	3.00
A2	.046	.055	1.17	1.40
b	.045	.055	1.14	1.40
b1	.063	.072	1.60	1.83
b2	.100	.110	2.54	2.78
b3	.058	.068	1.47	1.73
c	.020	.029	0.51	0.74
D	1.020	1.040	25.91	26.42
E	.770	.790	19.56	20.29
e	.150 BSC		3.81 BSC	
L	.780	.820	19.81	20.83
L1	.080	.102	2.03	2.59
Q	.210	.235	5.33	5.97
Q1	.490	.513	12.46	13.03
R	.150	.180	3.81	4.57
R1	.100	.130	2.54	3.30
S	.888	.890	16.97	17.53
T	.801	.821	20.34	20.85
U	.065	.080	1.65	2.03

All curves for single MOSFET T1 or T2 only

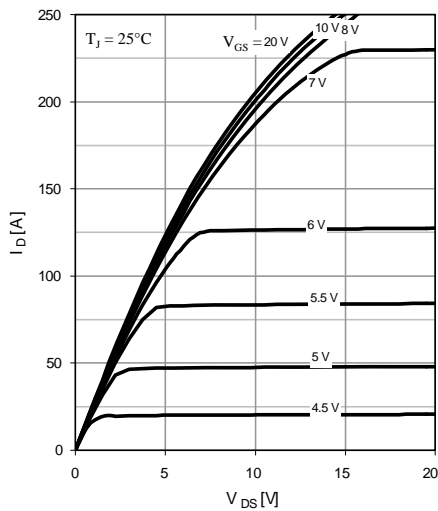

Fig. 1 Typ. output characteristics

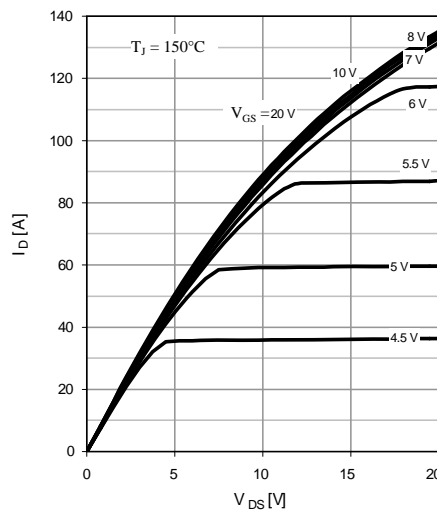

Fig. 2 Typ. output characteristics

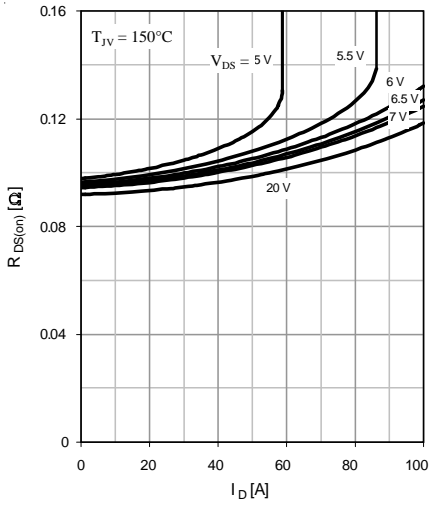

Fig. 3 Typ. drain-source on-state resistance

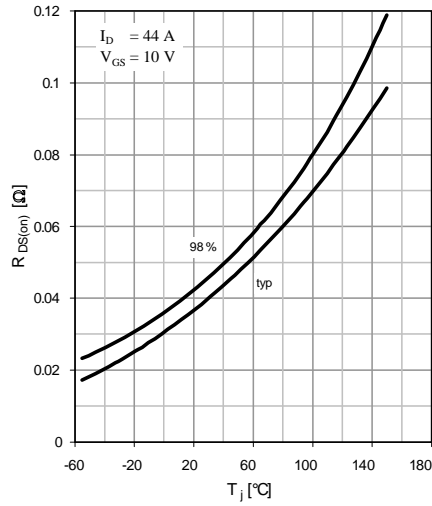

Fig. 4 Drain-source on-state resistance

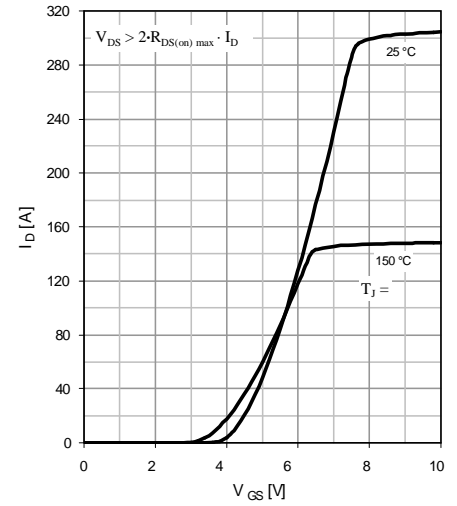

Fig. 5 Typ. transfer characteristics

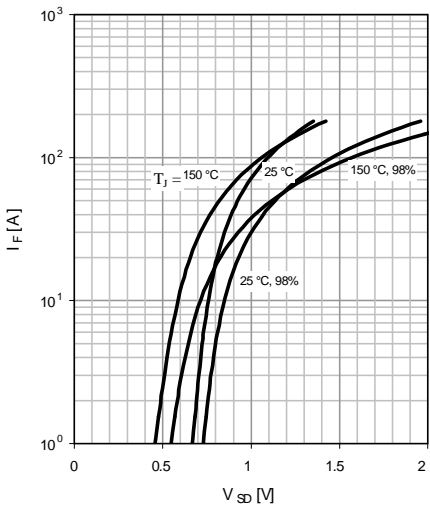

Fig. 6 Forward characteristic of reverse diode

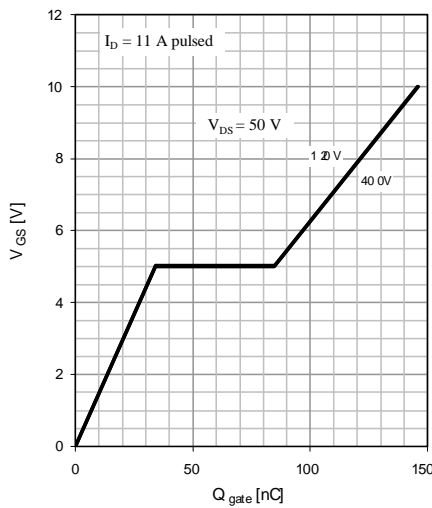

Fig. 7 Typ. gate charge

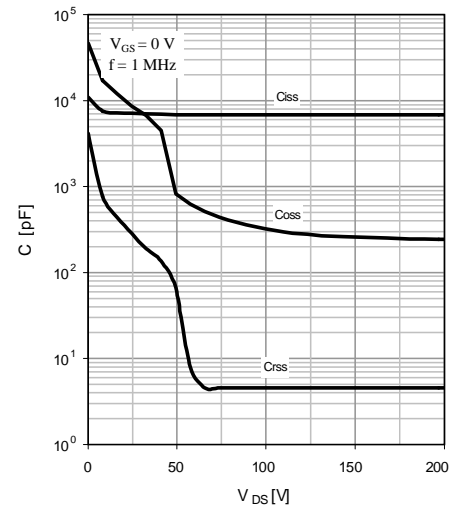

Fig. 8 Typ. capacitances

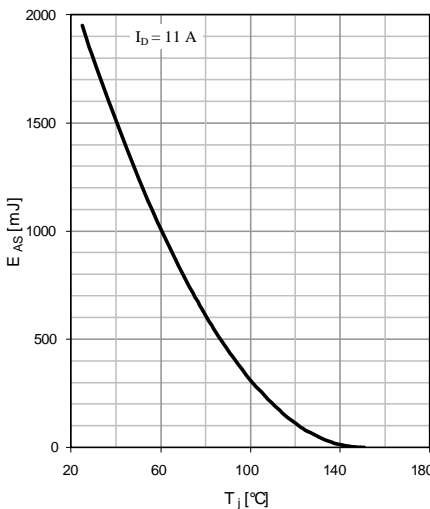

Fig. 9 Avalanche energy

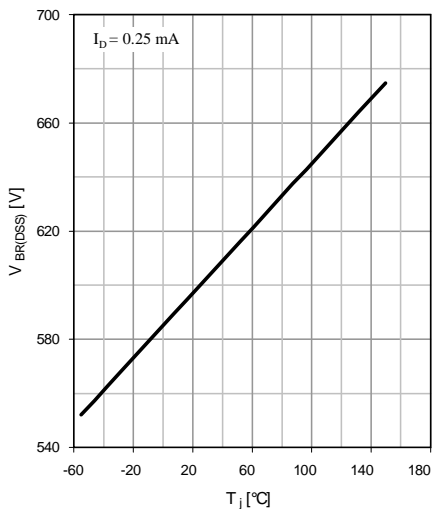

Fig. 10 Drain-source break-down voltage