

RoHS Compliant

**Features**

- Distributed constant type LC filter. Prevents ringing caused by circuit impedance. Suitable for high speed digital circuits and video signal lines.
- Stable noise attenuation over wide frequency ranges.
- Low profile (T=0.95mm max.) suitable for miniature electronic equipments.
- First class auto-placement

**Applications**

- PCs, Laser Printers, Cellular Phone, Clock Data Lines for LCD Display
- High Speed Video Signal Circuits and Interface Circuits
- High Speed Digital Circuits
- Anti-Noise Solution  
Achieves Effective Noise Suppression in Noisy High Speed Circuits without Signal Waveform Distortion

**How to Order**

**KNF 21 050 - W 3**  
① ② ③ ④ ⑤

- ① Series
- ② Size EIA (EIAJ)  
21 :0805 (2012)
- ③ Frequency

<b>025</b>	25MHz	<b>200</b>	200MHz
<b>050</b>	50MHz	<b>400</b>	400MHz
<b>100</b>	100MHz		

- ④ Taping Direction (See Fig 1)  
W: Standard
- ⑤ Quantity per Reel

<b>3</b>	3000pcs.
----------	----------

**Dimensions**

(Unit : mm)

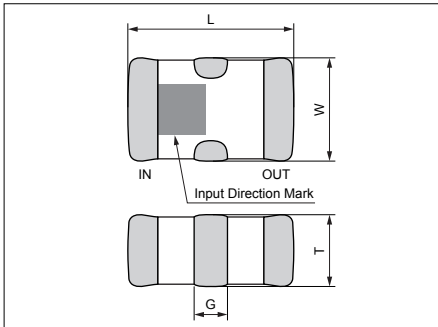

KNF21	
<b>L</b>	2.0±0.2
<b>W</b>	1.25±0.2
<b>T</b>	0.8±0.15
<b>G</b>	0.4±0.3

**Specifications**

Part Number	Cut off Freq. (MHz)	Capacitance (+50/-20%) (pF)	20dB Attenuation (Typical)	Rated current(mA)	Rated voltage(VDC)
<b>KNF21025</b>	25MHz	235pF	200- 600MHz	150mA	25VDC
<b>KNF21050</b>	50MHz	130pF	350- 850MHz		
<b>KNF21100</b>	100MHz	65pF	450- 950MHz		
<b>KNF21200</b>	200MHz	33pF	700-1200MHz		
<b>KNF21400</b>	400MHz	17pF	900-1400MHz		

\*Cut off Frequency at Attenuation typical 3dB, max. 6dB  
Operating Temperature: -25 to 85(°C)

**Frequency Characteristics**

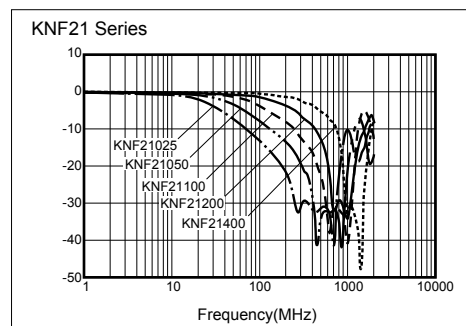
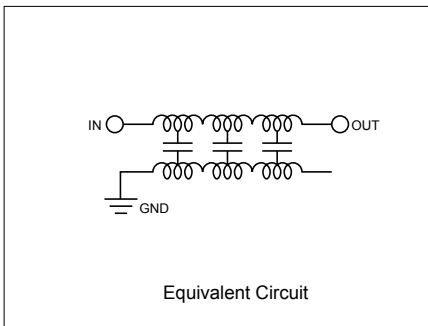

**<Impedance Matching Free>**

- Stable attenuation against impedance change
- Good impedance matching without ringing on distortion even at the time of IC ON/OFF and pattern layout change

**Test circuit**

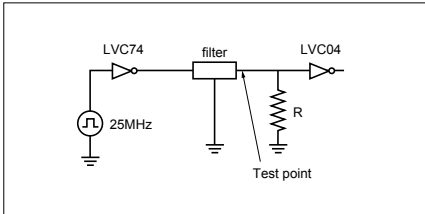

**Output Waveform (Clock frequency 25MHz)**

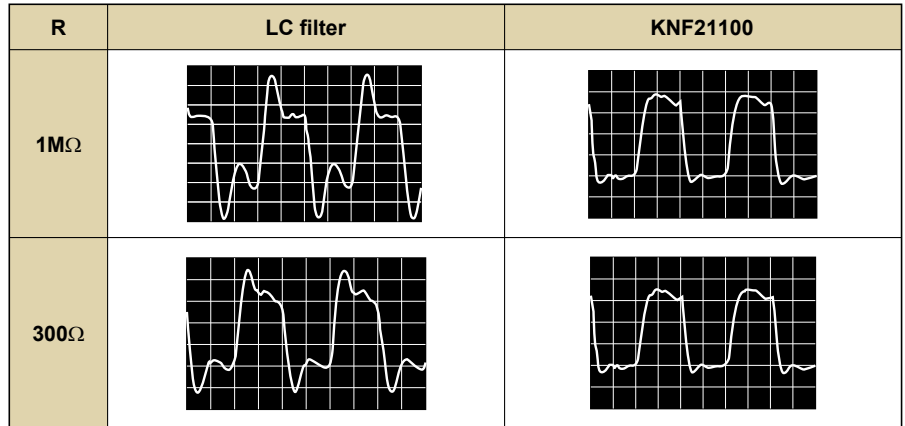

**<No Ringing>**

**Excellent Impedance Matching**

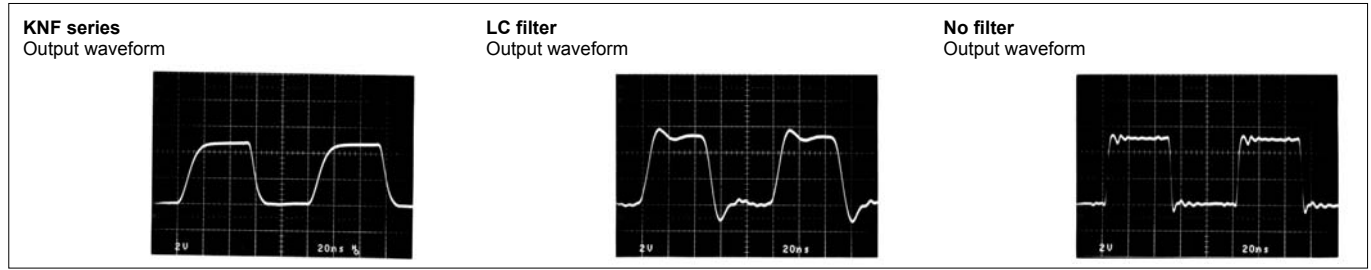

- Wide attenuation up to high frequency range without distortion

**Wide Attenuation Bandwidth**

**Test Circuit**

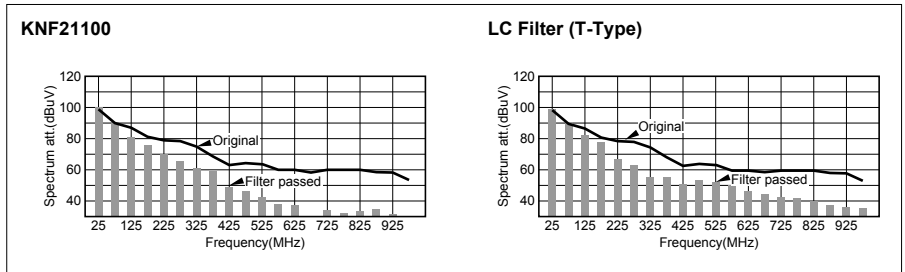
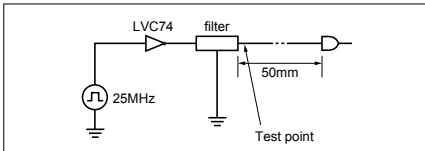

**Recommended Land Pattern**

(Unit : mm)

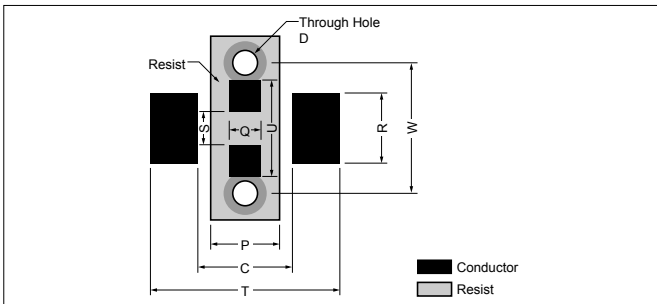

	T	W	R	C	P	Q	S	D	U
KNF21	3.20	2.30	1.00	1.20	0.80	0.40	0.60	0.3-0.4	2.00

**Packaging Specification (Fig.1)**

- Taping (3,000/reel)

(Unit : mm)

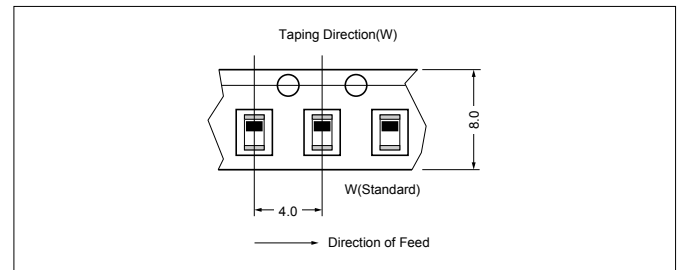

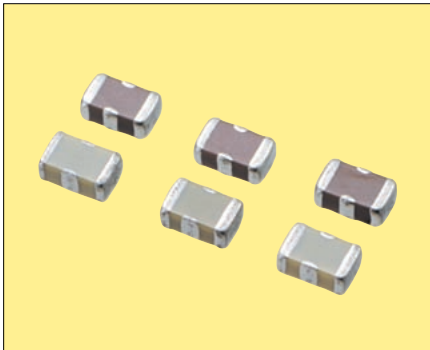

**Pb Free**

**RoHS Compliant**

**Features**

- 0805 Size. Rated current up to 2A.
- Effective for filtering noise on power (Vcc) lines.

**Applications**

- PCs, Laser Printers, Cellular Phone, Power/Signal Lines for LCD Display, Office Equipments
- AV Power Supply/Signal Line, TV, VCR, etc.
- High Current Signal Lines

**How to Order**

KNH 21 104 - 3 AA  
① ② ③ ④ ⑤

- ① Series
- ② Size EIA (EIAJ)  
21: 0805 (2012)
- ③ Capacitance Value

<b>104</b>	100nF	<b>101</b>	100pF
<b>473</b>	47nF	<b>470</b>	47pF
<b>471</b>	470pF	<b>220</b>	22pF
<b>221</b>	220pF		

- ④ Quantity per Reel

<b>3</b>	3000pcs.
----------	----------

- ⑤ Code (AA : STD)

**Dimensions**

(Unit : mm)

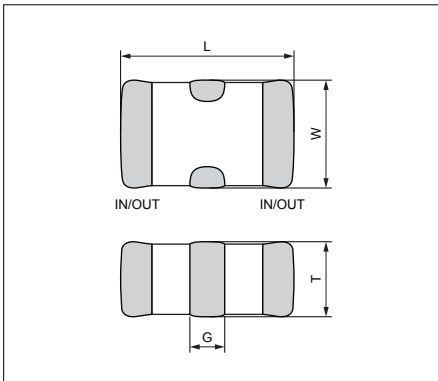

	<b>KNH21</b>
<b>L</b>	2.0±0.2
<b>W</b>	1.25±0.2
<b>T</b>	0.85±0.15
<b>G</b>	0.40±0.30

**Specifications**

Type	Capacitance Value(pF) (+50/-20%)	Rated Current (A)	Rated Voltage (VDC)	Direct-current resistance(Ω)
<b>KNH21104</b>	100,000	2.0	25	≤0.02
<b>KNH21473</b>	47,000	2.0	50	≤0.02
<b>KNH21471</b>	470	1.0	50	≤0.08
<b>KNH21221</b>	220	1.0	50	≤0.08
<b>KNH21101</b>	100	1.0	50	≤0.08
<b>KNH21470</b>	47	1.0	50	≤0.08
<b>KNH21220</b>	22	1.0	50	≤0.08

Operating Temperature: -25 to 85(°C)

**Attenuation Characteristics**

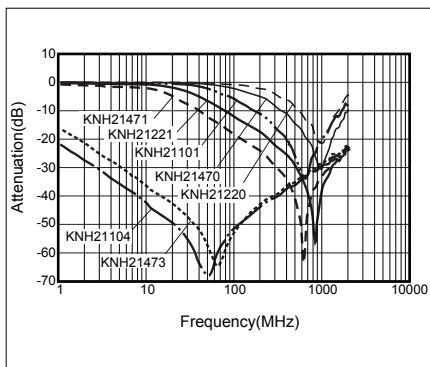

**Recommended Land Pattern** (Unit : mm)

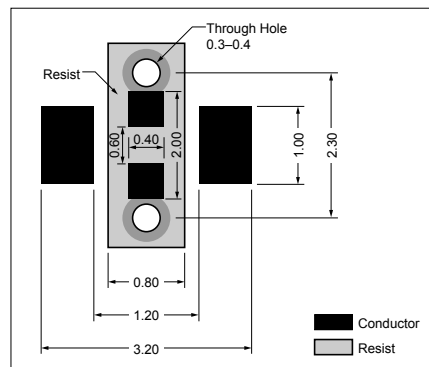

**Packaging specifications**

- Taping (3000/reel)

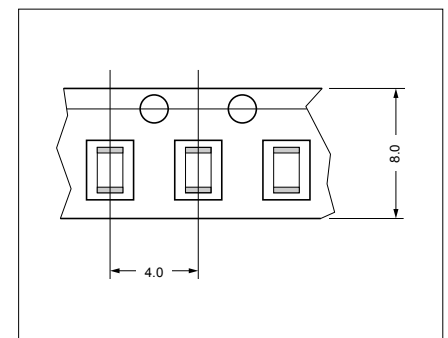

**<Electrical Characteristics>**

- Wide attenuation range including surrounding circuit.

**Test Circuit**

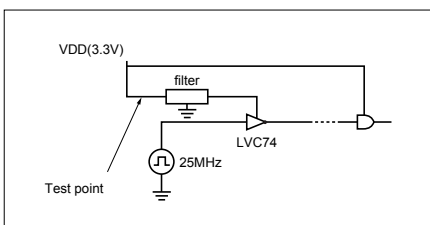

**Attenuation Effect of Power Supply Noise**

