

G series

Slide switches • telecom grade



DISTINCTIVE FEATURES

Panel and PC mount models

6 actuator lengths

Wide variety of contact materials



ELECTRICAL SPECIFICATIONS

- Max. current/voltage rating with resistive load :
 - silver contacts (codes 1 or 2) : 3 A 30 VDC
 - gold plated brass contacts (code 0) : 0.4 VA 20 VAC or DC max.
- Initial contact resistance : 10 mΩ
- Insulation resistance : 1,000 MΩ min.
- Dielectric strength : 1,000 Vrms 50 Hz min.
- Electrical life with resistive load :
 - silver contacts (codes 1 or 2) : 2 positions : 40,000 cycles;
3 positions : 20,000 cycles
 - gold plated brass contacts (code 0) : 60,000 cycles (0,4VA max.)



GENERAL SPECIFICATIONS

- Travel : 2.20 mm (.086), except on model GN3... : 2.60 mm (.102)
- Operating temperature : -30 °C to +85 °C (-22 °F to +185 °F)
- Recommended soldering : 300 °C (572 °F) 5 sec. max.



MATERIALS

- Case : PES
- Actuator : polyamide, glass filled
- Cover : stainless steel
- Contacts
 - 0 : brass, gold plated
 - 1 : silver
 - 2 : silver, gold plated
 - 5 : special contact, lower rating, minimum quantity : consult factory
- Terminal seal : epoxy

APEM products may be recycled at end-of-life for the re-claiming of valuable metal components.

The company reserves the right to change specifications without notice.



G series

Slide switches • telecom grade



PANEL CUT-OUT

SOLDER LUG MODEL

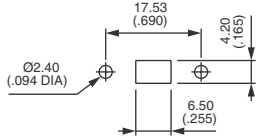

TERMINALS

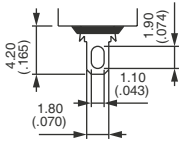

Solder lugs

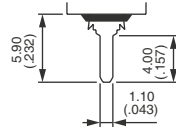

Straight PC



ELECTRICAL FUNCTIONS

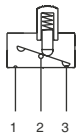

PCB MOUNTING

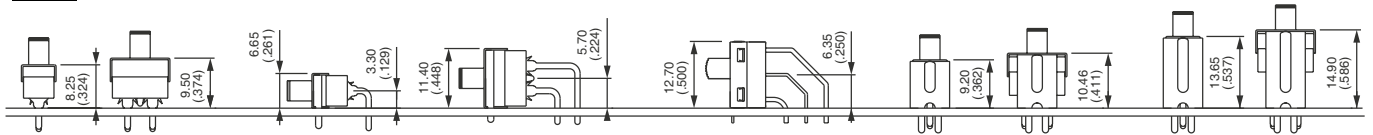



BUILD YOUR PART NUMBER

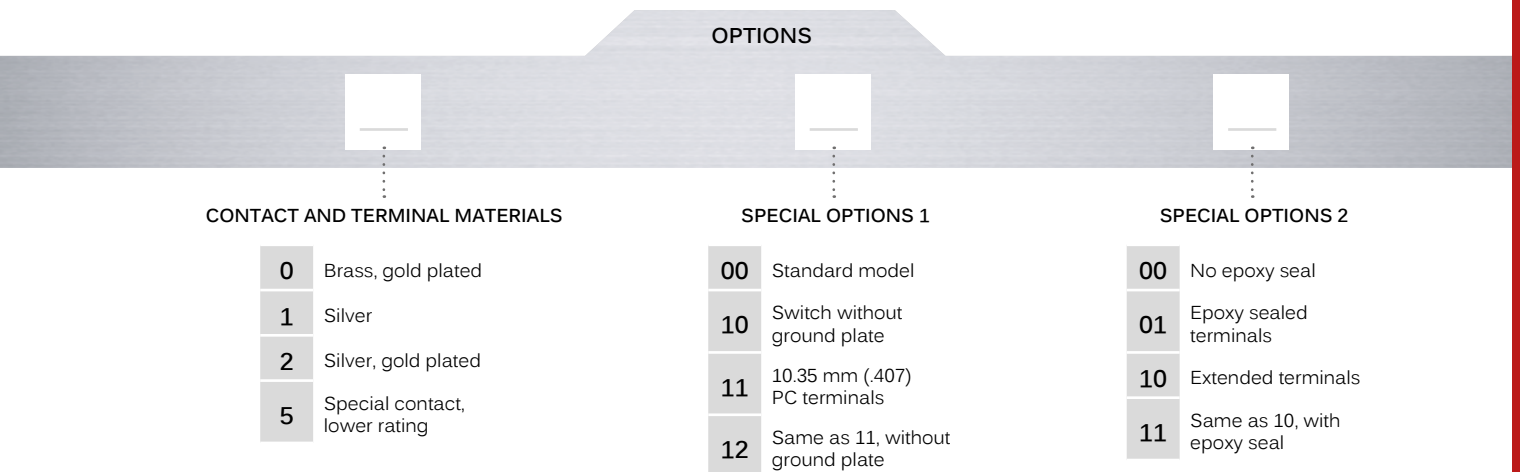
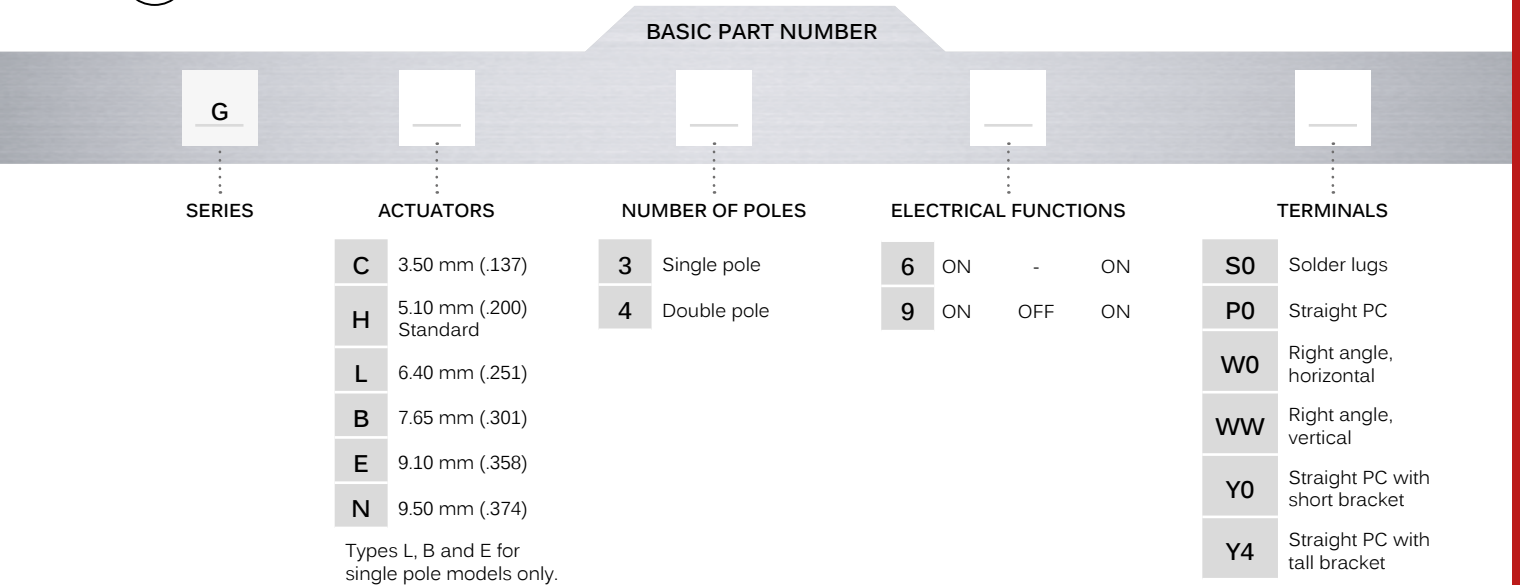

ABOUT THIS SERIES

On the following pages, you will find successively basic part numbers of switches and options in the same order as in above chart.

Notice : please note that not all combinations of above numbers are available. Refer to the following pages for further information.

G series

Slide switches • telecom grade

SOLDER LUG TERMINALS



Single pole	Double pole			
GH36S0	GH46S0	ON	-	ON
GH39S0	GH49S0	ON	OFF	ON

STRAIGHT PC TERMINALS



Single pole	Double pole			
GH36P0	GH46P0	ON	-	ON
GH39P0	GH49P0	ON	OFF	ON

RIGHT ANGLE TERMINALS - HORIZONTAL



Single pole	Double pole			
GH36W0	GH46W0	ON	-	ON
GH39W0	GH49W0	ON	OFF	ON

RIGHT ANGLE TERMINALS - VERTICAL



Single pole	Double pole			
GH36WW	GH46WW	ON	-	ON
GH39WW	GH49WW	ON	OFF	ON

Shown with standard actuator (type H)

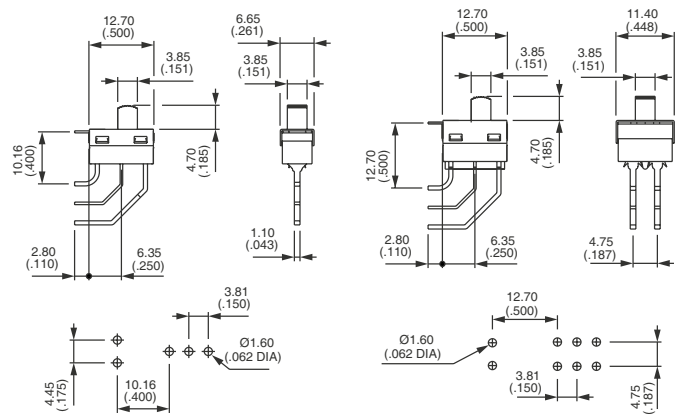
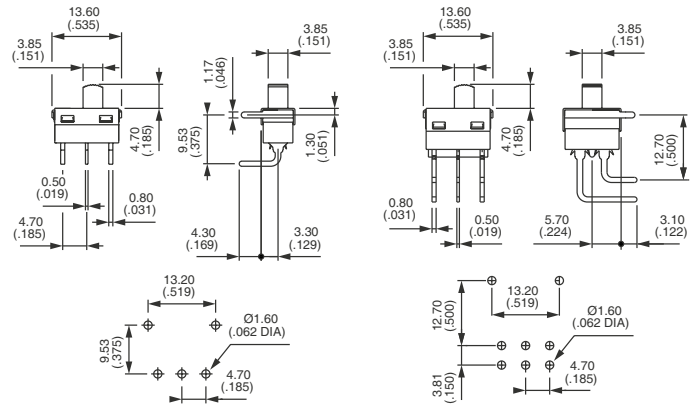
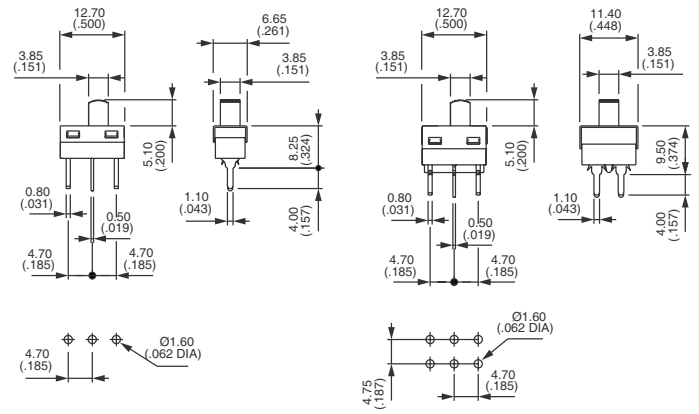
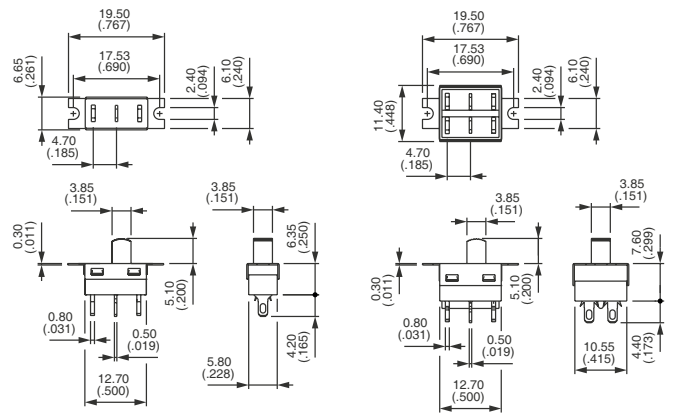

STRAIGHT PC TERMINALS SHORT BRACKET : Y0



Single pole	Double pole			
GH36Y0	GH46Y0	ON	-	ON
GH39Y0	GH49Y0	ON	OFF	ON

STRAIGHT PC TERMINALS TALL BRACKET : Y4



Single pole	Double pole			
GH36Y4	GH46Y4	ON	-	ON
GH39Y4	GH49Y4	ON	OFF	ON

Shown with standard actuator (type H)

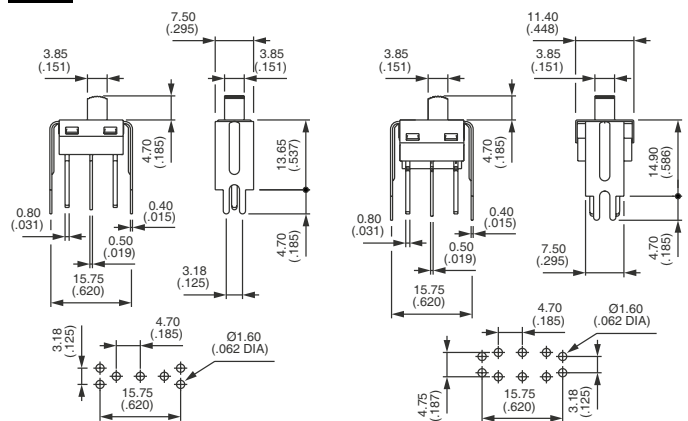
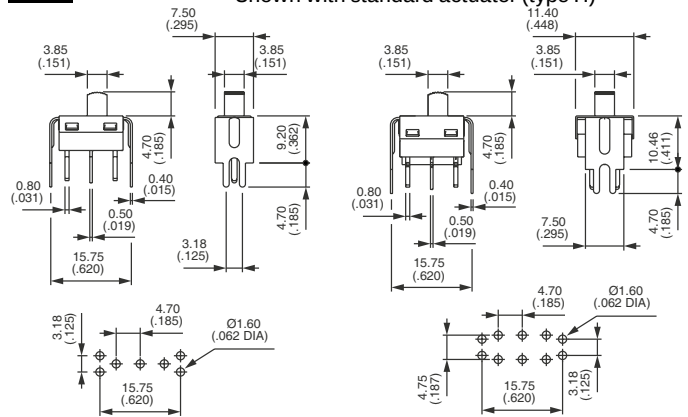

ACTUATORS

For a different actuator, replace second digit (H) of basic part number with one of the following codes.

- ⓘ Dimensions below are for solder lug (S0) and straight terminals (P0) models.
For other models (WO - WW - Y0 - Y4), height is less 0.4 mm (.015).

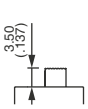

C

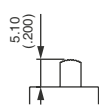

H

Standard

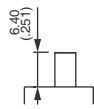

L *

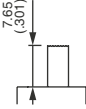

B *

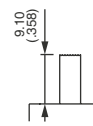

E *

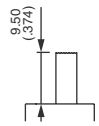

N

* For single pole only

G series

Slide switches • telecom grade

CONTACT AND TERMINAL MATERIALS



- 0 Brass, gold plated
- 1 Silver
- 2 Silver, gold plated
- 5 Special contact, lower rating, minimum quantity : consult factory

SPECIAL OPTIONS 1

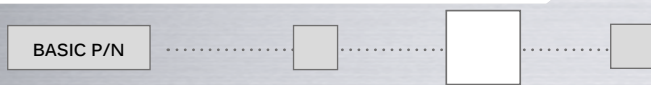

- 00 Standard switch as presented on previous pages
- 10 Switch without ground plate
For right angle only (W0 and WW models)
- 11 10.35 mm (.407) long PC terminals
- 12 10.35 mm (.407) long PC terminals without ground plate

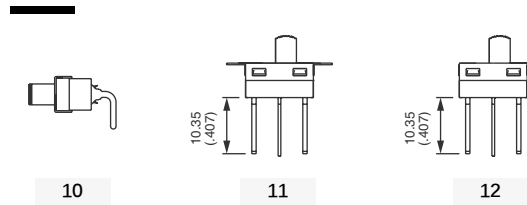

SPECIAL OPTIONS 2

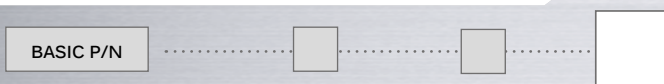

- 00 No epoxy seal
- 10 Epoxy sealed terminals
(compulsory on solder lug models)
- 11 Extended terminals
For vertical right angle (WW models)
- 12 Extended terminals as above, with epoxy seal

