

FLUKE®

787
ProcessMeter

Users Manual

April 1997, Rev.3, 12/01

© 1997, 1898, 2000, 2001 Fluke Corporation, All rights reserved. Printed in U.S.A.
All product names are trademarks of their respective companies.

LIMITED WARRANTY & LIMITATION OF LIABILITY

This Fluke product will be free from defects in material and workmanship for three years from the date of purchase. This warranty does not cover disposable batteries or damage from accident, neglect, misuse or abnormal conditions of operation or handling. Resellers are not authorized to extend any other warranty on Fluke's behalf. To obtain service during the warranty period, send your defective meter to the nearest Fluke Authorized Service Center with a description of the problem.

THIS WARRANTY IS YOUR ONLY REMEDY. NO OTHER WARRANTIES, SUCH AS FITNESS FOR A PARTICULAR PURPOSE, ARE EXPRESSED OR IMPLIED. FLUKE IS NOT LIABLE FOR ANY SPECIAL, INDIRECT, INCIDENTAL OR CONSEQUENTIAL DAMAGES OR LOSSES, ARISING FROM ANY CAUSE OR THEORY.

Since some states or countries do not allow the exclusion or limitation of an implied warranty or of incidental or consequential damages, this limitation of liability may not apply to you.

Fluke Corporation
P.O. Box 9090
Everett, WA
98206-9090 USA

Fluke Europe B.V.
P.O. Box 1186
5602 B.D. Eindhoven
The Netherlands

Table of Contents

Title	Page
Introduction.....	1
Contacting Fluke	1
Safety Information	2
How to Get Started.....	5
Getting Acquainted with the Meter	6
Measuring Electrical Parameters.....	17
Input Impedance.....	17
Ranges	17
Measuring a Composite Signal.....	17
Testing Diodes.....	18
Displaying Minimum, Maximum, and Average.....	18
Using TouchHold	19
Compensating for Test Lead Resistance.....	19
Using the Current Output Functions	20
Source Mode	20

Simulate Mode	22
Changing the Current Span	22
Producing a Steady mA Output.....	24
Manually Stepping the mA Output	25
Auto Ramping the mA Output	26
Power-Up Options.....	27
Battery Life.....	28
Using the Holster and Flex-Stand	28
Maintenance	28
General Maintenance.....	28
Calibration.....	28
Replacing the Battery.....	30
Replacing a Fuse	31
If the Meter does not Work.....	32
Replacement Parts and Accessories	33
Specifications.....	36

Index

ProcessMeter

Introduction

⚠ Warning

Read “Safety Information” before you use the meter.

Your Fluke 787 ProcessMeter™ (referred to as “the meter”) is a handheld, battery-operated tool for measuring electrical parameters and supplying steady or ramping current to test process instruments. It has all the features of a digital multimeter, plus current output capability.

Your meter is shipped with a Flex-Stand™ holster, one set of TL75 test leads, one set of AC70A Alligator Clips, this manual, and a laminated Quick Reference Card that fits inside the holster.

If the meter is damaged or something is missing, contact the place of purchase immediately.

Contact your Fluke distributor for information about DMM accessories. To order replacement parts or spares, see Table 13 near the end of this manual.

Contacting Fluke

To order accessories, receive operating assistance, or get the location of the nearest Fluke distributor or Service Center, call:

USA : 1-888-99-FLUKE (1-888-993-5853)

Canada: 1-800-36-FLUKE (1-800-363-5853)

Europe: +31 402-678-200

Japan: +81-3-3434-0181

Singapore: +65-738-5655

Anywhere in the world: +1-425-446-5500

Address correspondence to:

Fluke Corporation
P.O. Box 9090,
Everett, WA 98206-9090
USA

Fluke Europe B.V.
P.O. Box 1186,
5602 BD Eindhoven
The Netherlands

Or visit us on the World Wide Web: www.fluke.com

Safety Information

The meter complies with IEC1010-1, ANSI/ISA S82.01-1994 and CAN/CSA C22.2 No. 1010.1-92 Overvoltage Category III. Use the meter only as specified in this manual, otherwise the protection provided by the meter may be impaired.

A **Warning** identifies conditions and actions that pose hazard(s) to the user; a **Caution** identifies conditions and actions that may damage the meter or the equipment under test.

International symbols used on the meter and in this manual are explained in Table 1.

Warning

To avoid possible electric shock or personal injury:

- **Do not use the meter if it is damaged. Before you use the meter, inspect the case. Look for cracks or missing plastic. Pay particular attention to the insulation surrounding the connectors.**

- **Make sure the battery door is closed and latched before you operate the meter.**
- **Remove test leads from the meter before you open the battery door.**
- **Inspect the test leads for damaged insulation or exposed metal. Check test leads continuity. Replace damaged test leads before you use the meter.**
- **Do not use the meter if it operates abnormally. Protection may be impaired. When in doubt, have the meter serviced.**
- **Do not operate the meter around explosive gas, vapor, or dust.**
- **Use only a single 9V battery, properly installed in the meter case, to power the meter.**
- **When servicing the meter, use only specified replacement parts.**

Caution

To avoid possible damage to meter or to equipment under test:













Disconnect the power and discharge all high-voltage capacitors before testing resistance or continuity.

Use the proper jacks, function, and range for your measurement or sourcing application.

To protect yourself, adhere to the following guidelines:

- Use caution when working above 30V ac rms, 42V ac pk, or 60V dc. Such voltages pose a shock hazard.
- When using the probes, keep your fingers behind the finger guards on the probes.
- Connect the common test lead before you connect the live test lead. When you disconnect test leads, disconnect the live test lead first.

Table 1. International Symbols

Symbol	Meaning	Symbol	Meaning
	Alternating current		Earth ground
	Direct current		Fuse
	Alternating or direct current		Conforms to European Union directives
	Refer to the manual for information about this feature.		Conforms to relevant Canadian Standards Association directives
	Battery		Double insulated
	Meets Underwriters' Laboratories safety requirements		Inspected and licensed by TÜV Product Services
CAT III	Overvoltage (Installation) Category III, Pollution Degree 2 per IEC1010-1 refers to the level of Impulse Withstand Voltage protection provided. Typical locations include; Mains, wall outlets, main distribution levels connected closer to the supply system but less than the primary supply system (CAT IV).		

How to Get Started

If you are familiar with the Fluke 80 Series DMM, read “Using the Current Output Functions,” review the tables and figures in “Getting Acquainted with the Meter,” and begin using your meter.

If you are unfamiliar with Fluke 80 Series DMMs, or DMMs in general, read “Measuring Electrical Parameters” in addition to the sections referenced in the previous paragraph.

The sections following “Using the Current Output Functions” contain information about the power-up options, and battery and fuse replacement instructions.

Later, use the Quick Reference Card to refresh your memory about the various functions and features that you can use.

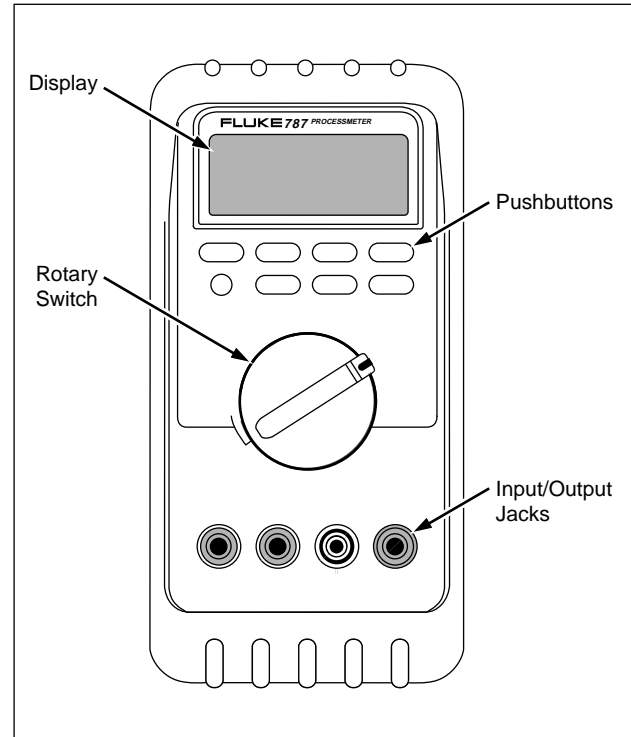

ee014f.eps

Figure 1. Fluke 787 ProcessMeter

Getting Acquainted with the Meter

To become familiar with the features and functions of the meter, study the following figures and tables.

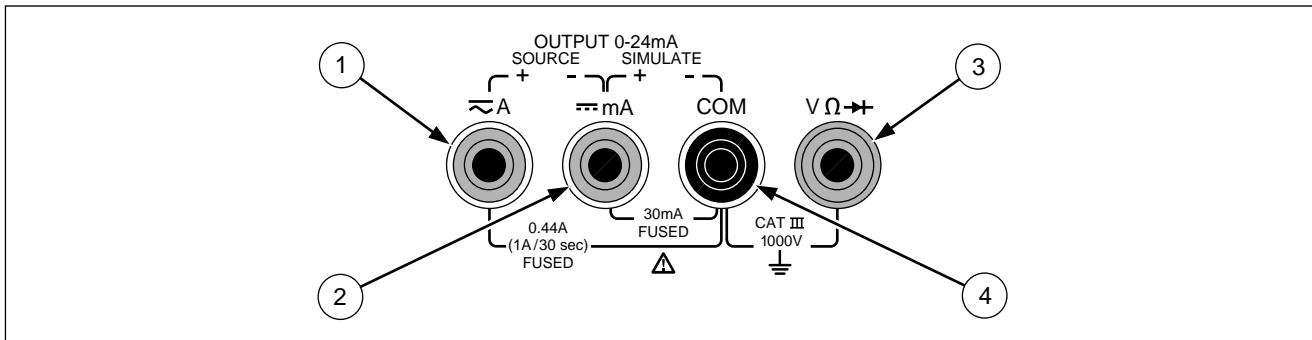

- Figure and Table 2 describe the input/output jacks.
- Figure and Table 3 describe the input functions you get with the first five rotary switch positions.
- Figure and Table 4 describe the output functions you get with the last two rotary switch positions.
- Figure and Table 5 describe the functions of the pushbuttons.
- Figure and Table 6 explain what all the elements of the display indicate.



ee001f.eps

Figure 2. Input/Output Jacks

Table 2. Input/Output Jacks

Item	Jack	Measurement Functions	Source Current Function	Simulate Transmitter Function
①	 A	Input for current to 440 mA continuous. (1A for up to 30 seconds.) Fused with a 440 mA fuse.	Output for dc current to 24 mA.	
②	 mA	Input for current to 30 mA. Fused with a 440 mA fuse.	Common for dc current output to 24 mA.	Output for transmitter simulation to 24 mA. (Use in series with an external loop supply.)
③	V Ω 	Input for voltage to 1000V, Ω , continuity, and diode test.		
④	COM	Common for all measurements.		Common for transmitter simulation to 24 mA. (Use in series with an external loop supply.)

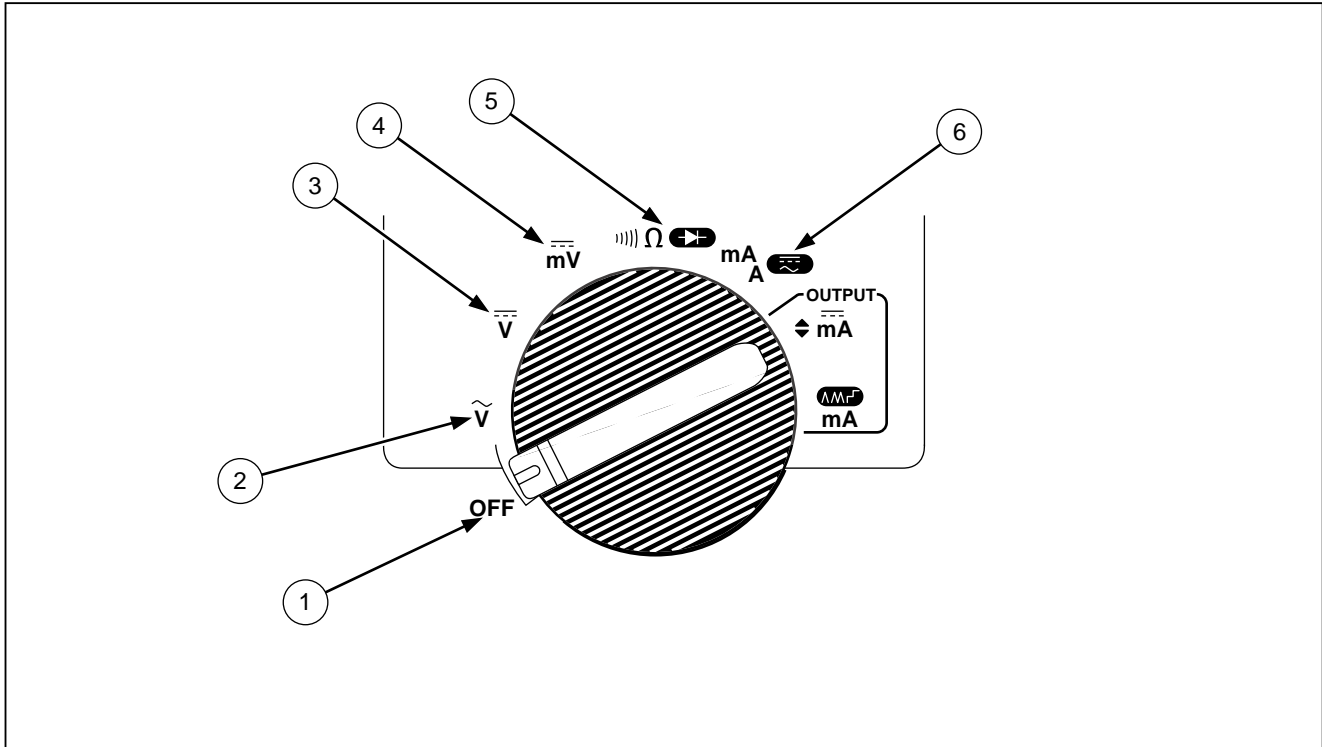











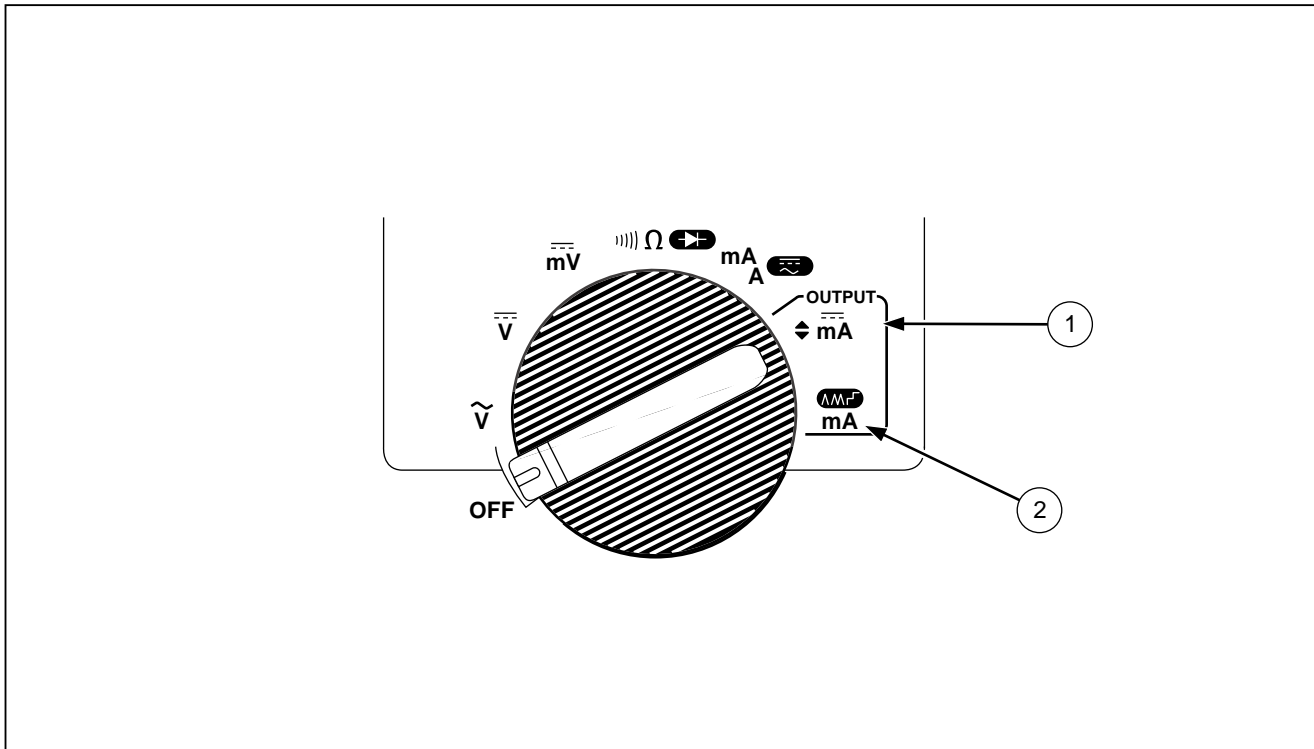

Figure 3. Rotary Switch Positions for Measurements

ee002f.eps

Table 3. Rotary Switch Positions for Measurements

No.	Position	Function(s)	Pushbutton Actions
①	OFF	Meter off	
②	V ~	Default: measure ac V  Hz Frequency counter	 Selects a MIN, MAX, or AVG action (see pg. 18)  Selects a fixed range (hold 1 second for auto range)  Toggles TouchHold  Toggles relative reading (sets a relative zero point)
③	= V	Measure dc V	Same as above
④	= mV	Measure dc mV	Same as above
⑤	 Ω 	Default: measure Ω  for continuity BLUE  test	Same as above, except diode test has only one range
⑥	mA A 	<i>High test lead in</i>  A: measure A dc BLUE selects ac <i>High test lead in</i> = mA: measure mA dc	Same as above, except there is only one range for each input jack position, 30 mA or 1A



ee008.eps

Figure 4. Rotary Switch Positions for mA Output

Table 4. Rotary Switch Positions for mA Output

No.	Position	Default Function	Pushbutton Actions
①	OUTPUT ◆ mA	<i>Test leads in</i> SOURCE: Source 0% mA <i>Test leads in</i> SIMULATE: Sink 0% mA	% STEP ▲ or ▼: Adjusts output up or down to the next 25% step COARSE ▲ or ▼: Adjusts output up or down 0.1 mA FINE ▲ or ▼: Adjusts output up or down 0.001 mA
②	OUTPUT mA 	<i>Test leads in</i> SOURCE: Source repeating 0% -100%-0% slow ramp (Λ) <i>Test leads in</i> SIMULATE: Sink repeating 0% -100%-0% slow ramp (Λ)	BLUE cycles through: <ul style="list-style-type: none"> • Fast repeating 0% -100% - 0% ramp (Λ on display) • Repeating 0% -100% - 0% ramp in 25% steps (┌ on display) • Slow repeating 0% -100% - 0% ramp (Λ on display)

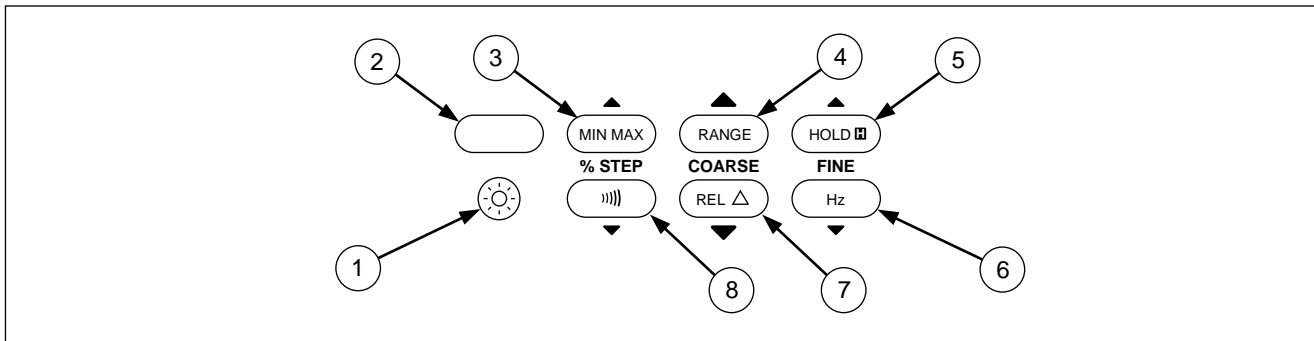













ee003f.eps

Figure 5. Pushbuttons

Table 5. Pushbuttons

No.	Pushbutton	Function(s)
①		Toggles the backlight
②	 (BLUE)	Rotary switch in mA A position and test lead plugged into A jack: Toggles between ac and dc ampere measure Rotary switch in Ω position: Selects diode test function () Rotary switch in OUTPUT mA position: Cycles through <ul style="list-style-type: none"> • Slow repeating 0% -100% - 0% ramp (on display) • Fast repeating 0% -100% - 0% ramp (on display) • Repeating 0% -100% - 0% ramp in 25% steps (on display)

Table 5. Pushbuttons (cont.)

No.	Pushbutton	Function(s)
③	  % STEP	<i>Measuring:</i> Selects a MIN, MAX, or AVG action (see pg. 18) <i>mA Output:</i> Adjusts mA output up to the next higher 25% step
④	  COARSE	<i>Measuring:</i> Selects a fixed range (hold for 1 second for auto range) <i>mA Output:</i> Adjusts output up 0.1 mA
⑤	  FINE	<i>Measuring:</i> Toggles TouchHold, or in MIN MAX recording, suspends recording <i>mA Output:</i> Adjusts output up 0.001 mA
⑥	FINE  	<i>Measuring:</i> Toggles between frequency counter and ac voltage measurement functions <i>mA Output:</i> Adjusts output down 0.001 mA
⑦	COARSE  	<i>Measuring:</i> Toggles relative reading (sets a relative zero point) <i>mA Output:</i> Adjusts output down 0.1 mA
⑧	% STEP  	<i>Measuring:</i> Toggles between Ω measure and continuity functions <i>mA Output:</i> Adjusts mA output down to the next lower 25% step

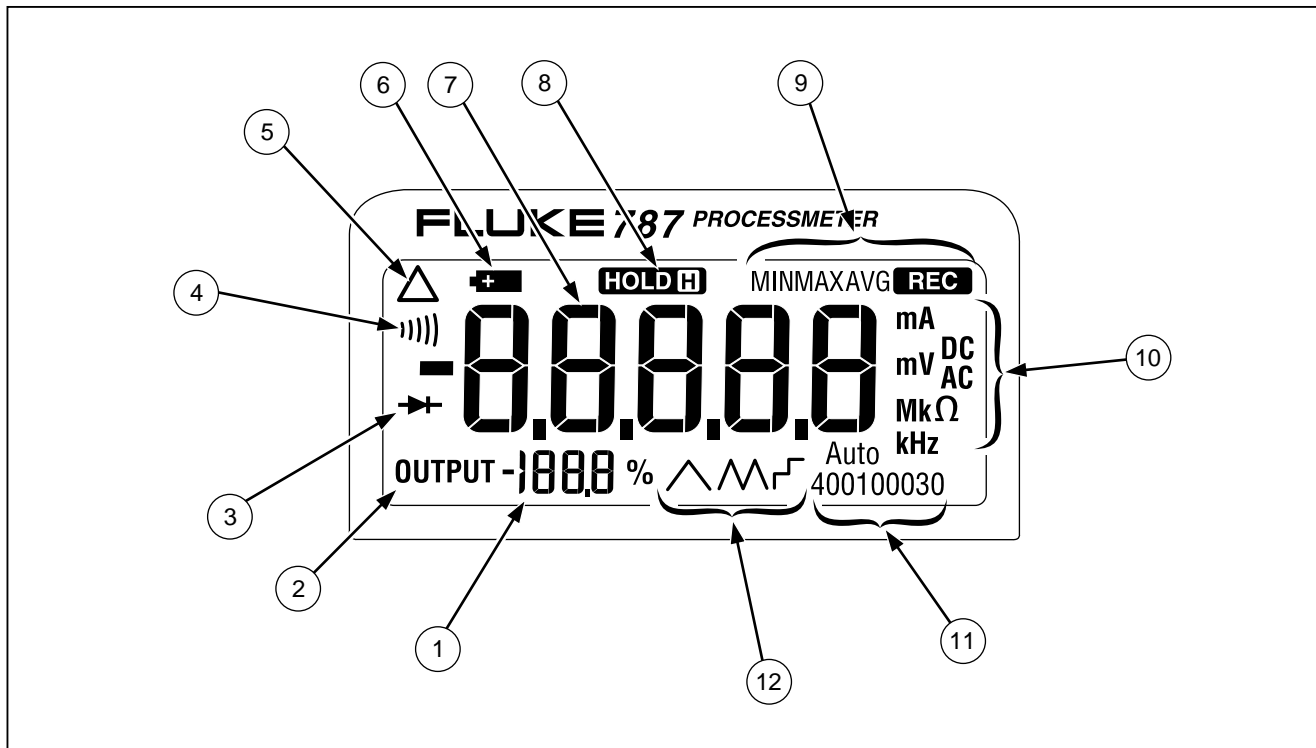

Figure 6. Elements of the Display

ee004f.eps

Table 6. Display







No.	Element	Meaning
①	Percentage display	Shows the mA measured value or output level in %, in a 0-20 mA or 4-20 mA scale (change scales with power-up option)
②	OUTPUT	Lights when mA output (source or simulate) is active
③		Lights in diode test function
④))))	Lights in continuity function
⑤	△	Lights when relative reading is on
⑥		Lights when the battery is low
⑦	Numerals	Show the input or output value
⑧		Lights when TouchHold is on
⑨	MINMAXAVG 	<p>MIN MAX recording status indicators:</p> <p>MIN means the display is showing the minimum recorded value.</p> <p>MAX means the display is showing the maximum recorded value.</p> <p>AVG means the display is showing the average value since starting recording (up to about 35 hours continuous recording time).</p> <p> means MIN MAX recording is on.</p>

Table 6. Display (cont.)

No.	Element	Meaning
⑩	mA, DC, mV, AC, M or kΩ, kHz	Show the input or output units and multipliers associated with the numerals
⑪	Auto 400100030	Range status indicators: Auto means autoranging is on. The number plus the unit and multiplier indicate the active range.
⑫	∧ ∞ ⌋	One of these lights in mA ramping or step output (rotary switch position mA ): ∧ means slow continuous 0% - 100% - 0% ramping. ∞ means fast continuous 0% - 100% - 0% ramping. ⌋ means ramping in 25% steps.

Measuring Electrical Parameters

The proper sequence for taking measurements is as follows:

1. Plug the test leads into the appropriate jacks.
2. Set the rotary knob.
3. Touch the probes to the test points.

Input Impedance

For the voltage measurement functions, input impedance is 10 M Ω . See the specifications for more information.

Ranges

A measurement range determines the highest value the meter can measure. Most meter measurement functions have more than one range (see the Specifications).

Being in the right range is important:

- If the range is too low, the display shows **OL** (overload).
- If the range is too high, the meter will not be displaying its most accurate measurement .

The meter normally automatically selects the lowest range that will measure the applied input signal (Auto showing on the display). Press **RANGE** if you want to lock the range. Each time you press **RANGE** , the meter selects the next higher range.

If you have locked the range, the meter resumes auto ranging when you change to another measurement function or you press **RANGE** and hold it for 1 second.

Measuring a Composite Signal



Because the input is dc-coupled, to measure an ac voltage or frequency with a dc bias, you must manually select the range specified in Table 7. For example, to measure 100 mV ac with 20 V dc superimposed, select the 4 V range.

Table 7. Range Requirements for Measuring a Composite Signal

Range (ac)	Max. Allowable AC + DC
400.0 mV	3 V
4.000 V	30 V
40.00 V	300 V
400.0 V	400 V
1000 V	1000 V

Testing Diodes

To test a single diode:

1. Insert the red test lead into the $V\Omega$  jack and black test lead into the COM jack.
2. Set the rotary switch to Ω  .
3. Press the BLUE pushbutton so that the  symbol is on the display.
4. Touch the red probe to the anode and the black probe to the cathode (side with band or bands). The meter should indicate the appropriate diode voltage drop.
5. Reverse the probes. The meter should display OL, indicating a high impedance.
6. The diode is good if it passes the tests in steps 4 and 5.

Displaying Minimum, Maximum, and Average

MIN MAX recording stores the lowest and highest measurements, and maintains the average of all measurements.

Press **(MIN MAX)** to turn on MIN MAX recording. Readings are stored until you turn the meter off, switch to another measurement or source function, or turn MIN MAX off. The beeper sounds when a new maximum or minimum is recorded. Auto power-off is disabled and auto ranging is turned off during MIN MAX recording.

Press **(MIN MAX)** again to cycle through the MAX, MIN, and AVG displays. Press and hold **(MIN MAX)** for 1 second to erase stored measurements and exit .

If MIN MAX recording is on continuously for over 40 hours, minimum and maximum readings are still recorded, but the displayed average no longer changes.

In MIN MAX recording, press **(HOLD)** to suspend recording; press **(HOLD)** again to resume recording.

Using TouchHold

Note

You must have MIN MAX recording off to use TouchHold.

Warning

To avoid possible electric shock, do not use TouchHold to determine if dangerous voltage is present. TouchHold will not capture unstable or noisy readings.

Activate TouchHold[®] if you want the meter to freeze the display on each new stable reading (except in the frequency counter function). Press **HOLD** to activate TouchHold. This feature allows you to take measurements in situations in which it is difficult to look at the display. The meter beeps and updates the display with each new stable reading.

Compensating for Test Lead Resistance

Use the relative reading feature (Δ on the display) to set the present measurement as a relative zero. A common use for this is to compensate for test lead resistance when measuring Ω .

Select the Ω measure function, touch the test leads together, then press **REL Δ** . Until you press **REL Δ** again, or switch to another measurement or source function, the readings on the display will subtract the lead resistance.

Using the Current Output Functions

The meter provides steady, stepped, and ramped current output for testing 0-20 mA and 4-20 mA current loops.

You can choose source mode, in which the meter supplies the current, or simulate mode, in which the meter regulates current in an externally-powered current loop.

Source Mode

Source mode is selected automatically by inserting the test leads into the SOURCE + and – jacks as shown in Figure 7. Use source mode whenever you need to supply

current into a passive circuit such as a current loop with no loop supply. Source mode depletes the battery faster than simulate mode, so use simulate mode whenever possible.

The display looks the same in source and simulate modes. The way to tell which mode is in use is to see which pair of output jacks is in use.

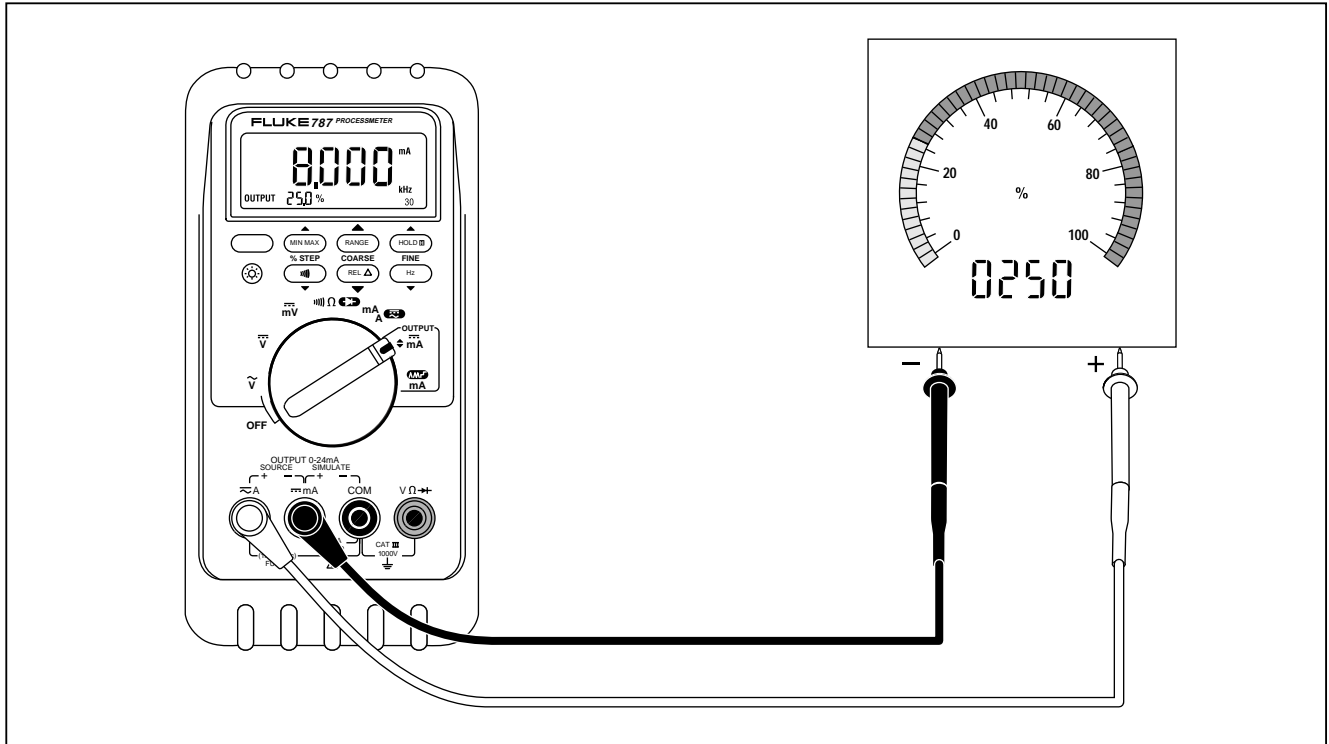

Figure 7. Sourcing Current

ee010f.eps

Simulate Mode

Simulate mode is so named because the meter simulates a current loop transmitter. Use simulate mode when an external dc voltage of 24 to 30V is in series with the current loop under test.

Caution

Set the rotary switch to one of the mA output settings BEFORE you connect the test leads to a current loop. Otherwise, a low impedance from the other rotary switch positions could be presented to the loop, causing up to 50 mA to flow in the loop.

Simulate mode is selected automatically by inserting the test leads into the SIMULATE + and – jacks as shown in Figure 8. Simulate mode conserves battery life, so use it instead of source mode whenever possible.

The display looks the same in source and simulate modes. The way to tell which mode is in use is to see which pair of output jacks is in use.

Changing the Current Span

The meter's current output span has two settings (with overrange to 24 mA):

- 4 mA = 0%, 20 mA = 100% (factory default)
- 0 mA = 0%, 20 mA = 100%

To find out which span is selected, short the OUTPUT SOURCE + and – jacks, turn the rotary switch to OUTPUT \blacklozenge mA, and observe the 0% output level.

To toggle and save the current output span in nonvolatile memory (retained when the power is turned off):

1. Turn off the meter.
2. Hold down the **RANGE** pushbutton while you turn the rotary switch to OUTPUT \blacklozenge mA.
3. Wait at least 2 seconds, then release **RANGE**.

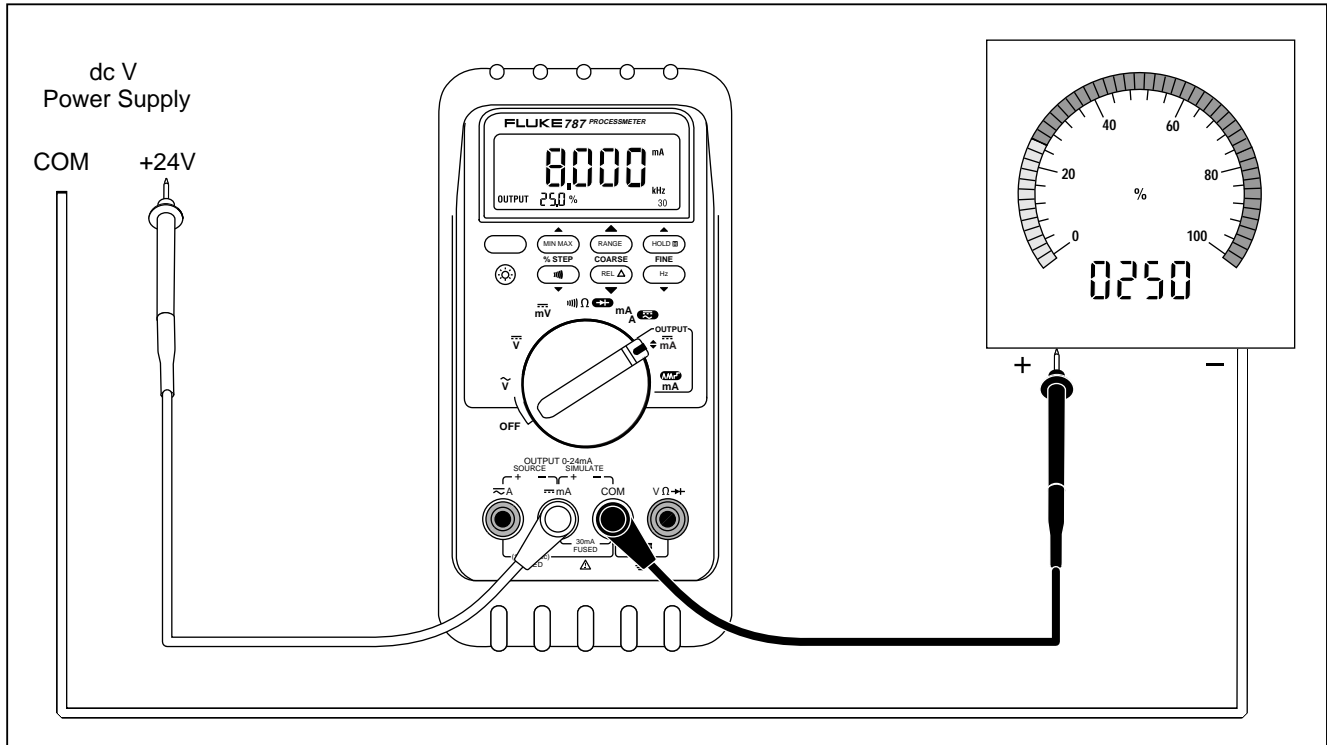

Figure 8. Simulating a Transmitter

ee011f.eps

Producing a Steady mA Output

When the rotary switch is in the OUTPUT \blacklozenge mA position, and the OUTPUT jacks are connected to an appropriate load, the meter produces a steady mA dc output. The meter begins sourcing or simulating 0%. Use the pushbuttons to adjust the current as shown in Table 8.







Select either sourcing or simulating by choosing the SOURCE or SIMULATE output jacks.

If the meter cannot deliver the programmed current because the load resistance is too high or the loop supply voltage is too low, dashes (-----) appear on the numeric display. When the impedance between the SOURCE jacks is low enough, the meter will resume sourcing.

Note

The STEP pushbuttons described on the next page are available when the meter is producing a steady mA output. The STEP pushbuttons go to the next multiple of 25%.

Table 8. mA Output Adjust Pushbuttons

Pushbutton	Adjustment
 RANGE COARSE	Adjusts up 0.1 mA
 HOLD  FINE	Adjusts up 0.001 mA
FINE  Hz	Adjusts down 0.001 mA
COARSE REL  	Adjusts down 0.1 mA

Manually Stepping the mA Output

When the rotary switch is in the OUTPUT  mA position, and the OUTPUT jacks are connected to an appropriate load, the meter produces a steady mA dc output. The meter begins sourcing or simulating 0%. Use the pushbuttons to step the current up and down in 25% steps as shown in Table 9. See Table 10 for mA values at each 25% step.

Select either sourcing or simulating by choosing the SOURCE or SIMULATE output jacks.

If the meter cannot deliver the programmed current because the load resistance is too high or the loop supply voltage is too low, dashes (-----) appear on the numeric display. When the impedance between the SOURCE jacks is low enough, the meter will resume sourcing.

Note

The COARSE and FINE adjustment pushbuttons described on the previous page are available when you are manually stepping the mA output.

Table 9. mA Stepping Pushbuttons



Pushbutton	Adjustment
	Adjusts up to the next higher 25% step
	Adjusts down to the next lower 25% step

Table 10. mA Step Values

Step	Value (for each span setting)	
	4 to 20 mA	0 to 20 mA
0%	4.000 mA	0.000 mA
25%	8.000 mA	5.000 mA
50%	12.000 mA	10.000 mA
75%	16.000 mA	15.000 mA
100%	20.000 mA	20.000 mA
125%	24.000 mA	
120%		24.000 mA

Auto Ramping the mA Output

Auto ramping gives you the ability to continuously apply a varying current stimulus from the meter to a transmitter, while your hands remain free to test the response of the transmitter. Select either sourcing or simulating by choosing the SOURCE or SIMULATE jacks.

When the rotary switch is in the OUTPUT mA  position, the meter produces a continuously repeating 0% - 100% - 0% ramp in your choice of three ramp waveforms:

 0% - 100% - 0% 40-second smooth ramp, (default)

 0% - 100% - 0% 15-second smooth ramp

 0% - 100% - 0% Stair-step ramp in 25% steps, pausing 5 seconds at each step. Steps are listed in Table 10.

The ramp times are not adjustable. Press the BLUE pushbutton to cycle through the three waveforms.

Note

At any time during auto ramping, you can freeze the ramp simply by moving the rotary switch to the  mA position. Then you can use the COARSE, FINE, and % STEP adjust pushbuttons to make adjustments.



Power-Up Options

To select a power-up option, hold down the pushbutton shown in Table 11 while turning the rotary switch from OFF to any on position. Wait 2 seconds before you release the pushbutton after powering up the meter. The meter beeps to acknowledge the power-up option.

Only the setting for current span is retained when the power is turned off. The others have to be repeated for each operating session.

You may activate more than one power-up option by holding down more than one pushbutton.

Table 11. Power-Up Options

Option	Pushbutton	Default	Action Taken
Change current span 0% setting		Remembers last setting	Toggles between 0 and 4 mA
Disable beeper		Enabled	Disables beeper
Disable auto power-off	BLUE	Enabled	Disables the feature that turns off the meter power after 30 minutes of inactivity. Auto power off is disabled regardless of this option if MIN MAX recording is on.

Battery Life

Warning

To avoid false readings, which could lead to possible electric shock or personal injury, replace the battery as soon as the battery indicator () appears.

Table 12 shows typical alkaline battery life. To preserve battery life:

- Use current simulation instead of sourcing when possible.
- Avoid using the backlight.
- Do not disable the automatic power-off feature.
- Turn the meter off when you are not using it.

Table 12. Typical Alkaline Battery Life

Meter Operation	Hours
Measuring any parameter or simulating current	80
Sourcing 12 mA into 500Ω	12

Using the Holster and Flex-Stand

The meter is supplied with a snap-on holster that absorbs shocks and protects the meter from rough handling. You can turn the meter over in the holster to protect the face of the meter from scratches when carrying the meter.

The holster is equipped with a Flex-Stand bail. Some uses of the holster with Flex-Stand are shown in Figure 9.

Maintenance

This section provides some basic maintenance procedures. Repair, calibration, servicing not covered in this manual must be performed by qualified personnel. For maintenance procedures not described in this manual, contact a Fluke Service Center.

General Maintenance

Periodically wipe the case with a damp cloth and detergent; do not use abrasives or solvents.

Calibration

Calibrate your meter once a year to ensure that it performs according to its specifications. Contact a Fluke Service Center for instructions.

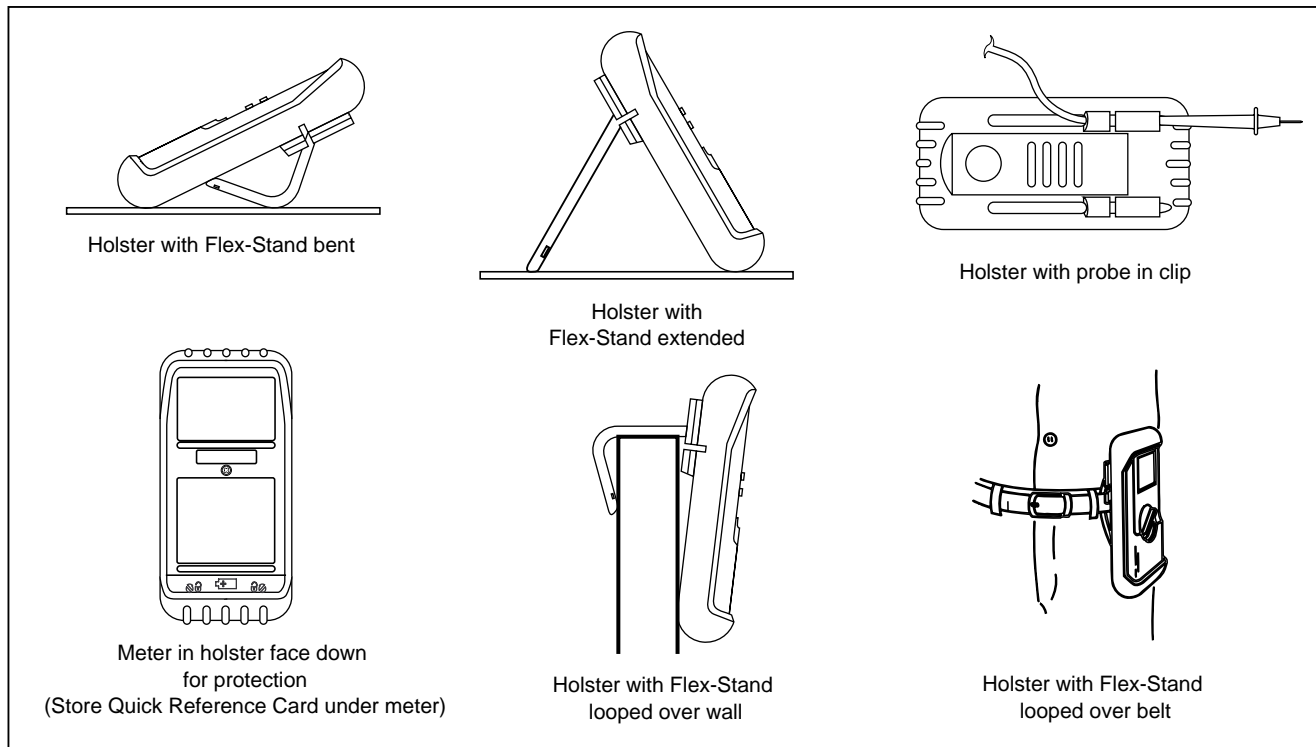

Figure 9. Using the Holster and Flex-Stand

ee009f.eps

Replacing the Battery

⚠ Warning

To avoid electrical shock, remove test leads from the meter before you open the battery door.

Close and latch the battery door before you use the meter.

Remove test leads from the meter before you open the battery door.

Replace the battery as follows. Refer to Figure 10. Use an alkaline 9V battery, type ANSI/NEDA 1604A or IEC 6LR61.

1. Remove the test leads and set the rotary switch to OFF.
2. With a standard blade hand screwdriver, turn each battery door screw counterclockwise so that the slot is parallel with the screw picture molded into the case.
3. Lift off the battery door.

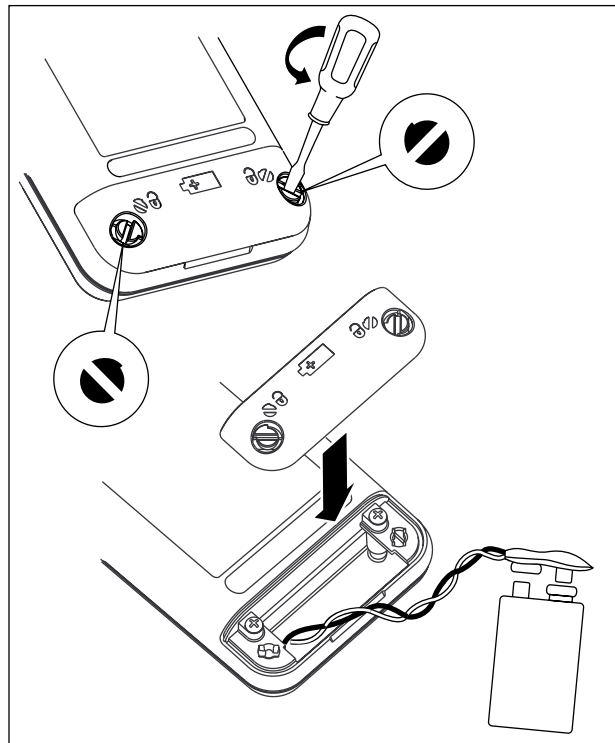

ee007f.eps

Figure 10. Replacing the Battery

Replacing a Fuse

Warning

To avoid personal injury or damage to the meter, use only the specified replacement fuse, 440 mA 1000V fast-blow, Fluke PN 943121.

Both current input jacks are fused with a separate 440 mA fuse. To determine if a fuse is blown:

1. Turn the rotary switch to mA A .
2. Plug the black test lead into COM, and the red test lead into \approx A.
3. Using an ohmmeter, check the resistance between the meter test leads. If the resistance is about 1Ω , the fuse is good. An open means the fuse is blown.
4. Move red test lead to \approx mA.
5. Using an ohmmeter, check the resistance between the meter test leads. If the resistance is about 14Ω , the fuse is good. An open means the fuse is blown.

If a fuse is blown, replace it as follows. Refer to Figure 11 as necessary:

1. Remove the test leads from the meter and turn the rotary switch to OFF.
2. Remove the battery door.
3. Remove the three Phillips-head screws from the case bottom and turn the case over.
4. Gently lift the bottom of the front of the case (nearest the input/output jacks) until the top unsnaps from the rear half of the case.
5. Replace the blown fuse with the exact type specified: 440 mA 1000V fast-blow fuse, Fluke PN 943121. Both fuses are the same type.
6. Make sure the rotary switch is in the OFF position.
7. Fit the top of case together, engaging the two snaps (item ①). Make sure that the gasket is properly seated.
8. Close the case and reinstall the three screws.
9. Replace the battery door.

If the Meter does not Work

- Examine the case for physical damage. If there is damage, make no further attempt to use the meter, and contact a Fluke Service Center.
- Check the battery, fuses, and test leads.
- Review this manual to make sure you are using the correct jacks and rotary switch position.

If the meter still does not work, contact a Fluke Service Center. If the meter is under warranty, it will be repaired or replaced (at Fluke's option) and returned at no charge. See the Warranty on the back of the title page for terms. If the warranty has lapsed, the meter will be repaired and returned for a fixed fee. Contact a Fluke Service Center for information and price.

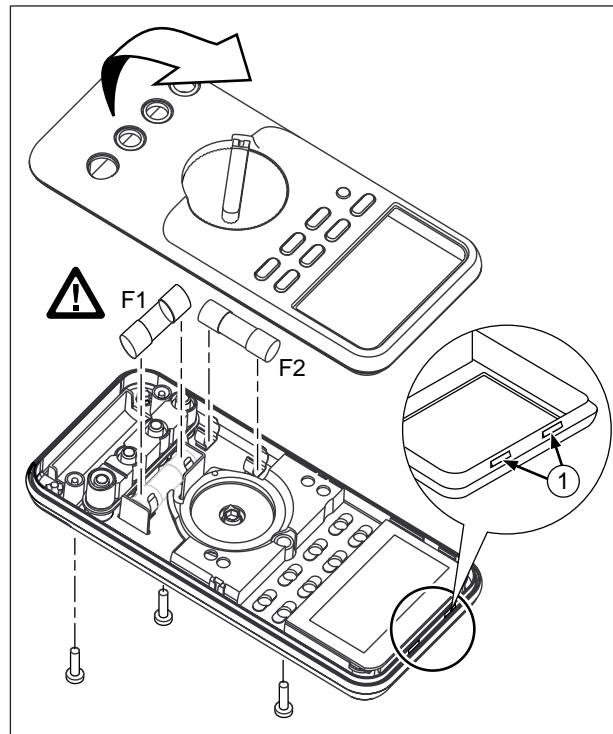

ee012f.eps

Figure 11. Replacing a Fuse

Replacement Parts and Accessories

Warning

To avoid personal injury or damage to the meter, use only the specified replacement fuse, 440 mA 1000V fast-blow, Fluke PN 943121.

Note

When servicing the meter, use only the replacement parts specified here.

Replacement parts and some accessories are shown in Figure 12 and listed in Table 13. Many more DMM accessories are available from Fluke. For a catalog, contact your nearest Fluke distributor.

To find out how to order parts or accessories use the telephone numbers or addresses shown on page 1 of this manual.

Table 13. Replacement Parts

Item	Description	Fluke PN or Model no.	Quantity
BT1	9V battery, ANSI/NEDA 1604A or IEC 6LR61	614487	1
CG81Y	Holster, Yellow	CG81G	1
△ F1, 2	Fuse, 440 mA, 1000V fast-blow	943121	2
MP85	Case top	619962	1
MP86	Case bottom	619939	1
H2, 3, 4	Case screw	832246	3
MP89, 90	Non-skid foot	824466	2
MP8	O-ring for input/output receptacle	831933	1
MP92	Battery door	619947	1
H5, 6	Battery door fasteners	948609	2
S1	Keypad	646932	1
TL75	Standard test lead set	TL75	1
AC70A	Alligator clips for use with TL75 test lead set	AC70A	1
TL20	Industrial test lead set	TL20	Option
TM1	Product Overview Manual	1586717	1
TM2	Users Manual (CD-ROM)	1586721	1
TM3	Calibration Manual (not shown)	641891	Option

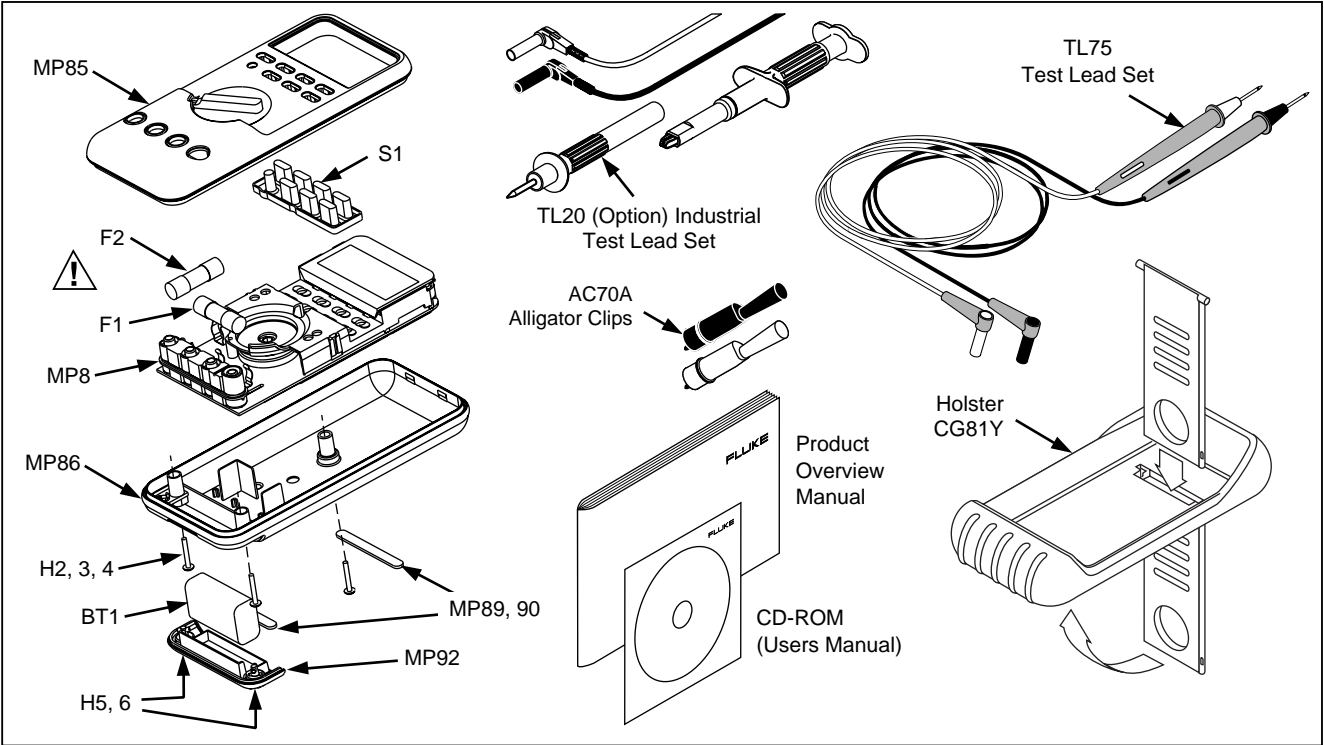

Figure 12. Replacement Parts

ee015c.eps

Specifications

All specifications apply from +18°C to +28°C unless stated otherwise.

All specifications assume a 5 minute warmup period.

The standard specification interval is 1 year.

Note

“Counts” means number of increments or decrements of the least significant digit.

DC Volts Measurement

Range (V dc)	Resolution	Accuracy, \pm (% of Reading + Counts)
4.000	0.001V	0.1% + 1
40.00	0.01V	0.1% + 1
400.0	0.1V	0.1% + 1
1000	1V	0.1% + 1

Input impedance: 10 M Ω (nominal), < 100 pF
Normal mode rejection ratio: >60 dB at 50 Hz or 60 Hz
Common mode rejection ratio: >120 dB at dc, 50 Hz, or 60 Hz
Overvoltage protection: 1000V

DC Millivolts Measurement

Range (mV dc)	Resolution	Accuracy (% of Reading + Counts)
400.0	0.1 mV	0.1% + 1

AC Volts Measurement

Range (ac)	Resolution	Accuracy, \pm (% of Reading + Counts)		
		50 Hz to 60 Hz	45 Hz to 200 Hz	200 Hz to 500 Hz
400.0 mV	0.1 mV	0.7% + 4	1.2% + 4	7.0% + 4
4.000V	0.001V	0.7% + 2	1.2% + 4	7.0% + 4
40.00V	0.01V	0.7% + 2	1.2% + 4	7.0% + 4
400.0V	0.1V	0.7% + 2	1.2% + 4	7.0% + 4
1000V	1V	0.7% + 2	1.2% + 4	7.0% + 4

Specifications are valid from 5% to 100% of amplitude range.

AC conversion: true rms

Maximum crest factor: 3

For non-sinusoidal waveforms, add \pm (2% reading + 2% f.s.) typical

Input impedance: 10 M Ω (nominal), < 100 pF, ac-coupled

Common mode rejection ratio: >60 dB at dc, 50 Hz, or 60 Hz

AC Current Measurement

Range 45 Hz to 2 kHz	Resolution	Accuracy, \pm (% of Reading + Counts)	Typical Burden Voltage
1.000A (Note)	0.001A	1% + 2	1.5V/A

Note: 440 mA continuous, 1A 30 seconds maximum

Specifications are valid from 5% to 100% of amplitude range.

AC conversion: true rms

Maximum crest factor: 3

For non-sinusoidal waveforms, add \pm (2% reading + 2% f.s.) typical

Overload protection 440 mA, 1000V fast-blow fuse

DC Current Measurement

Range	Resolution	Accuracy, \pm (% of Reading + Counts)	Typical Burden Voltage
30.000 mA	0.001 mA	0.05% + 2	14 mV/mA
1.000A (Note)	0.001A	0.2% + 2	1.5V/A

Note: 440 mA continuous, 1A 30 seconds maximum

Overload protection: 440 mA, 1000V fast-blow fuse

Ohms Measurement

Range	Resolution	Measurement Current	Accuracy, \pm(% of Reading + Counts)
400.0 Ω	0. 1 Ω	220 μ A	0.2% + 2
4.000 k Ω	0.001 k Ω	59 μ A	0.2% + 1
40.00 k Ω	0.01 k Ω	5.9 μ A	0.2% + 1
400.0 k Ω	0.1 k Ω	590 nA	0.2% + 1
4.000 M Ω	0.001 M Ω	220 nA	0.35% + 3
40.00 M Ω	0.01 M Ω	22 nA	2.5% + 3
<p><i>Overload protection: 1000V</i> <i>Open circuit voltage: <3.9V</i></p>			

Frequency Counter Accuracy

Range	Resolution	Accuracy, \pm (% of Reading + Counts)
199.99 Hz	0.01 Hz	0.005% + 1
1999.9 Hz	0.1 Hz	0.005% + 1
19.999 kHz	0.001 kHz	0.005% + 1

Display updates 3 times/second at >10 Hz

Frequency Counter Sensitivity

Input Range	Minimum Sensitivity (rms Sinewave) 5 Hz to 5 kHz*
1 V	0.1 V
4 V	1 V
40 V	3 V
400 V	30 V
1000 V	300 V

* Usable 0.5 Hz to 20 kHz with reduced sensitivity.

Diode Test and Continuity Test

Diode test indication: display voltage drop: 0.2 mA nominal test current at 0.6V: 2.4V full scale, accuracy $\pm(2\% + 1 \text{ count})$

Continuity test indication: continuous audible tone for test resistance $<100\Omega$

Open circuit voltage: $<3.9\text{V}$

Short circuit current: 1.2 mA typical

Overload protection: 1000V rms

DC Current Output

Source mode:

Span: 0 mA or 4 mA to 20 mA, with overrange to 24 mA

Accuracy: 0.05% of span

Compliance voltage: 12V with battery voltage $>8.5\text{V}$

Simulate Mode:

Span: 0 mA or 4 mA to 20 mA, with overrange to 24 mA

Accuracy: 0.05% of span

Loop voltage: 24V nominal, 30V maximum, 15V minimum

Compliance voltage: 21V for 24V supply

Burden voltage: $<3\text{V}$

General Specifications

Maximum voltage applied between any jack and earth ground: 1000V

Storage temperature: -40°C to 60°C

Operating temperature: -20°C to 55°C

Operating altitude: 2000 meters maximum

Temperature coefficient: 0.05 x specified accuracy per $^{\circ}\text{C}$ for temperatures $<18^{\circ}\text{C}$ or $>28^{\circ}\text{C}$

Accuracy adders for use in RF Fields: In an RF field of 3V/m, change the accuracy specifications as follows:

For DC Millivolts Measurement, add 0.03% of range

For AC Volts Measurement, add 0.37% of range

For DC Current Measurement, 30.000 mA range, add 0.14% of range

For DC Current Output, add 0.02% of span

Accuracy for all meter functions is not specified in RF fields $> 3\text{V/m}$.

Relative humidity: 95% up to 30°C , 75% up to 40°C , 45% up to 50°C , and 35% up to 55°C

Vibration: Random 2g, 5 to 500 Hz

Shock: 1 meter drop test

Water and dust protection: Complies with IEC529 IP52
(normal operating vacuum used for dust test)

Safety: Complies with IEC1010-1, ANSI/ISA S82.01-1994 and CAN/CSA C22.2 No. 1010.1-92 Overvoltage Category III.

Certifications: CSA, UL, TÜV

Power requirements: Single 9V battery (ANSI/NEDA 1604A or IEC 6LR61)

Size: 32 mm H x 87 mm W x 187 mm L (1.25 in H x 3.41 in W x 7.35 in L);

With holster and Flex-Stand: 52 mm H x 98 mm W x 201 mm L (2.06 in H x 3.86 in W x 7.93 in L)

Weight: 369 g (13 oz);

With holster and Flex-Stand: 638 g (22.5 oz)

—A—

Auto

Ramping, 17, 26

Ranging, 17

Stepping, 17

—B—

Battery

Replacement, 30

Buttons, 12

—C—

Calibrating the meter, 28

Compensating for test lead resistance, 19

Composite Signals, 17

Current output

Compliance, 24

Load impedance, 24

Ramping, auto, 26

Simulating a transmitter, 22

Sourcing, 20

Span (4-20 mA or 0-20 mA), 22

Steady, 24

Stepping, auto, 26

Stepping, manually, 25

With external loop supply, 22

—D—

Diodes, testing, 18

Display, 15

—F—

Flex-Stand, 28

Freezing a reading (TouchHold), 19

Fuse, checking and replacing, 31

—H—

Holster, 28

—I—

Input/Output jacks, 7

—J—

Jacks, 7

—K—

Knob positions, 9, 11

—L—

Loop supply, external, 22

M—

mA output. *See* Current output

Mailing address for Fluke, 2

Maintenance, 28

Malfunction, 32

Measuring, 17

MIN MAX recording, 18

—O—

Offset, programming an, 19

Options, power-up, 27

Output. *See* Current output

—P—

Parts, replacement, 34

Power-up options, 27

Pushbuttons, 12

—R—

Range

Auto, 17

Locking, 17

Ranges, 17

Relative reading, 19

Rotary switch positions, 9, 11

—S—

Safety information, 2

Screen, 15

Service and sales, 1

Settings, 27

Simulating. *See* Current output

Sourcing. *See* Current output

Specifications, 36

Switch positions, 9, 11

Symbols, international, 4

—T—

Telephone numbers, 1

TouchHold, 19

—W—

Warranty. *See* back of Title Page

Service, 32

WWW address for Fluke, 2

