

Application Note

AN- EVAL-2QR2280Z-20W

20W5V Evaluation Board with Quasi-Resonant CoolSET[®] ICE2QR2280Z

Power Management & Supply



Published by
Infineon Technologies AG
81726 Munich, Germany
© 2010 Infineon Technologies AG
All Rights Reserved.

Legal Disclaimer

The information given in this document shall in no event be regarded as a guarantee of conditions or characteristics. With respect to any examples or hints given herein, any typical values stated herein and/or any information regarding the application of the device, Infineon Technologies hereby disclaims any and all warranties and liabilities of any kind, including without limitation, warranties of non-infringement of intellectual property rights of any third party.

Information

For further information on technology, delivery terms and conditions and prices, please contact the nearest Infineon Technologies Office (www.infineon.com).

Warnings

Due to technical requirements, components may contain dangerous substances. For information on the types in question, please contact the nearest Infineon Technologies Office. Infineon Technologies components may be used in life-support devices or systems only with the express written approval of Infineon Technologies, if a failure of such components can reasonably be expected to cause the failure of that life-support device or system or to affect the safety or effectiveness of that device or system. Life support devices or systems are intended to be implanted in the human body or to support and/or maintain and sustain and/or protect human life. If they fail, it is reasonable to assume that the health of the user or other persons may be endangered.

AN-EVAL-2QR2280Z-20W**Revision History:** **3 Aug 2012****V1.1**

Previous Version: V1.0

Page	Subjects (major changes since last revision)
11, 19	Revise BOM and reference

20W5V Evaluation Board with Quasi-Resonant CoolSET[®] ICE2QR2280Z
License to Infineon Technologies Asia Pacific Pte Ltd

AN-PS0055

Wong Siew Teng WinsonWinson.wong@infineon.com**Kok Siu Kam Eric**Eric.kok@infineon.com**Wang Zan**Zan.wang@infineon.com**We Listen to Your Comments**

Any information within this document that you feel is wrong, unclear or missing at all?

Your feedback will help us to continuously improve the quality of this document.

Please send your proposal (including a reference to this document) to:

comments@infineon.com

Table of Contents

1	Content	5
2	Evaluation Board	5
3	List of Features	5
4	Technical Specifications	6
5	Circuit Description.....	6
5.1	Mains Input and Rectification.....	6
5.2	Integrated MOSFET and PWM Control	6
5.3	Output Stage	6
5.4	Feedback Loop.....	6
6	Circuit Operation	6
6.1	Startup Operation.....	6
6.2	Normal Mode Operation.....	6
6.3	Primary side peak current control.....	7
6.4	Digital Frequency Reduction	7
6.5	Burst Mode Operation.....	7
7	Protection Features	7
7.1	Vcc under voltage and over voltage protection.....	7
7.2	Foldback point protection.....	7
7.3	Open loop/over load protection.....	8
7.4	Adjustable output overvoltage protection	8
7.5	Short winding protection	8
7.6	Auto restart for over temperature protection.....	8
8	Circuit diagram	9
8.1	PCB Top overlayer	10
8.2	PCB Bottom Layer	10
9	Component List	11
10	Transformer Construction	12
11	Test Results	13
11.1	Efficiency and standby performance	13
12	Waveforms and scope plots	16
12.1	Startup at 85Vac and 20W load.....	16
12.2	Zero Crossing Points during normal operation.....	16
12.3	Load Transient Response.....	17
12.4	Burst Mode Operation.....	17
12.5	Protection modes.....	18
13	References	19

1 Content

This application note is a description of 20W switching mode power supply evaluation board designed in a quasi resonant flyback converter topology using ICE2QR2280Z Quasi-resonant CoolSET[®]. The target application of ICE2QR2280Z are for set-top box, portable game controller, DVD player, netbook adapter and auxiliary power supply for LCD TV, etc. With the CoolMOS[®] integrated in this IC, it greatly simplifies the design and layout of the PCB. Due to valley switching, the turn on voltage is reduced and this offers higher conversion efficiency comparing to hard-switching flyback converter. With the DCM mode control, the reverse recovery problem of secondary rectify diode is relieved. And for its natural frequency jittering with line voltage, the EMI performance is better. Infineon's digital frequency reduction technology enables a quasi-resonant operation till very low load. As a result, the system efficiency, over the entire load range, is significantly improved compared to conventional free running quasi resonant converter implemented with only maximum switching frequency limitation at light load. In addition, numerous adjustable protection functions have been implemented in ICE2QR2280Z to protect the system and customize the IC for the chosen application. In case of failure modes, like open control-loop/over load, output overvoltage, and transformer short winding, the device switches into **Auto Restart Mode** or **Latch-off Mode**. By means of the cycle-by-cycle peak current limitation plus foldback point correction, the dimension of the transformer and current rating of the secondary diode can both be optimized. Thus, a cost effective solution can be easily achieved.

2 Evaluation Board

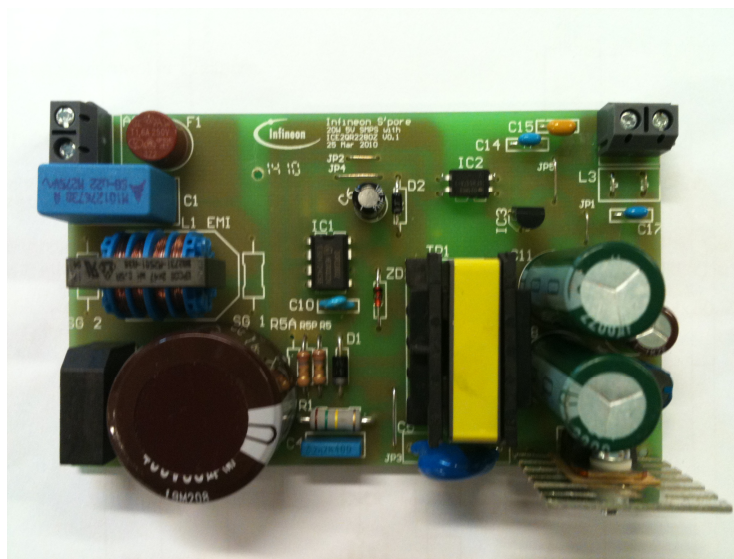

Figure 1-EVALQR-20W-ICE2QR2280Z

3 List of Features

800V avalanche rugged CoolMOS [®] with built in depletion startup cell
Quasi-resonant operation
Digital frequency reduction with decreasing load
Cycle-by-cycle peak current limitation with foldback point correction
Built-in digital soft-start
Direct current sensing with internal Leading Edge Blanking Time
VCC under voltage protection: IC stop operation, recover with softstart
VCC over voltage protection: IC stop operation, recover with softstart
Openloop/Overload protection: Auto Restart
Output overvoltage protection: Latch-off with adjustable threshold
Short-winding protection: Latch-off
Over temperature protection: Autorestart

4 Technical Specifications

Input voltage	85Vac~265Vac
Input frequency	50Hz, 60Hz
Output voltage and current	5V 4.0A
Output power	20W
Average Efficiency	>80% at full load
Standby power	<100mW@no load
Minimum switching frequency at full load, minimum input voltage	65kHz

5 Circuit Description

5.1 Mains Input and Rectification

The AC line input side comprises the input fuse F1 as overcurrent protection. The X2 Capacitors C1 and Choke L1 form a main filter to minimize the feedback of RFI into the main supply. After the bridge rectifier BR1, together with a smoothing capacitor C2, provide a voltage of 70VDC to 380 VDC depending on mains input voltage.

5.2 Integrated MOSFET and PWM Control

ICE2QR2280Z is comprised of a power MOSFET and the quasi-resonant controller; this integrated solution greatly simplifies the circuit layout and reduces the cost of PCB manufacturing. The PWM switch-on is determined by the zero-crossing input signal and the value of the up/down counter. The PWM switch-off is determined by the feedback signal V_{FB} and the current sensing signal V_{CS} . ICE2QR2280Z also performs all necessary protection functions in flyback converters. Details about the information mentioned above are illustrated in the product datasheet.

5.3 Output Stage

On the secondary side, 5V output, the power is coupled out via a schottky diode D21. The capacitors C21 provides energy buffering followed by the L-C filters L21 and C22 to reduce the output ripple and prevent interference between SMPS switching frequency and line frequency considerably. Storage capacitor C21 is designed to have an internal resistance (ESR) as small as possible. This is to minimize the output voltage ripple caused by the triangular current.

5.4 Feedback Loop

For feedback, the output is sensed by the voltage divider of Rc1 and Rc3 and compared to TL431 internal reference voltage. Cc1, Cc2 and Rc4 comprise the compensation network. The output voltage of TL431 is converted to the current signal via optocoupler IC2 and two resistors Rc5 and Rc6 for regulation control.

6 Circuit Operation

6.1 Startup Operation

Since there is a built-in startup cell in the ICE2QR2280Z, there is no need for external start up resistor, which can improve standby performance significantly.

When VCC reaches the turn on voltage threshold 18V, the IC begins with a soft start. The soft-start implemented in ICE2QR2280Z is a digital time-based function. The preset soft-start time is 12ms with 4 steps. If not limited by other functions, the peak voltage on CS pin will increase step by step from 0.32V to 1V finally. After IC turns on, the Vcc voltage is supplied by auxiliary windings of the transformer.

6.2 Normal Mode Operation

The secondary output voltage is built up after startup. The secondary regulation control is adopted with TL431 and optocoupler. The compensation network Cc1, Cc2 and Rc4 constitute the external circuitry of the error amplifier of TL431. This circuitry allows the feedback to be precisely controlled with respect to dynamically varying load conditions, therefore providing stable control.

6.3 Primary side peak current control

The MOSFET drain source current is sensed via external resistor R4 and R4A. Since ICE2QR2280Z is a current mode controller, it would have a cycle-by-cycle primary current and feedback voltage control which can make sure the maximum power of the converter is controlled in every switching cycle.

6.4 Digital Frequency Reduction

During normal operation, the switching frequency for ICE2QR2280Z is digitally reduced with decreasing load. At light load, the MOSFET will be turned on not at the first minimum drain-source voltage time, but on the n^{th} . The counter is in range of 1 to 7, which depends on feedback voltage in a time-base. The feedback voltage decreases when the output power requirement decreases, and vice versa. Therefore, the counter is set by monitoring voltage V_{FB} . The counter will be increased with low V_{FB} and decreased with high V_{FB} . The thresholds are preset inside the IC.

6.5 Burst Mode Operation

At light load condition, the SMPS enters into Active Burst Mode. At this stage, the controller is always active but the V_{cc} must be kept above the switch off threshold. During active burst mode, the efficiency increase significantly and at the same time it supports low ripple on V_{out} and fast response on load jump.

For determination of entering Active Burst Mode operation, three conditions apply:

1. the feedback voltage is lower than the threshold of V_{FBEB} (1.25V). Accordingly, the peak current sense voltage across the shunt resistor is 0.18;
2. the up/down counter is 7;
3. and a certain blanking time, 24ms (t_{BEB}).

Once all of these conditions are fulfilled, the Active Burst Mode flip-flop is set and the controller enters Active Burst Mode operation. This multi-condition determination for entering Active Burst Mode operation prevents mistrigging of entering Active Burst Mode operation, so that the controller enters Active Burst Mode operation only when the output power is really low during the preset blanking time.

During active burst mode, the maximum current sense voltage is reduced from 1V to 0.34V so as to reduce the conduction loss and the audible noise. At the burst mode, the FB voltage is changing like a sawtooth between 3.0 and 3.6V. The switching frequency is set to a fix frequency of 52kHz.

The feedback voltage immediately increases if there is a high load jump. This is observed by one comparator. As the current limit is 34% during Active Burst Mode a certain load is needed so that feedback voltage can exceed VLB (4.5V). After leaving active busrt mode, maximum current can now be provided to stabilize V_{O} . In addition, the up/down counter will be set to 1 immediately after leaving Active Burst Mode. This is helpful to decrease the output voltage undershoot

7 Protection Features

7.1 Vcc under voltage and over voltage protection

During normal operation, the V_{CC} voltage is continuously monitored. When the V_{CC} voltage falls below the under voltage lock out level (V_{CCoff}) or the V_{CC} voltage increases up to V_{CCovp} , the IC will enter into autorestart mode.

7.2 Foldback point protection

For a quasi-resonant flyback converter, the maximum possible output power is increased when a constant current limit value is used for all the mains input voltage range. This is usually not desired as this will increase additional cost on transformer and output diode in case of output over power conditions.

The internal fold back protection is implemented to adjust the V_{CS} voltage limit according to the bus voltage. Here, the input line voltage is sensed using the current flowing out of **ZC** pin, during the MOSFET on-time. As the result, the maximum current limit will be lower at high input voltage and the maximum output power can be well limited versus the input voltage.

7.3 Open loop/over load protection

In case of open control loop, feedback voltage is pulled up with internally block. After a fixed blanking time 30ms, the IC enters into auto restart mode. In case of secondary short-circuit or overload, regulation voltage V_{FB} will also be pulled up, same protection is applied and IC will auto restart.

7.4 Adjustable output overvoltage protection

During off-time of the power switch, the voltage at the zero-crossing pin **ZC** is monitored for output overvoltage detection. If the voltage is higher than the preset threshold 3.7V for a preset period 100 μ s, the IC is latched off.

7.5 Short winding protection

The source current of the MOSFET is sensed via two shunt resistors **R4** and **R4A** in parallel. If the voltage at the current sensing pin is higher than the preset threshold V_{CSSW} of 1.68V during the on-time of the power switch, the IC is latched off. This constitutes a short winding protection. To avoid an accidental latch off, a spike blanking time of 190ns is integrated in the output of internal comparator.

7.6 Auto restart for over temperature protection

The IC has a built-in over temperature protection function. When the controller's temperature reaches 140 °C, the IC will shut down switch and enters into autorestart. This can protect power MOSFET from overheated.

8 Circuit diagram

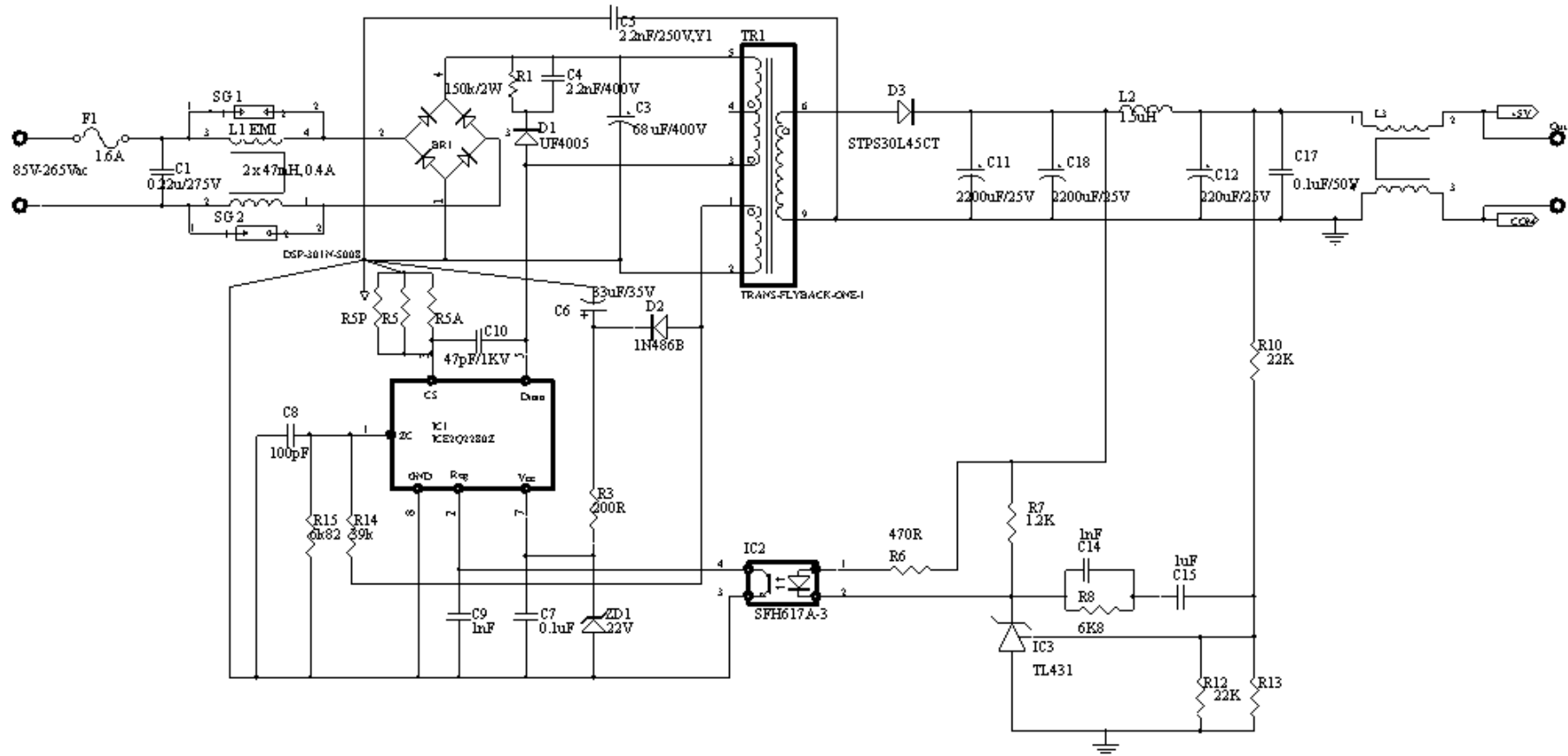

Figure 2 – Schematics

8.1 PCB Top overlayer

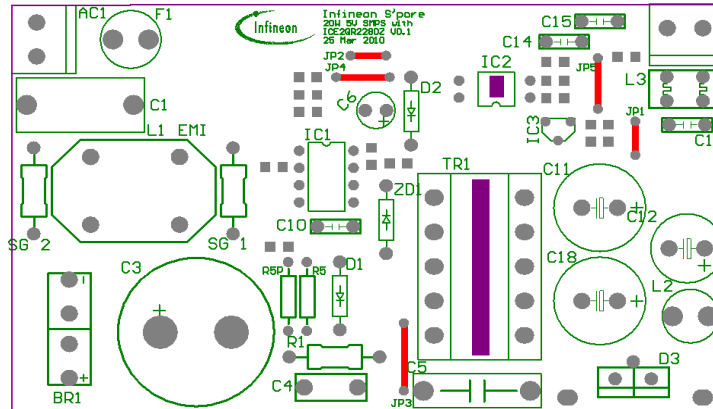

Figure 3 –Component Legend – View from topside

8.2 PCB Bottom Layer

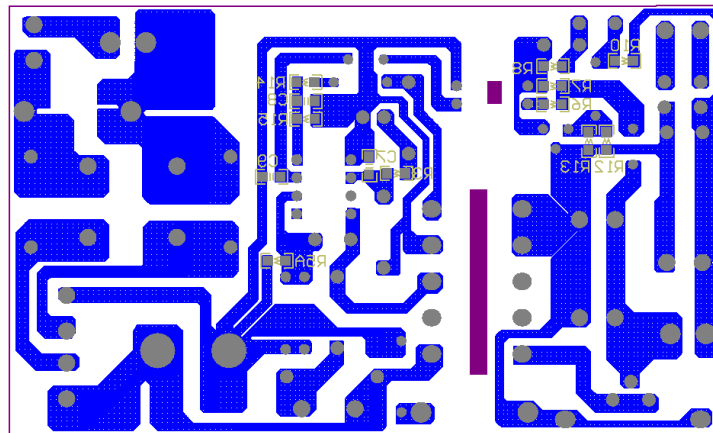

Figure 4 Solder side copper – View from bottom side

9 Component List

Items	Designator	Descriptions	Part No.	Manufacturer
1	F1	Fuse	1.6A	
2	L1	Com-Choke	2x47mH, 0.4A	Epcos
3	BR1	Bridge Rectifier	2KBB80R	
4	ZD1	Zener Diode	22V	
5	D1	Ultra Fast Diode	UF4005	
6	D2	Diode	1N486B	
7	D3	45V Schottky Diode	STPS30L45CT	
8	IC1	800V QR Coolset	ICE2Q2280Z	Infineon
9	IC2	Optp-coupler	SFH617A-3	
10	IC3	2.5 Reference	TL431	
11	C1	0.22uF / 275V X Cap	B32922 X2 MKP/SH	Epcos
12	C3	68uF / 400V Bulk Cap	B43501A9686M00	Epcos
13	C4	2.2nF / 630V	MKP 2.2nF / 630V	Epcos
14	C5	2.2nF/ 250V, Y Cap	2.2nF/ 250V, Y1	
15	C6	33uF / 35V	33uF / 35V	
16	C7	0.1uF SMD	0.1uF SMD	
17	C8	100pF SMD	100pF SMD	
18	C9	1nF SMD	1nF SMD	
19	C10	47pF / 1kV	47pF / 1kV	
20	C11	2200uF / 25V, 105°C, low ESR, 12.5x25 mm	2200uF / 25V	
21	C12	220uF / 25V, 105°C, low ESR, 10x13 mm	220uF / 25V	
22	C14	1nF	1nF	
23	C15	1uF	1uF	
24	C17	0.1uF / 50V	0.1uF / 50V	
25	C18	2200uF / 25V, 105°C, low ESR, 12.5x25 mm	2200uF / 25V	
26	R1	150K / 2W	150K / 2W	
27	R3	200 SMD	200 SMD	
28	R5	2.4R / 1W	2.4R / 1W	
29	R5P	2.4R / 1W	2.4R / 1W	
30	R5A	3.3R / 1W	3.3R / 1W	
31	R6	470 SMD	470 SMD	
32	R7	1.2K SMD	1.2K SMD	
33	R8	6.8K SMD	6.8K SMD	
34	R10	22K SMD	22K SMD	
35	R12	22K SMD	22K SMD	
36	R13	OPEN	OPEN	
37	R14	39K SMD	39K SMD	
38	R15	6.82K SMD	6.82K SMD	
39	L2	1.5uH	1.5uH	

Table 1– Component List

10 Transformer Construction

Core and material :EPCOS(N87)or TDK PC40 EF25/13/7

Bobbin: Vertical Version

Primary Inductance, $L_p=829\mu H(\pm 3\%)$, measured between pin 3 and pin 5 (Gapped to Inductance)

Air Gap in center leg

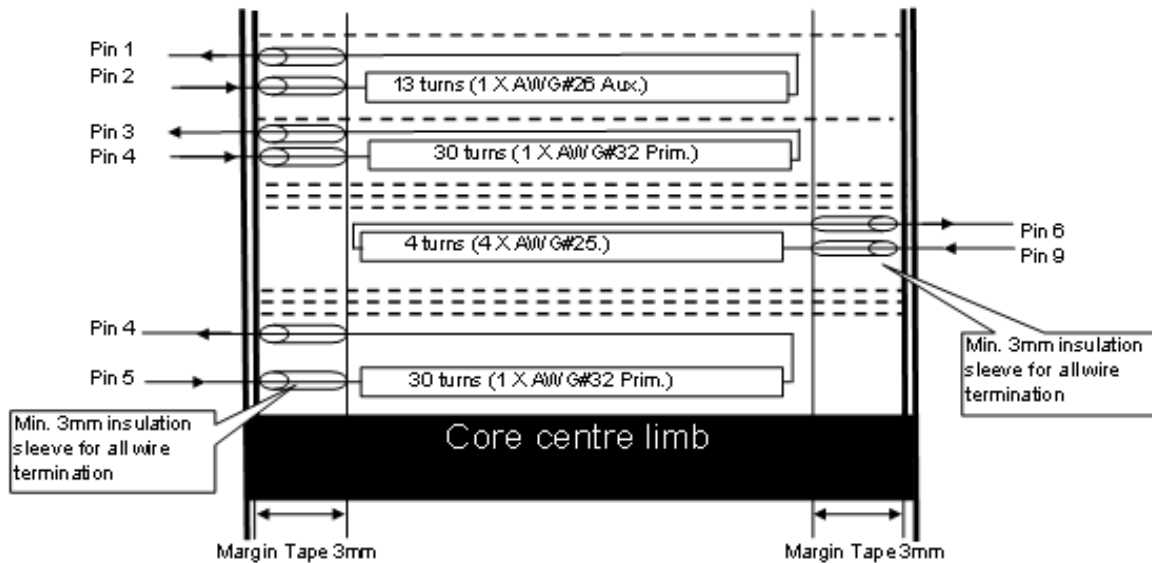

Figure 5 – Transformer structure

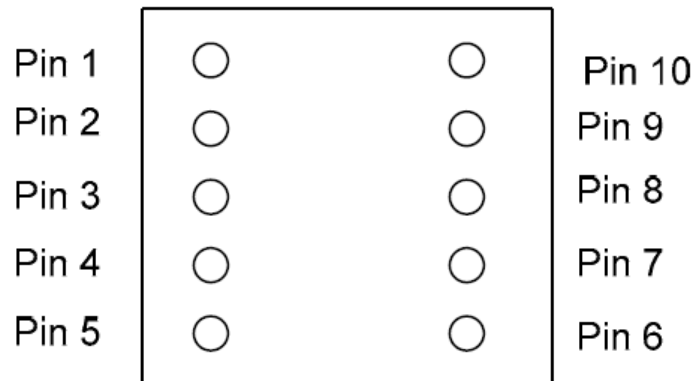

Figure 6 – Transformer complete – top view

Start	Stop	No. of turns	Wire size	Layer
2	1	13	1XAWG#26	Auxiliary
4	3	30	1XAWG#32	$\frac{1}{2}$ Primary
9	6	4	4XAWG#25	Secondary
5	4	30	1XAWG#32	$\frac{1}{2}$ Primary

Table 2 wire gauge used of the transformer windings

11 Test Results

11.1 Efficiency and standby performance

Table 3 – Efficiency vs. Load

Vin (Vac)	Pin (W)	Vo(Vdc)	Io(A)	Po(W)	η (%)	Avg η (%)
85	6.17	5.01	0.9975	4.997475	80.9964	78.8153
	12.57	5.004	2.0025	10.02051	79.7177	
	19.1	4.997	3.0075	15.02848	78.6831	
	26.38	4.99	4.0106	20.01289	75.8639	
115	6.09	5.01	0.9975	4.997475	82.0603	81.8053
	12.04	5.003	2.0025	10.01851	83.2102	
	18.35	4.997	3.0075	15.02848	81.8991	
	25	4.99	4.0106	20.01289	80.0516	
150	6.08	5.01	0.9975	4.997475	82.1953	82.4142
	12.05	5.003	2.0025	10.01851	83.1411	
	18.15	4.997	3.0075	15.02848	82.8015	
	24.55	4.99	4.0106	20.01289	81.5189	
180	5.89	5.01	0.9975	4.997475	84.8468	83.4337
	12.06	5.003	2.0025	10.01851	83.0722	
	18	4.996	3.0075	15.02547	83.4748	
	24.3	4.989	4.0106	20.00888	82.3411	
230	6.25	5.01	0.9975	4.997475	79.9596	82.2564
	12.05	5.003	2.0025	10.01851	83.1411	
	18.05	4.996	3.0075	15.02547	83.2436	
	24.2	4.989	4.0106	20.00888	82.6813	
282	6.43	5.01	0.9975	4.997475	77.7212	80.9038
	12.3	5.004	2.0025	10.02051	81.4676	
	18.35	4.997	3.0075	15.02848	81.8991	
	24.25	4.99	4.0106	20.01289	82.5274	

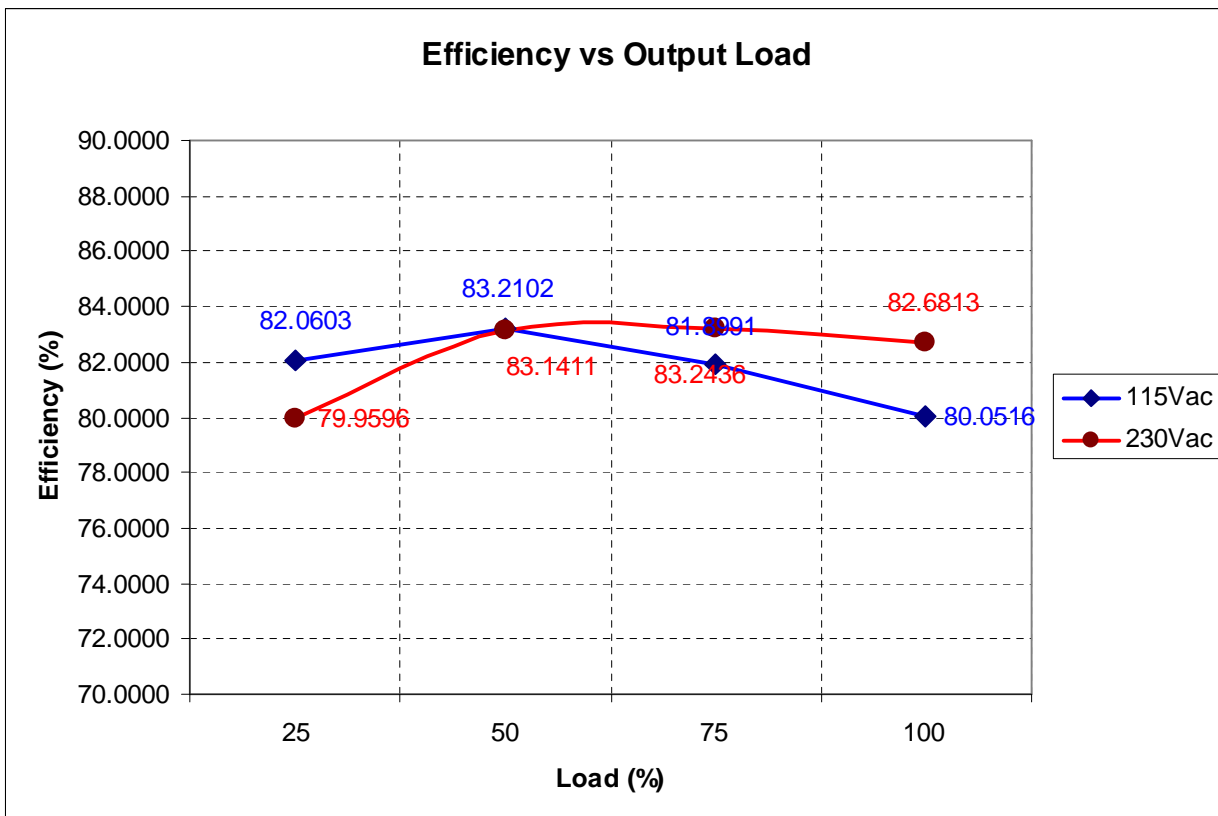
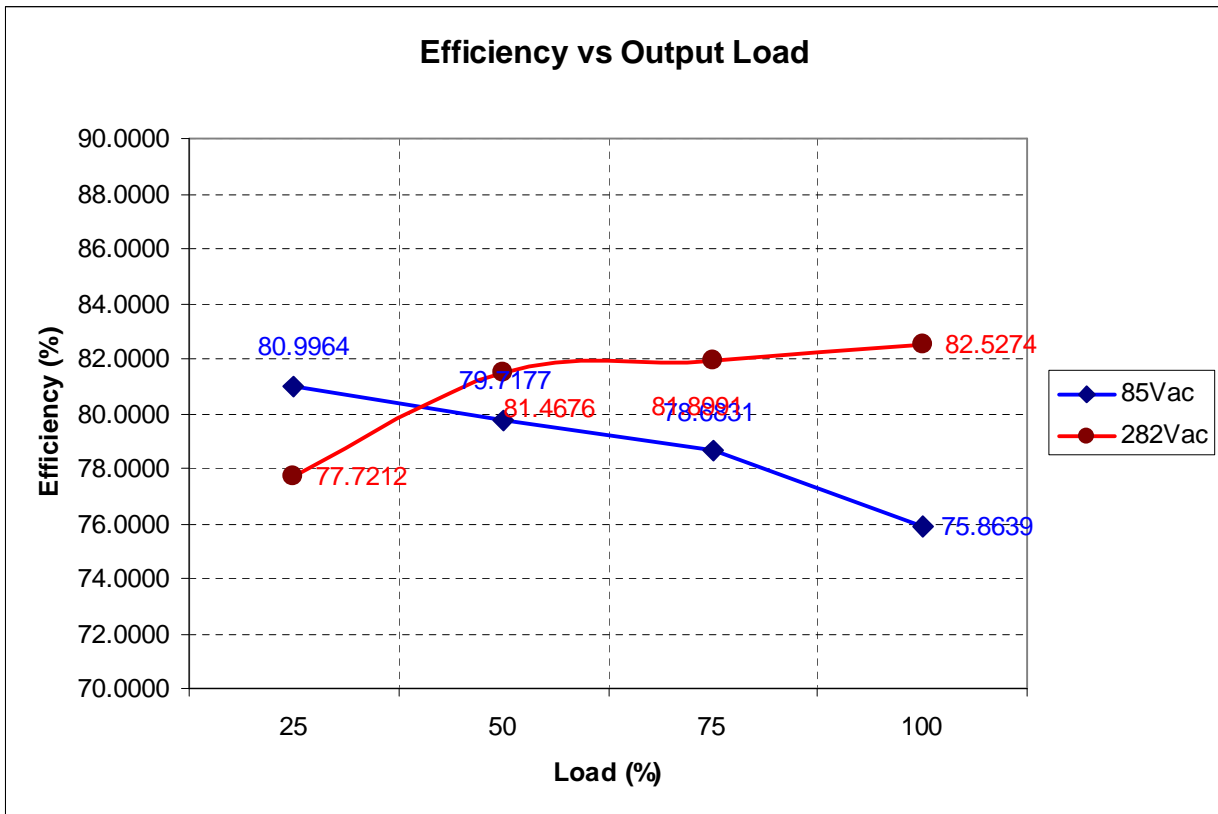

Figure 7 – Efficiency vs. Output Load

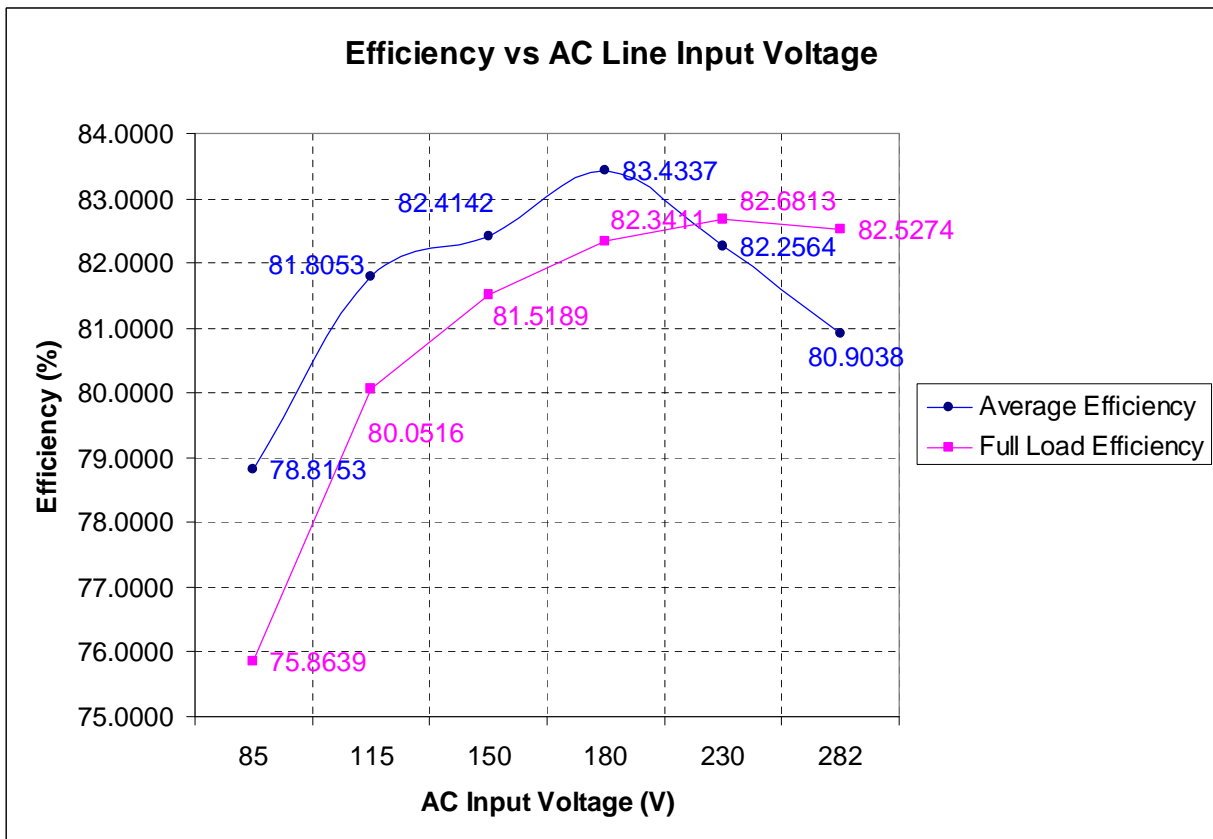

Figure 8 Efficiency vs AC line voltage

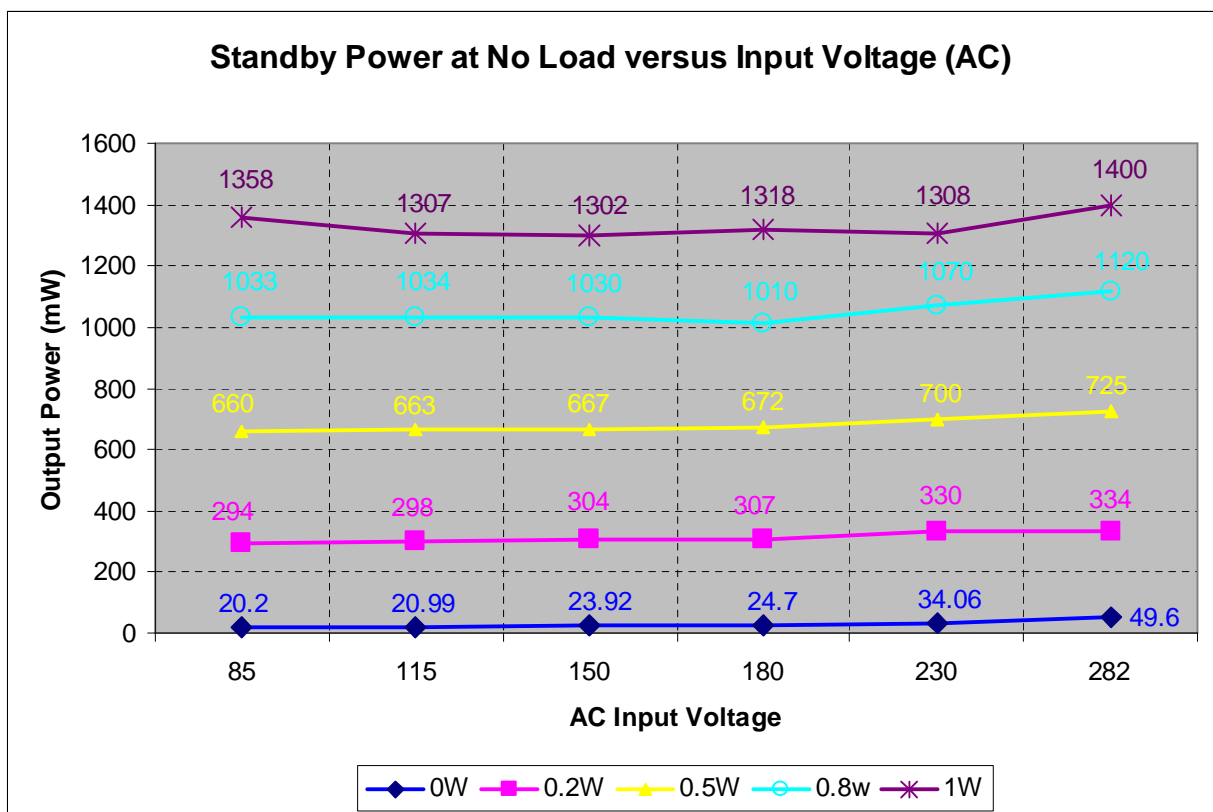

Figure 9 Standby input power vs AC line voltage

12 Waveforms and scope plots

12.1 Startup at 85Vac and 20W load

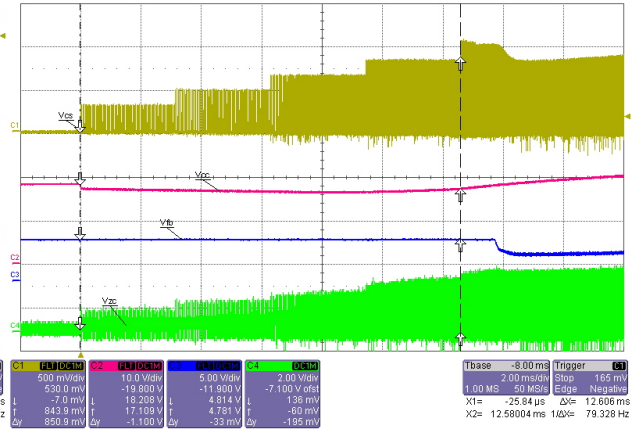
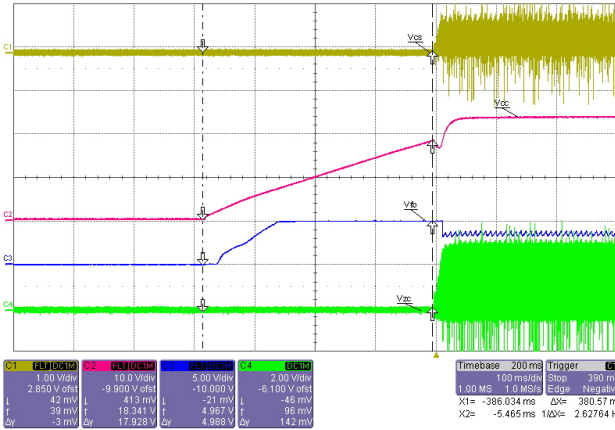

Figure 10 Constant Charging VCC @ startup

Ch1 Current Sense Voltage, VCS
 Ch2 VCC Supply Voltage
 Ch3 Feedback Voltage, VFB
 Ch4 Zero Crossing Voltage, VZC
 Test Condition: 85Vac input, 4A Load

Figure 11 Four steps softstarts

Ch1 Current Sense Voltage, VCS
 Ch2 VCC Supply Voltage
 Ch3 Feedback Voltage, VFB
 Ch4 Zero Crossing Voltage, VZC
 Test Condition: 85Vac input, 4A Load

12.2 Zero Crossing Points during normal operation

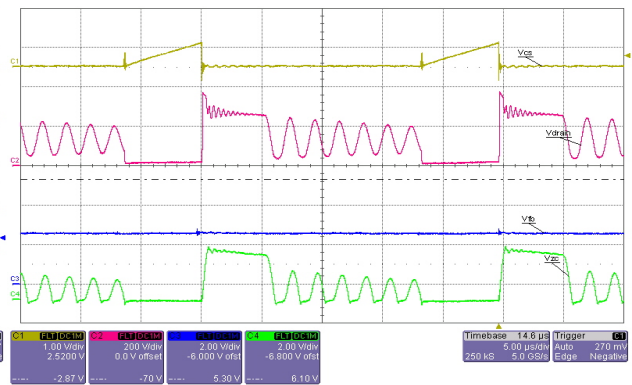
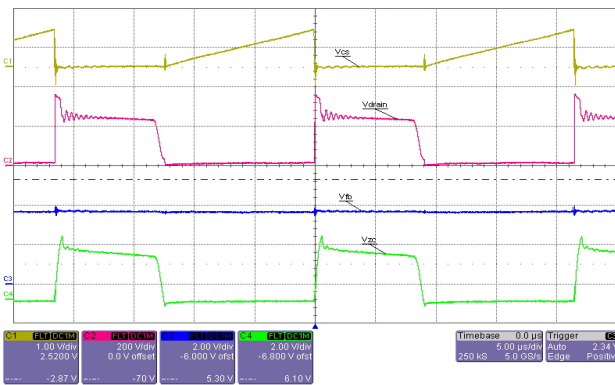

Figure 12 Working at the 1st Zero Crossing

Ch1 Current Sense Voltage, VCS
 Ch2 Drain Voltage
 Ch3 Feedback Voltage, VFB
 Ch4 Zero Crossing Voltage, VZC
 Test Condition: 85Vac input

Figure 13 Working at the 2nd Zero Crossing

Ch1 Current Sense Voltage, VCS
 Ch2 Drain Voltage
 Ch3 Feedback Voltage, VFB
 Ch4 Zero Crossing Voltage, VZC
 Test Condition: 85Vac input

12.3 Load Transient Response

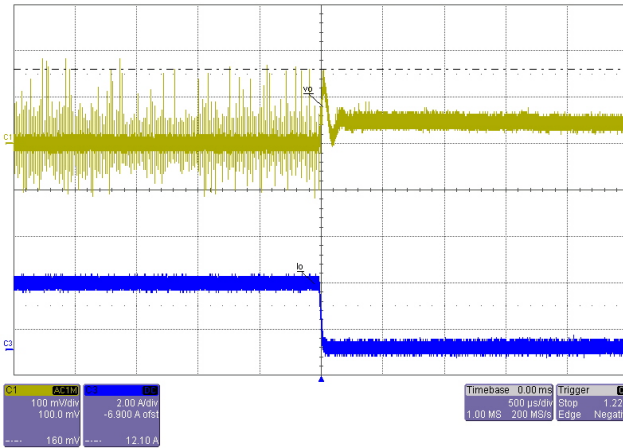

Figure 14 AC output ripple overshoot
 Ch1 Output Current, Iout
 Ch2 Feedback Voltage, VFB
 Test Condition: Load 3A to 0A
 Measured with decouple capacitor 0.1uF, and 10uF

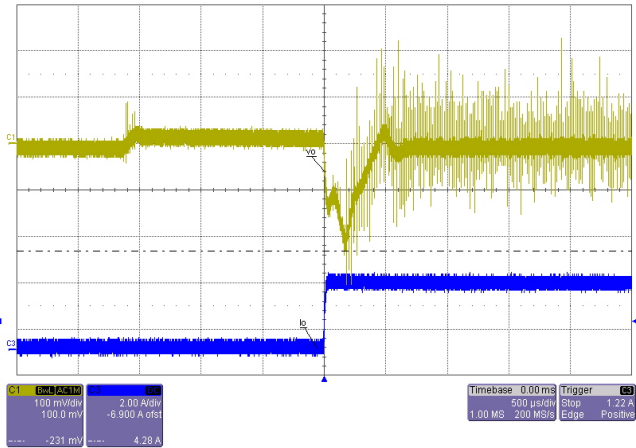

Figure 15 AC output ripple undershoot
 Ch1 Output Current, Iout
 Ch2 Feedback Voltage, VFB
 Test Condition: Load 0A to 3A
 Measured with decouple capacitor 0.1uF, and 10uF

12.4 Burst Mode Operation

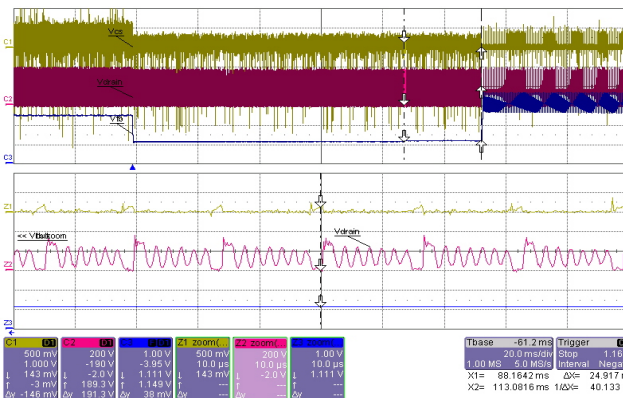

Figure 16 Entering Burst Mode Operation
 Ch1 Current Sense Voltage, VCS
 Ch2 Drain Voltage
 Ch3 Feedback Voltage, VFB
 Test Condition: 85Vac, Load changed fr. 6th ZC to 0.2A

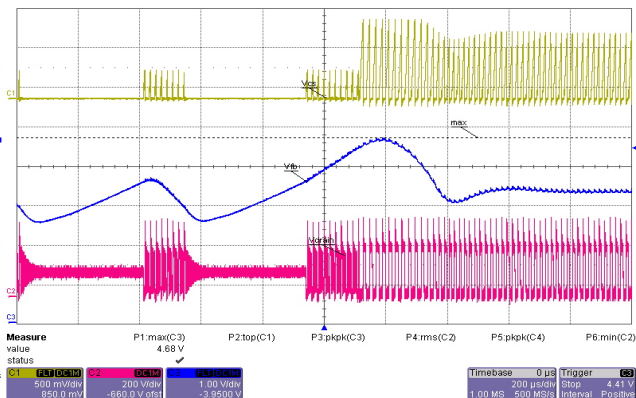

Figure 17 Leaving Burst Mode Operation
 Ch1 Current Sense Voltage, VCS
 Ch2 Drain Voltage
 Ch3 Feedback Voltage, VFB
 Test Condition: Load changed fr. 6th ZC to 0.2A

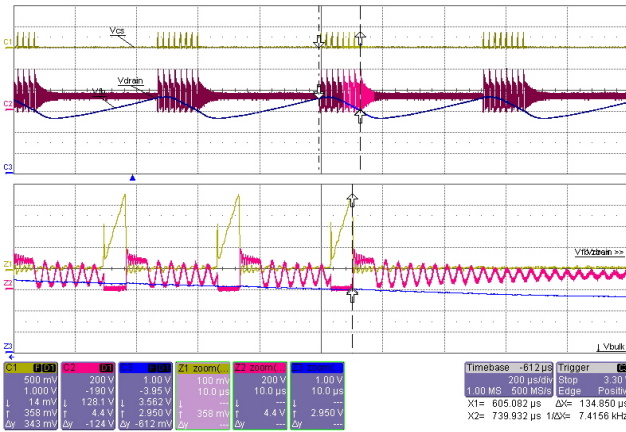

Figure 18 Active Burst Mode Operation
 Ch1 Current Sense Voltage, VCS
 Ch2 Drain Voltage
 Ch3 Feedback Voltage, VFB
 Test Condition: 85Vac, under BMO

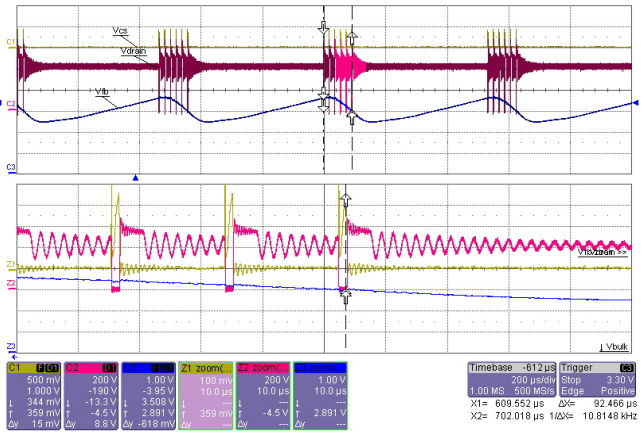

Figure 19 Active Burst Mode Operation
 Ch1 Current Sense Voltage, VCS
 Ch2 Drain Voltage
 Ch3 Feedback Voltage, VFB
 Test Condition: 282Vac, under BMO

12.5 Protection modes

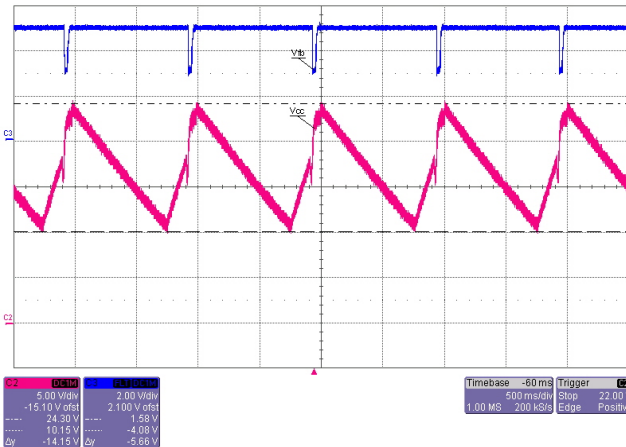

Figure 20 VCC Over-voltage Protection
 Ch2 VCC Supply Voltage
 Ch3 Feedback Voltage, VFB
 Test Condition: open the zener clamping with overload at high-line

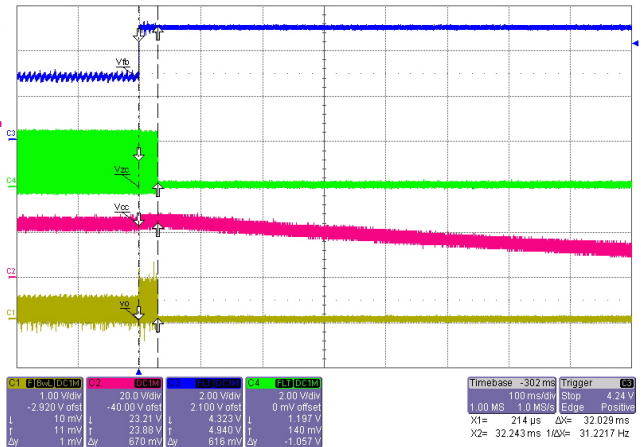

Figure 21 Over Load/ Open Loop Protection
 Ch1 Output Voltage, Vo
 Ch2 VCC Supply Voltage
 Ch3 Feedback Voltage, VFB
 Ch4 Zero Crossing Voltage, VZC
 Test Condition: Load change from 1A to 5A

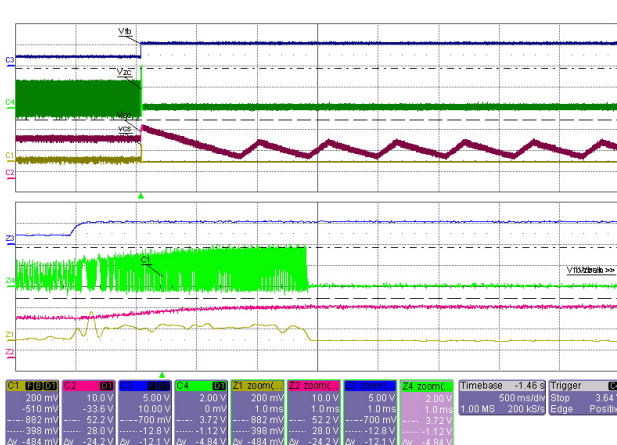

Figure 22 Output Over-voltage Protection

Ch1 Current Sense Voltage, VCS

Ch2 VCC Supply Voltage

Ch3 Feedback Voltage, VFB

Ch4 Zero Crossing Voltage. VZC

Test Condition: change the ZC resistor divider ratio,
Apply 230Vac, Load 1A

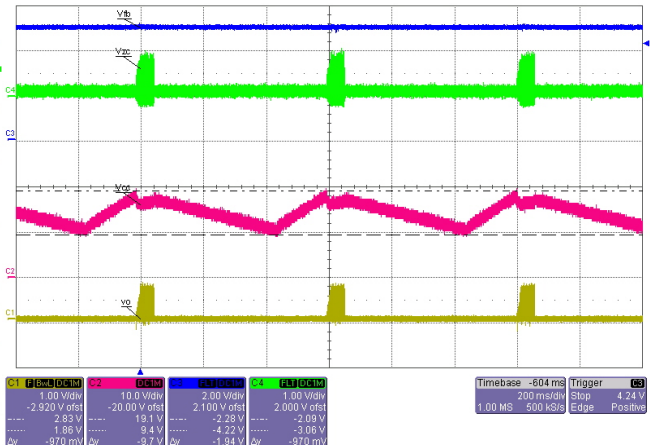

Figure 23 Output Short Circuit Protection

Ch1 Output Voltage, Vo

Ch2 VCC Supply Voltage

Ch3 Feedback Voltage, VFB

Ch4 Zero Crossing Voltage. VZC

Test Condition: Shorted output terminal

13 References

- [1] ICE2QR2280Z datasheet, Infineon Technologies AG, 2010
- [2] ICE2Qxx65/80x Quasi Resonance CoolSET Design Guide (ANPS0053), Infineon Technologies AG, 2010
- [3] Design Tips for flyback converters using the Quasi-Resonant (ANPS0005), Infineon Technologies AG, 2006
- [4] Converter Design Using the Quasi-Resonant PWM Controller ICE2QS01 (ANPS0003), Infineon Technologies AG, 2006
- [5] Determine the Switching Frequency of Quasi-Resonant Flyback Converters Designed with ICE2QS01 (ANPS0004), Infineon Technologies AG, 2006