

# 60MHz Rail-to-Rail Input-Output Operational Amplifier

## EL5211T

The EL5211T is a high voltage rail-to-rail input-output amplifier with low power consumption. The EL5211T contains two amplifiers. Each amplifier exhibits beyond the rail input capability, rail-to-rail output capability and is unity gain stable.

The maximum operating voltage range is from 4.5V to 19V. It can be configured for single or dual supply operation, and typically consumes only 3mA per amplifier. The EL5211T has an output short circuit capability of  $\pm 300\text{mA}$  and a continuous output current capability of  $\pm 65\text{mA}$ .

The EL5211T features a high slew rate of  $100\text{V}/\mu\text{s}$ , and fast settling time. Also, the device provides common mode input capability beyond the supply rails, rail-to-rail output capability, and a bandwidth of 60MHz (-3dB). This enables the amplifiers to offer maximum dynamic range at any supply voltage. These features make the EL5211T an ideal amplifier solution for use in TFT-LCD panels as a  $V_{\text{COM}}$  driver or static gamma buffer, and in high speed filtering and signal conditioning applications. Other applications include battery power and portable devices, especially where low power consumption is important.

The EL5211T is available in a thermally enhanced 8 Ld HMSOP package, and a thermally enhanced 8 Ld DFN package. Both feature a standard operational amplifier pinout. The device operates over an ambient temperature range of  $-40^{\circ}\text{C}$  to  $+85^{\circ}\text{C}$ .

## Features

- 60MHz (-3dB) Bandwidth
- 4.5V to 19V Maximum Supply Voltage Range
- $100\text{V}/\mu\text{s}$  Slew Rate
- 3mA Supply Current (per Amplifier)
- $\pm 65\text{mA}$  Continuous Output Current
- $\pm 300\text{mA}$  Output Short Circuit Current
- Unity-gain Stable
- Beyond the Rails Input Capability
- Rail-to-rail Output Swing
- Built-in Thermal Protection
- $-40^{\circ}\text{C}$  to  $+85^{\circ}\text{C}$  Ambient Temperature Range
- Pb-Free (RoHS Compliant)

## Applications\* (see page 13)

- TFT-LCD Panels
- $V_{\text{COM}}$  Amplifiers
- Static Gamma Buffers
- Drivers for A/D Converters
- Data Acquisition
- Video Processing
- Audio Processing
- Active Filters
- Test Equipment
- Battery-powered Applications
- Portable Equipment

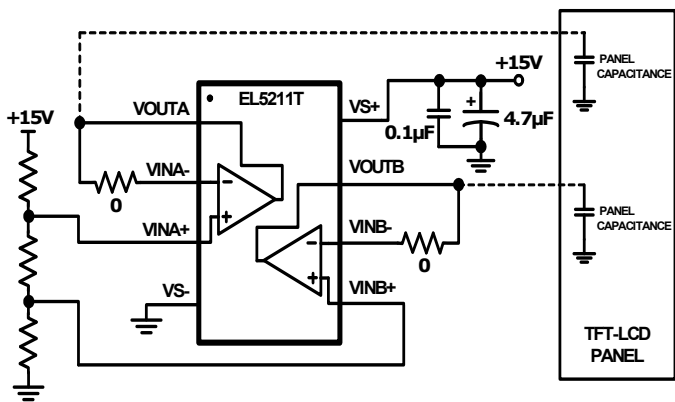

FIGURE 1. TYPICAL TFT-LCD  $V_{\text{COM}}$  APPLICATION

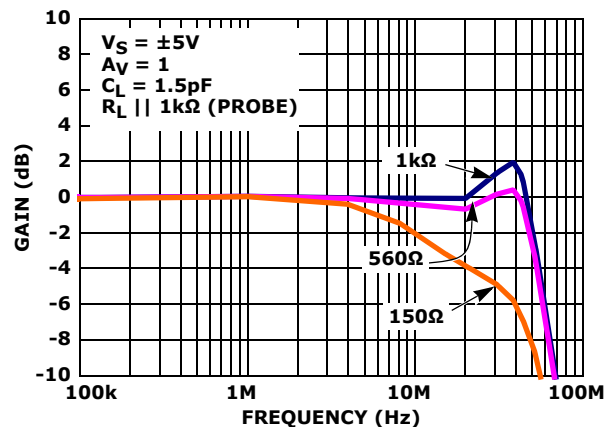
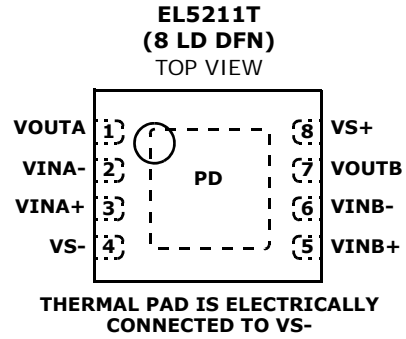
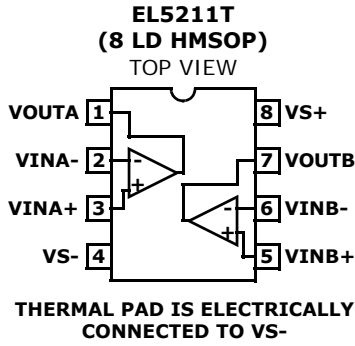

FIGURE 2. FREQUENCY RESPONSE FOR VARIOUS  $R_L$

## Pin Configuration



## Pin Descriptions

PIN NUMBER (HMSOP, DFN)	PIN NAME	FUNCTION	EQUIVALENT CIRCUIT
1	VOUTA	Amplifier A output	(Reference Circuit 1)
2	VINA-	Amplifier A inverting input	(Reference Circuit 2)
3	VINA+	Amplifier A non-inverting input	(Reference Circuit 2)
4	VS-	Negative power supply	
5	VINB+	Amplifier B non-inverting input	(Reference Circuit 2)
6	VINB-	Amplifier B inverting input	(Reference Circuit 2)
7	VOUTB	Amplifier B output	(Reference Circuit 1)
8	VS+	Positive power supply	
Pad	PD	Functions as a heat sink. Electrically connected to VS-. Connect the thermal pad to VS- plane on the PCB for optimum thermal performance.	

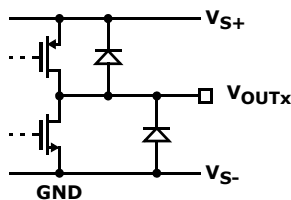

**CIRCUIT 1**

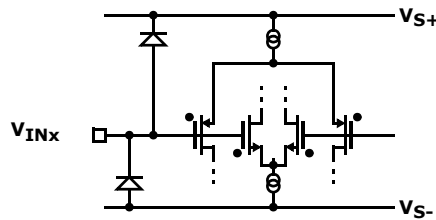

**CIRCUIT 2**

## Ordering Information

PART NUMBER (Notes 2, 3)	PART MARKING	PACKAGE (Pb-Free)	PKG. DWG. #
EL5211TILZ-T13 (Note 1)	11T	8 Ld DFN	L8.2x3
EL5211TIYEZ	BBBNA	8 Ld HMSOP	MDP0050
EL5211TIYEZ-T7 (Note 1)	BBBNA	8 Ld HMSOP	MDP0050
EL5211TIYEZ-T13 (Note 1)	BBBNA	8 Ld HMSOP	MDP0050

### NOTES:

1. Please refer to [TB347](#) for details on reel specifications.
2. These Intersil Pb-free plastic packaged products employ special Pb-free material sets, molding compounds/die attach materials, and 100% matte tin plate plus anneal (e3 termination finish, which is RoHS compliant and compatible with both SnPb and Pb-free soldering operations). Intersil Pb-free products are MSL classified at Pb-free peak reflow temperatures that meet or exceed the Pb-free requirements of IPC/JEDEC J STD-020.
3. For Moisture Sensitivity Level (MSL), please see device information page for [EL5211T](#). For more information on MSL please see techbrief [TB363](#).

# EL5211T

## Absolute Maximum Ratings (T<sub>A</sub> = +25°C)

Supply Voltage between V <sub>S+</sub> and V <sub>S-</sub> . . . . .	+19.8V
Input Voltage Range (V <sub>INx+</sub> , V <sub>INx-</sub> ) . . . . .	V <sub>S-</sub> - 0.5V, V <sub>S+</sub> + 0.5V
Input Differential Voltage (V <sub>INx+</sub> - V <sub>INx-</sub> ) . . . . .	(V <sub>S+</sub> + 0.5V) - (V <sub>S-</sub> - 0.5V)
Maximum Continuous Output Current . . . . .	±65mA
ESD Rating	
Human Body Model . . . . .	3000V

## Thermal Information

Thermal Resistance (Typical)	θ <sub>JA</sub> (°C/W)	θ <sub>JC</sub> (°C/W)
8 Ld HMSOP (Notes 4, 5) . . . . .	62	13
8 Ld DFN (Notes 4, 5) . . . . .	58	8
Storage Temperature . . . . .	-65°C to +150°C	
Ambient Operating Temperature . . . . .	-40°C to +85°C	
Maximum Junction Temperature . . . . .	+150°C	
Power Dissipation . . . . .	See Figures 34 and 35	
Pb-Free Reflow Profile . . . . .	see link below	
<a href="http://www.intersil.com/pbfree/Pb-FreeReflow.asp">http://www.intersil.com/pbfree/Pb-FreeReflow.asp</a>		

**CAUTION:** Do not operate at or near the maximum ratings listed for extended periods of time. Exposure to such conditions may adversely impact product reliability and result in failures not covered by warranty.

### NOTES:

- θ<sub>JA</sub> is measured in free air with the component mounted on a high effective thermal conductivity test board with "direct attach" features. See Tech Brief TB379.
- For θ<sub>JC</sub>, the "case temp" location is the center of the exposed metal pad on the package underside.

**IMPORTANT NOTE:** All parameters having Min/Max specifications are guaranteed. Typ values are for information purposes only. Unless otherwise noted, all tests are at the specified temperature and are pulsed tests, therefore: T<sub>J</sub> = T<sub>C</sub> = T<sub>A</sub>

## Electrical Specifications V<sub>S+</sub> = +5V, V<sub>S-</sub> = -5V, R<sub>L</sub> = 1kΩ to 0V, T<sub>A</sub> = +25°C, Unless Otherwise Specified.

PARAMETER	DESCRIPTION	CONDITIONS	MIN	TYP	MAX	UNIT
<b>INPUT CHARACTERISTICS</b>						
V <sub>OS</sub>	Input Offset Voltage	V <sub>CM</sub> = 0V		5	18	mV
TCV <sub>OS</sub>	Average Offset Voltage Drift (Note 6)	8 Ld HMSOP package		13		μV/°C
		8 Ld DFN package		9		μV/°C
I <sub>B</sub>	Input Bias Current	V <sub>CM</sub> = 0V		2	60	nA
R <sub>IN</sub>	Input Impedance			1		GΩ
C <sub>IN</sub>	Input Capacitance			2		pF
CMIR	Common-Mode Input Range		-5.5		+5.5	V
CMRR	Common-Mode Rejection Ratio	For V <sub>IN</sub> from -5.5V to 5.5V	50	73		dB
A <sub>VOL</sub>	Open-Loop Gain	-4.5V ≤ V <sub>OUTx</sub> ≤ 4.5V	62	78		dB
<b>OUTPUT CHARACTERISTICS</b>						
V <sub>OL</sub>	Output Swing Low	I <sub>L</sub> = -5mA		-4.95	-4.85	V
V <sub>OH</sub>	Output Swing High	I <sub>L</sub> = +5mA	4.85	4.95		V
I <sub>SC</sub>	Short-Circuit Current	V <sub>CM</sub> = 0V, Source: V <sub>OUTx</sub> short to V <sub>S-</sub> , Sink: V <sub>OUTx</sub> short to V <sub>S+</sub>		±300		mA
I <sub>OUT</sub>	Output Current			±65		mA
<b>POWER SUPPLY PERFORMANCE</b>						
(V <sub>S+</sub> ) - (V <sub>S-</sub> )	Supply Voltage Range		4.5		19	V
I <sub>S</sub>	Supply Current	V <sub>CM</sub> = 0V, No load		5.5	7.5	mA
PSRR	Power Supply Rejection Ratio	Supply is moved from ±2.25V to ±9.5V	60	75		dB
<b>DYNAMIC PERFORMANCE</b>						
SR	Slew Rate (Note 7)	-4.0V ≤ V <sub>OUTx</sub> ≤ 4.0V, 20% to 80%		100		V/μs
t <sub>S</sub>	Settling to +0.1% (Note 8)	A <sub>V</sub> = +1, V <sub>OUTx</sub> = 2V step, R <sub>L</sub> = 1kΩ    1kΩ (probe), C <sub>L</sub> = 1.5pF		85		ns
BW	-3dB Bandwidth	R <sub>L</sub> = 1kΩ, C <sub>L</sub> = 1.5pF		60		MHz

# EL5211T

## Electrical Specifications $V_{S+} = +5V$ , $V_{S-} = -5V$ , $R_L = 1k\Omega$ to $0V$ , $T_A = +25^\circ C$ , Unless Otherwise Specified. (Continued)

PARAMETER	DESCRIPTION	CONDITIONS	MIN	TYP	MAX	UNIT
GBWP	Gain-Bandwidth Product	$A_V = -10$ , $R_F = 1k\Omega$ , $R_G = 100\Omega$ $R_L = 1k\Omega \parallel 1k\Omega$ (probe), $C_L = 1.5pF$		32		MHz
PM	Phase Margin	$A_V = -10$ , $R_F = 1k\Omega$ , $R_G = 100\Omega$ $R_L = 1k\Omega \parallel 1k\Omega$ (probe), $C_L = 1.5pF$		50		°
CS	Channel Separation	$f = 5MHz$		90		dB

## Electrical Specifications $V_{S+} = +5V$ , $V_{S-} = 0V$ , $R_L = 1k\Omega$ to $2.5V$ , $T_A = +25^\circ C$ , Unless Otherwise Specified.

PARAMETER	DESCRIPTION	CONDITION	MIN	TYP	MAX	UNIT
<b>INPUT CHARACTERISTICS</b>						
$V_{OS}$	Input Offset Voltage	$V_{CM} = 2.5V$		5	18	mV
$TCV_{OS}$	Average Offset Voltage Drift (Note 6)	8 Ld HMSOP package		11		$\mu V/^\circ C$
		8 Ld DFN package		8		$\mu V/^\circ C$
$I_B$	Input Bias Current	$V_{CM} = 2.5V$		2	60	nA
$R_{IN}$	Input Impedance			1		$G\Omega$
$C_{IN}$	Input Capacitance			2		pF
CMIR	Common-Mode Input Range		-0.5		+5.5	V
CMRR	Common-Mode Rejection Ratio	For $V_{IN}$ from -0.5V to 5.5V	45	68		dB
$A_{VOL}$	Open-Loop Gain	$0.5V \leq V_{OUTx} \leq 4.5V$	62	82		dB
<b>OUTPUT CHARACTERISTICS</b>						
$V_{OL}$	Output Swing Low	$I_L = -4.2mA$		60	150	mV
$V_{OH}$	Output Swing High	$I_L = +4.2mA$	4.85	4.94		V
$I_{SC}$	Short-circuit Current	$V_{CM} = 2.5V$ , Source: $V_{OUTx}$ short to $V_{S-}$ , Sink: $V_{OUTx}$ short to $V_{S+}$		$\pm 110$		mA
$I_{OUT}$	Output Current			$\pm 65$		mA
<b>POWER SUPPLY PERFORMANCE</b>						
$(V_{S+}) - (V_{S-})$	Supply Voltage Range		4.5		19	V
$I_S$	Supply Current	$V_{CM} = 2.5V$ , No load		6.0	7.5	mA
PSRR	Power Supply Rejection Ratio	Supply is moved from 4.5V to 19V	60	75		dB
<b>DYNAMIC PERFORMANCE</b>						
SR	Slew Rate (Note 7)	$1V \leq V_{OUTx} \leq 4V$ , 20% to 80%		75		$V/\mu s$
$t_S$	Settling to +0.1% (Note 8)	$A_V = +1$ , $V_{OUTx} = 2V$ step, $R_L = 1k\Omega \parallel 1k\Omega$ (probe), $C_L = 1.5pF$		90		ns
BW	-3dB Bandwidth	$R_L = 1k\Omega$ , $C_L = 1.5pF$		60		MHz
GBWP	Gain-Bandwidth Product	$A_V = -10$ , $R_F = 1k\Omega$ , $R_G = 100\Omega$ $R_L = 1k\Omega \parallel 1k\Omega$ (probe), $C_L = 1.5pF$		32		MHz
PM	Phase Margin	$A_V = -10$ , $R_F = 1k\Omega$ , $R_G = 100\Omega$ $R_L = 1k\Omega \parallel 1k\Omega$ (probe), $C_L = 1.5pF$		50		°
CS	Channel Separation	$f = 5MHz$		90		dB

# EL5211T

**Electrical Specifications**  $V_{S+} = +18V$ ,  $V_{S-} = 0V$ ,  $R_L = 1k\Omega$  to  $9V$ ,  $T_A = +25^\circ C$ , Unless Otherwise Specified.

PARAMETER	DESCRIPTION	CONDITION	MIN	TYP	MAX	UNIT
<b>INPUT CHARACTERISTICS</b>						
$V_{OS}$	Input Offset Voltage	$V_{CM} = 9V$		7	18	mV
$TCV_{OS}$	Average Offset Voltage Drift (Note 6)	8 Ld HMSOP package		14		$\mu V/^\circ C$
		8 Ld DFN package		11		$\mu V/^\circ C$
$I_B$	Input Bias Current	$V_{CM} = 9V$		2	60	nA
$R_{IN}$	Input Impedance			1		G $\Omega$
$C_{IN}$	Input Capacitance			2		pF
CMIR	Common-Mode Input Range		-0.5		+18.5	V
CMRR	Common-Mode Rejection Ratio	For $V_{IN}$ from -0.5V to 18.5V	53	75		dB
$A_{VOL}$	Open-Loop Gain	$0.5V \leq V_{OUTX} \leq 17.5V$	62	104		dB
<b>OUTPUT CHARACTERISTICS</b>						
$V_{OL}$	Output Swing Low	$I_L = -6mA$		80	150	mV
$V_{OH}$	Output Swing High	$I_L = +6mA$	17.85	17.92		V
$I_{SC}$	Short-circuit Current	$V_{CM} = 9V$ , Source: $V_{OUTX}$ short to $V_{S-}$ , Sink: $V_{OUTX}$ short to $V_{S+}$		$\pm 300$		mA
$I_{OUT}$	Output Current			$\pm 65$		mA
<b>POWER SUPPLY PERFORMANCE</b>						
$(V_{S+}) - (V_{S-})$	Supply Voltage Range		4.5		19	V
$I_S$	Supply Current	$V_{CM} = 9V$ , No load		6.0	7.5	mA
PSRR	Power Supply Rejection Ratio	Supply is moved from 4.5V to 19V	60	75		dB
<b>DYNAMIC PERFORMANCE</b>						
SR	Slew Rate (Note 7)	$1V \leq V_{OUTX} \leq 17V$ , 20% to 80%		100		V/ $\mu s$
$t_s$	Settling to +0.1% (Note 8)	$A_V = +1$ , $V_{OUTX} = 2V$ step, $R_L = 1k\Omega \parallel 1k\Omega$ (probe), $C_L = 1.5pF$		100		ns
BW	-3dB Bandwidth	$R_L = 1k\Omega$ , $C_L = 1.5pF$		60		MHz
GBWP	Gain-Bandwidth Product	$A_V = -10$ , $R_F = 1k\Omega$ , $R_G = 100\Omega$ , $R_L = 1k\Omega \parallel 1k\Omega$ (probe), $C_L = 1.5pF$		32		MHz
PM	Phase Margin	$A_V = -10$ , $R_F = 1k\Omega$ , $R_G = 100\Omega$ , $R_L = 1k\Omega \parallel 1k\Omega$ (probe), $C_L = 1.5pF$		50		$^\circ$
CS	Channel Separation	$f = 5MHz$		90		dB

**NOTES:**

6. Measured over  $-40^\circ C$  to  $+85^\circ C$  ambient operating temperature range. See the typical  $TCV_{OS}$  production distribution shown in the "Typical Performance Curves" on page 6.
7. Typical slew rate is an average of the slew rates measured on the rising (20% to 80%) and the falling (80% to 20%) edges of the output signal.
8. Settling time measured as the time from when the output level crosses the final value on rising/falling edge to when the output level settles within a  $\pm 0.1\%$  error band. The range of the error band is determined by: Final Value(V)  $\pm$  [Full Scale(V) \* 0.1%].

## Typical Performance Curves

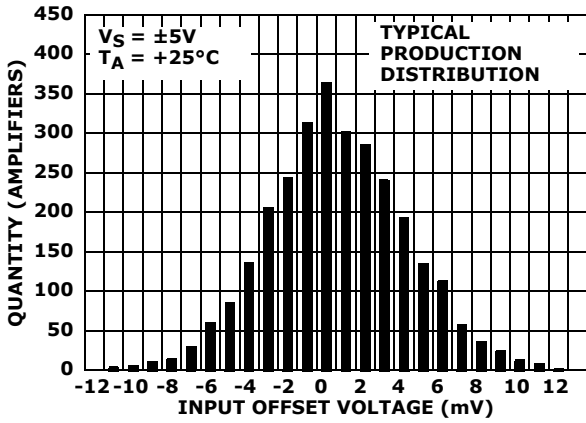

FIGURE 3. INPUT OFFSET VOLTAGE DISTRIBUTION

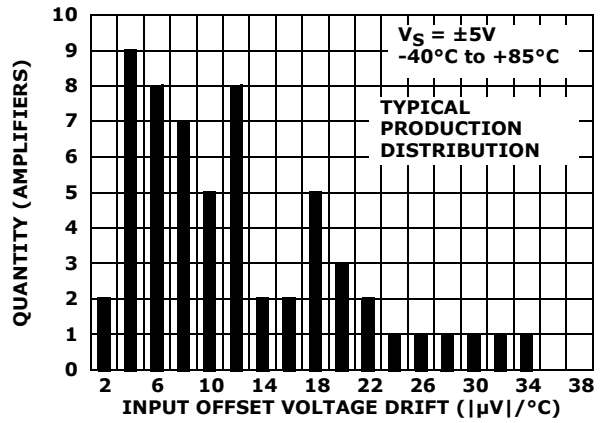

FIGURE 4. INPUT OFFSET VOLTAGE DRIFT (HMSOP)

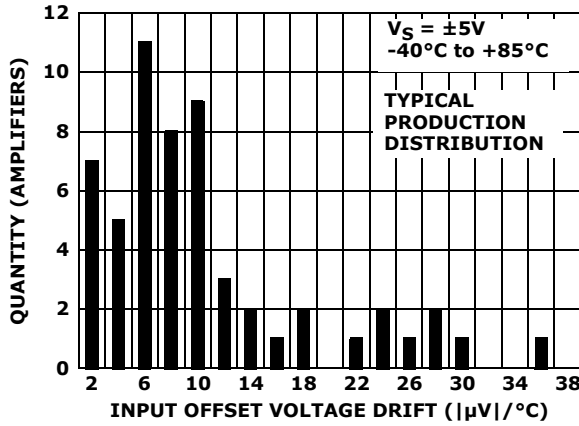

FIGURE 5. INPUT OFFSET VOLTAGE DRIFT (DFN)

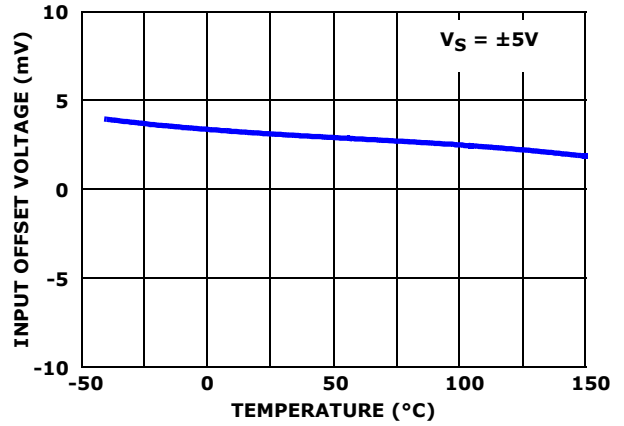

FIGURE 6. INPUT OFFSET VOLTAGE vs TEMPERATURE

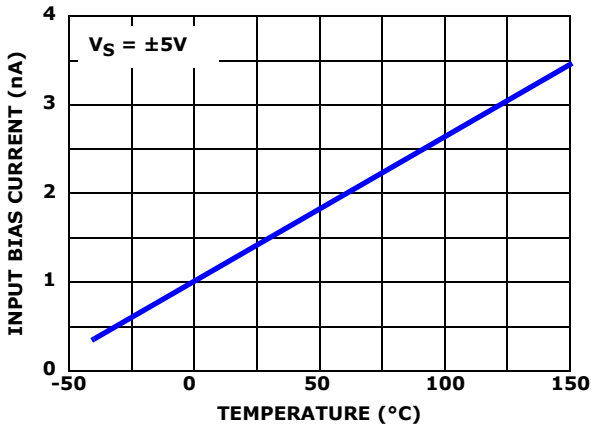

FIGURE 7. INPUT BIAS CURRENT vs TEMPERATURE

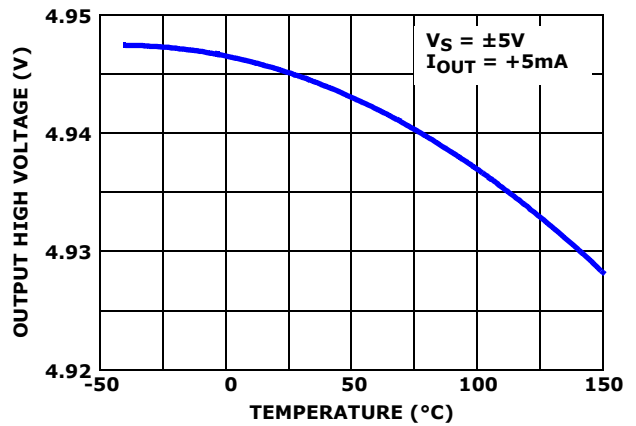

FIGURE 8. OUTPUT HIGH VOLTAGE vs TEMPERATURE

Typical Performance Curves (Continued)

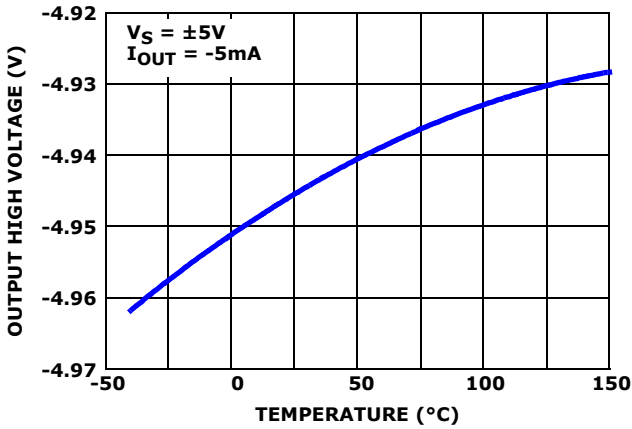

FIGURE 9. OUTPUT LOW VOLTAGE vs TEMPERATURE

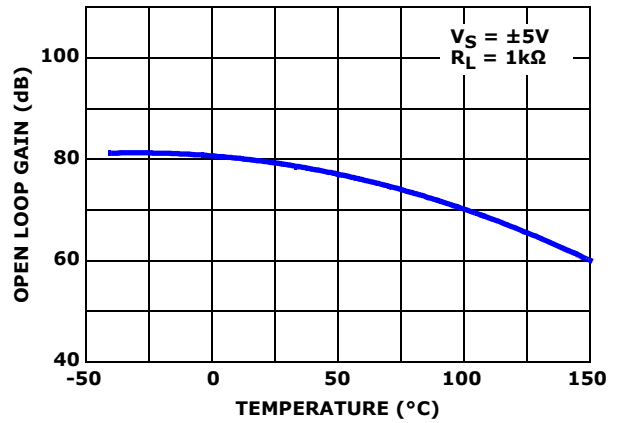

FIGURE 10. OPEN-LOOP GAIN vs TEMPERATURE

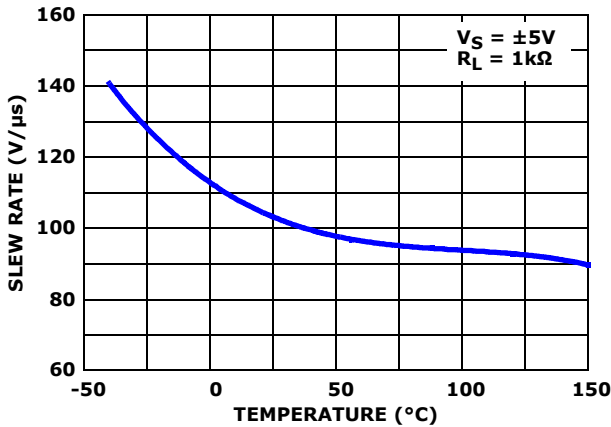

FIGURE 11. SLEW RATE vs TEMPERATURE

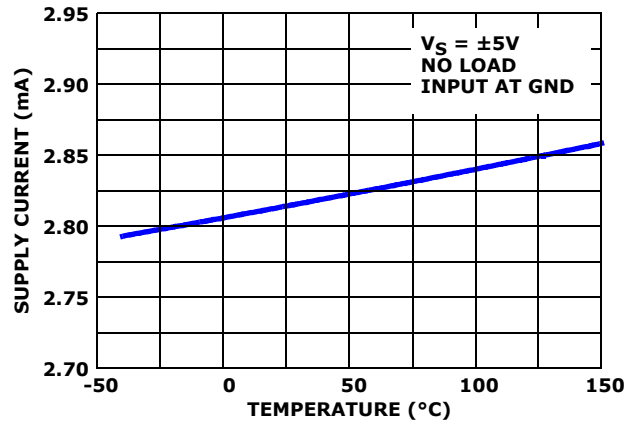

FIGURE 12. SUPPLY CURRENT PER AMPLIFIER vs TEMPERATURE

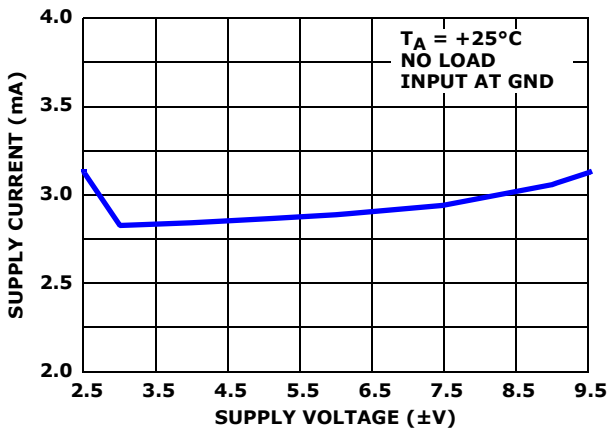

FIGURE 13. SUPPLY CURRENT PER AMPLIFIER vs SUPPLY VOLTAGE

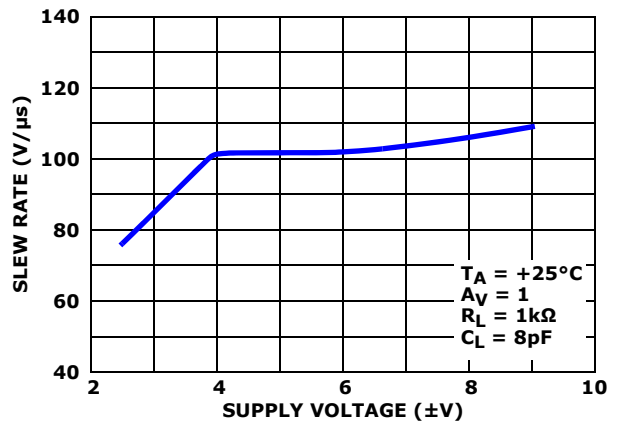

FIGURE 14. SLEW RATE vs SUPPLY VOLTAGE

Typical Performance Curves (Continued)

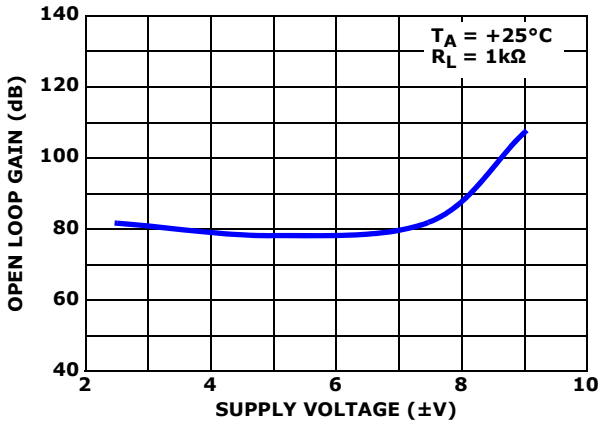

FIGURE 15. OPEN LOOP GAIN vs SUPPLY VOLTAGE

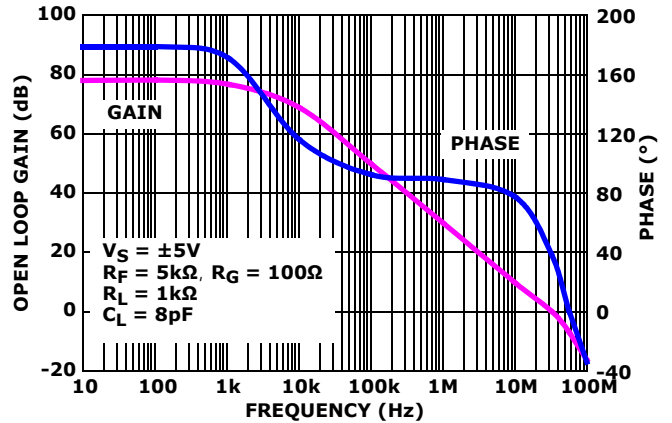

FIGURE 16. OPEN LOOP GAIN AND PHASE

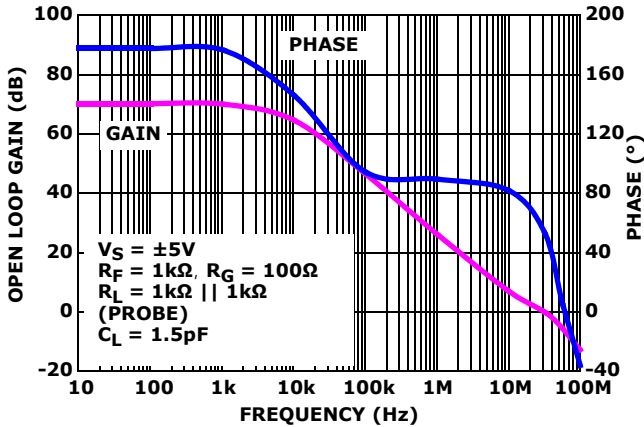

FIGURE 17. OPEN LOOP GAIN AND PHASE

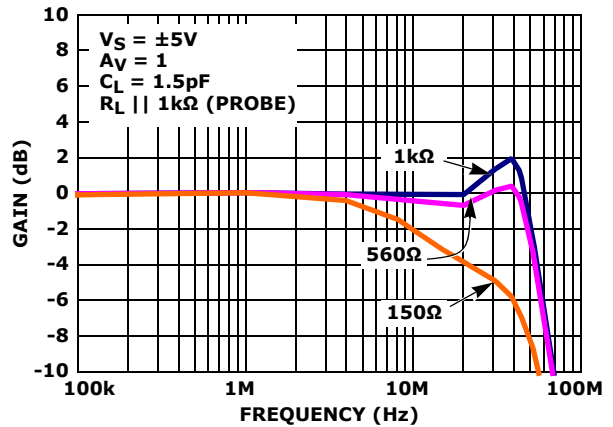

FIGURE 18. FREQUENCY RESPONSE FOR VARIOUS  $R_L$

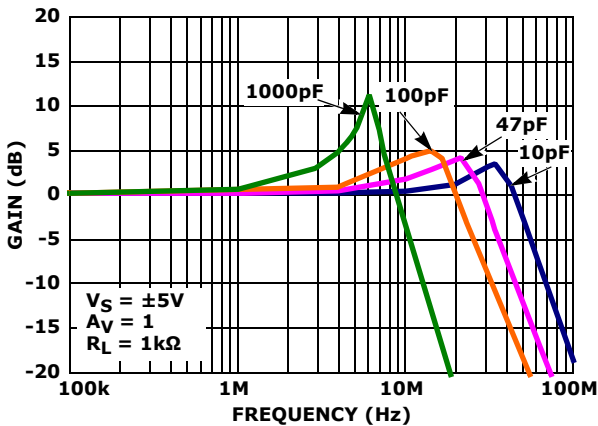

FIGURE 19. FREQUENCY RESPONSE FOR VARIOUS  $C_L$

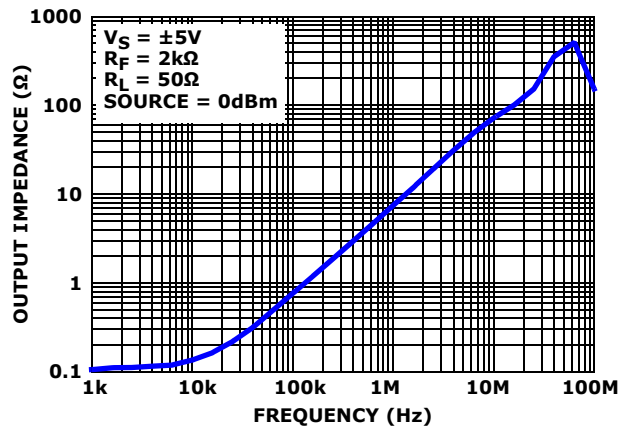

FIGURE 20. CLOSED LOOP OUTPUT IMPEDANCE



Typical Performance Curves (Continued)

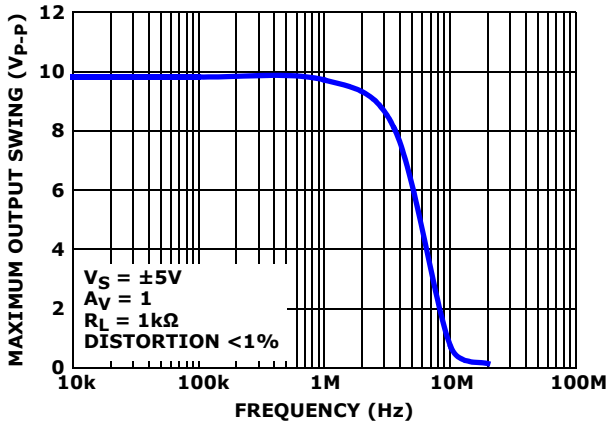

FIGURE 21. MAXIMUM OUTPUT SWING vs FREQUENCY

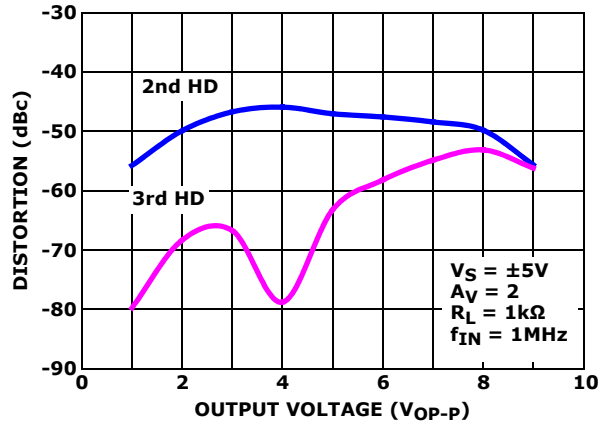

FIGURE 22. HARMONIC DISTORTION vs  $V_{OP-P}$

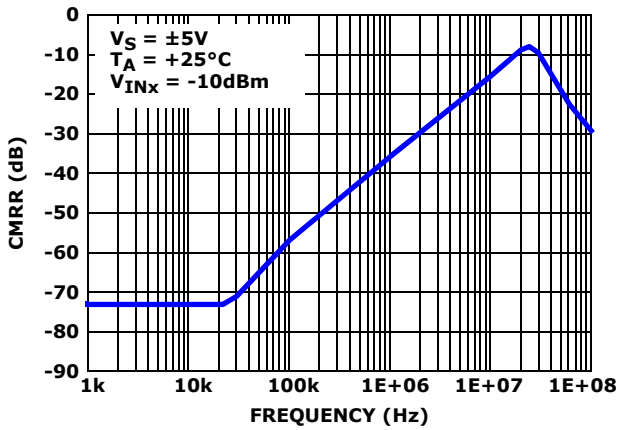

FIGURE 23. CMRR

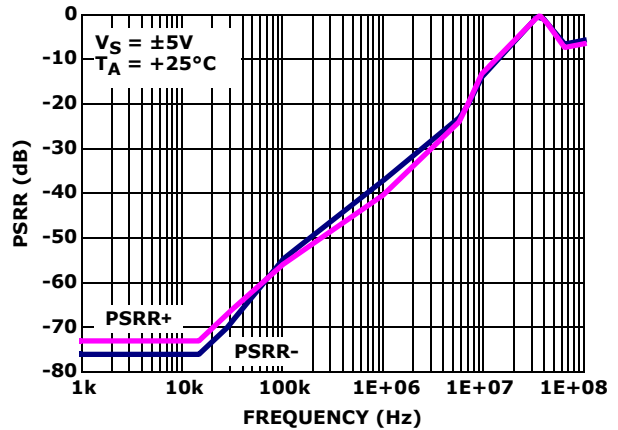

FIGURE 24. PSRR

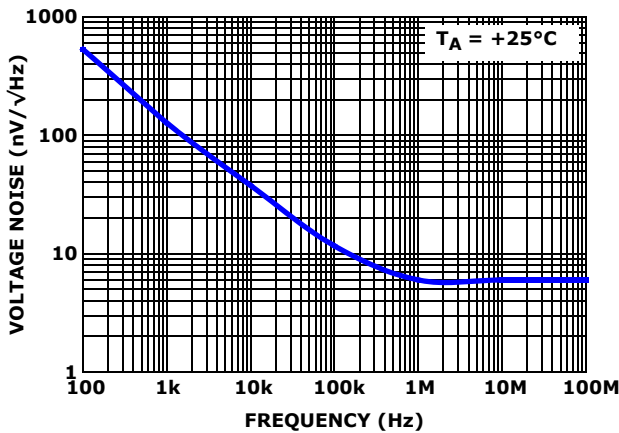

FIGURE 25. INPUT VOLTAGE NOISE SPECTRAL DENSITY

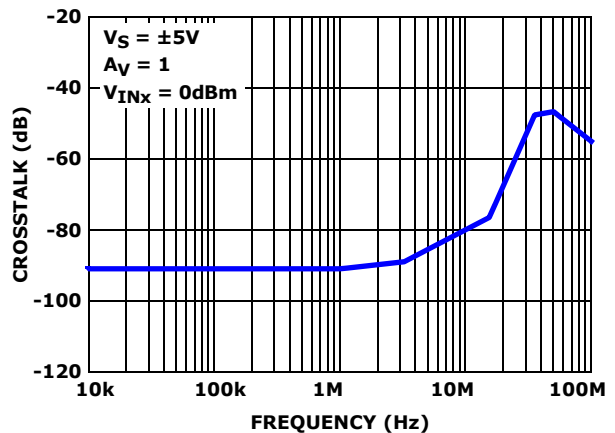

FIGURE 26. CHANNEL SEPARATION

Typical Performance Curves (Continued)

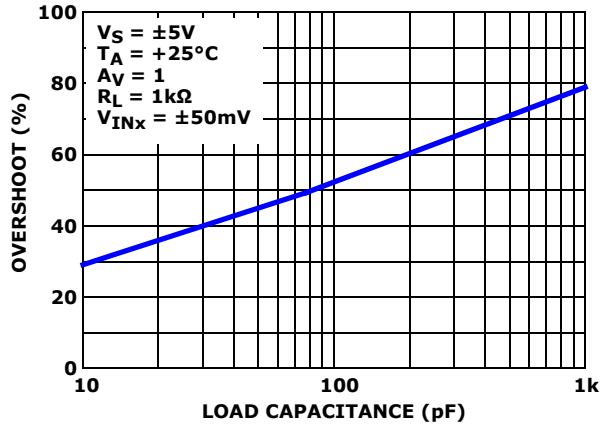

FIGURE 27. SMALL-SIGNAL OVERSHOOT vs LOAD CAPACITANCE

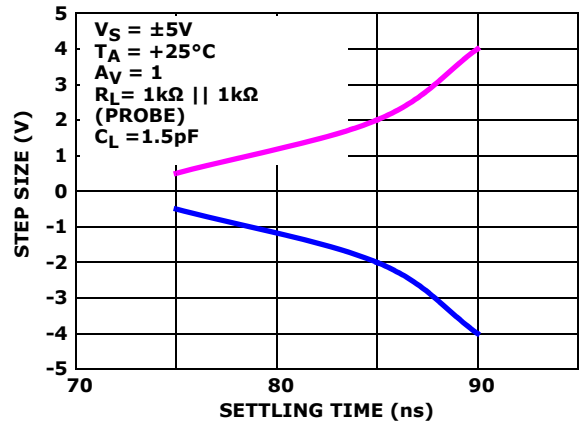

FIGURE 28. STEP SIZE vs SETTLE TIME

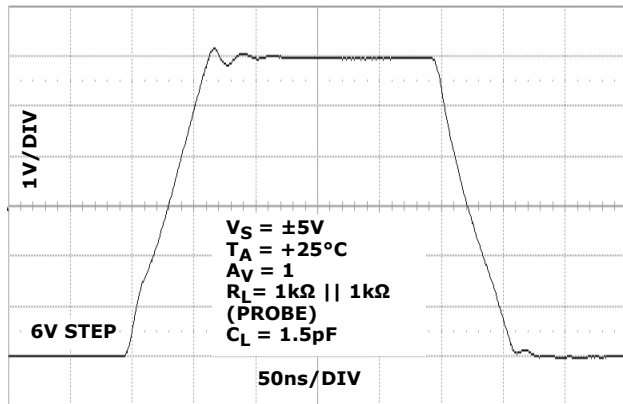

FIGURE 29. LARGE SIGNAL TRANSIENT RESPONSE

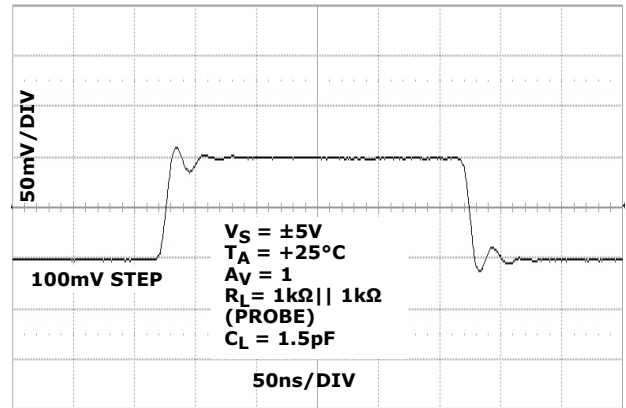

FIGURE 30. SMALL SIGNAL TRANSIENT RESPONSE

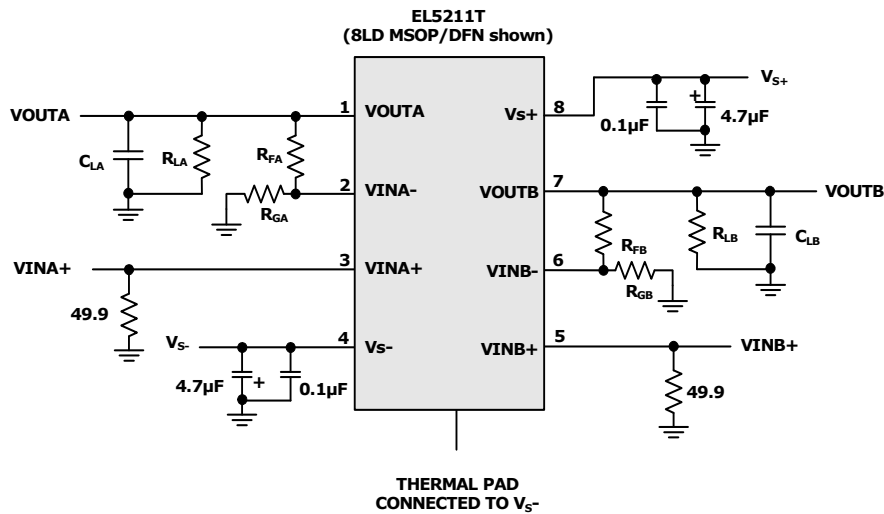

FIGURE 31. BASIC TEST CIRCUIT

## Applications Information

### Product Description

The EL5211T is a high voltage rail-to-rail input-output amplifier with low power consumption. The EL5211T contains four amplifiers. Each amplifier exhibits beyond the rail input capability, rail-to-rail output capability and is unity gain stable.

The EL5211T features a high slew rate of  $100\text{V}/\mu\text{s}$ , and fast settling time. Also, the device provides common mode input capability beyond the supply rails, rail-to-rail output capability, and a bandwidth of  $60\text{MHz}$  ( $-3\text{dB}$ ). This enables the amplifiers to offer maximum dynamic range at any supply voltage.

### Operating Voltage, Input and Output Capability

The EL5211T can operate on a single supply or dual supply configuration. The EL5211T operating voltage ranges from a minimum of  $4.5\text{V}$  to a maximum of  $19\text{V}$ . This range allows for a standard  $5\text{V}$  (or  $\pm 2.5\text{V}$ ) supply voltage to dip to  $-10\%$ , or a standard  $18\text{V}$  (or  $\pm 9\text{V}$ ) to rise by  $+5.5\%$  without affecting performance or reliability.

The input common-mode voltage range of the EL5211T extends  $500\text{mV}$  beyond the supply rails. Also, the EL5211T is immune to phase reversal. However, if the common mode input voltage exceeds the supply voltage by more than  $0.5\text{V}$ , electrostatic protection diodes in the input stage of the device begin to conduct. Even though phase reversal will not occur, to maintain optimal reliability it is suggested to avoid input overvoltage conditions. Figure 32 shows the input voltage driven  $500\text{mV}$  beyond the supply rails and the device output swinging between the supply rails.

The EL5211T output typically swings to within  $50\text{mV}$  of positive and negative supply rails with load currents of  $\pm 5\text{mA}$ . Decreasing load currents will extend the output voltage range even closer to the supply rails. Figure 33 shows the input and output waveforms for the device in a unity-gain configuration. Operation is from  $\pm 5\text{V}$  supply with a  $1\text{k}\Omega$  load connected to GND. The input is a  $10\text{V}_{\text{p-p}}$  sinusoid and the output voltage is approximately  $9.9\text{V}_{\text{p-p}}$ .

Refer to the "Electrical Specifications" Table beginning on page 3 for specific device parameters. Parameter variations with operating voltage, loading and/or temperature are shown in the "Typical Performance Curves" on page 6.

### Output Current

The EL5211T is capable of output short circuit currents of  $300\text{mA}$  (source and sink), and the device has built-in protection circuitry which limits the output current to  $\pm 300\text{mA}$  (typical).

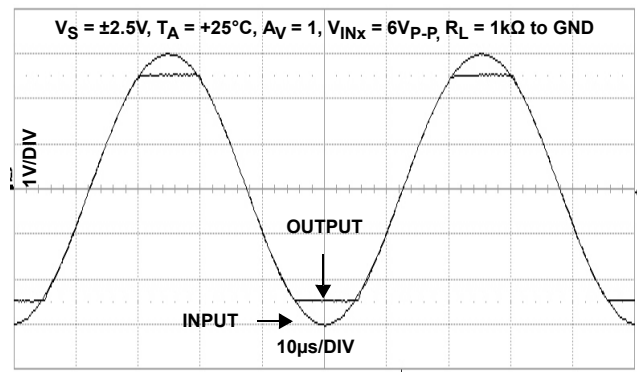

FIGURE 32. OPERATION WITH BEYOND-THE-RAILS INPUT

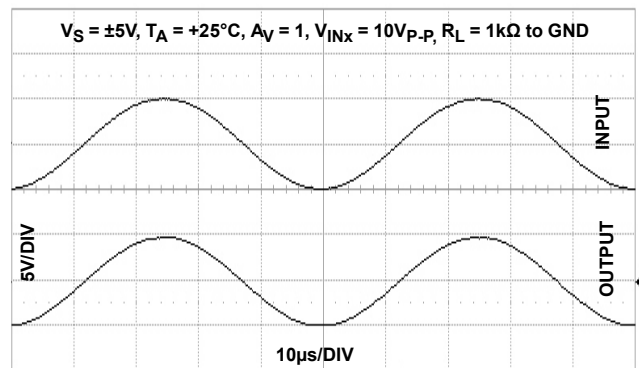

FIGURE 33. OPERATION WITH RAIL-TO-RAIL INPUT AND OUTPUT

To maintain maximum reliability, the continuous output current should never exceed  $\pm 65\text{mA}$ . This  $\pm 65\text{mA}$  limit is determined by the characteristics of the internal metal interconnects. Also, see "Power Dissipation" on page 12 for detailed information on ensuring proper device operation and reliability for temperature and load conditions.

### Unused Amplifiers

It is recommended that any unused amplifiers be configured as a unity gain follower. The inverting input should be directly connected to the output and the non-inverting input tied to the ground.

### Thermal Shutdown

The EL5211T has a built-in thermal protection which ensures safe operation and prevents internal damage to the device due to overheating. When the die temperature reaches  $+165^\circ\text{C}$  (typical), the device automatically shuts OFF the outputs by putting them in a high impedance state. When the die cools by  $+15^\circ\text{C}$  (typical), the device automatically turns ON the outputs by putting them in a low impedance (normal) operating state.

**Driving Capacitive Loads**

As load capacitance increases, the -3dB bandwidth will decrease and peaking can occur. Depending on the application, it may be necessary to reduce peaking and to improve device stability. To improve device stability a snubber circuit or a series resistor may be added to the output of the EL5211T.

A snubber is a shunt load consisting of a resistor in series with a capacitor. An optimized snubber can improve the phase margin and the stability of the EL5211T. The advantage of a snubber circuit is that it does not draw any DC load current or reduce the gain.

Another method to reduce peaking is to add a series output resistor (typically between 1Ω to 10Ω). Depending on the capacitive loading, a small value resistor may be the most appropriate choice to minimize any reduction in gain.

**Power Dissipation**

With the high-output drive capability of the EL5211T amplifiers, it is possible to exceed the +150°C absolute maximum junction temperature under certain load conditions. It is important to calculate the maximum power dissipation of the EL5211T in the application. Proper load conditions will ensure that the EL5211T junction temperature stays within a safe operating region.

The maximum power dissipation allowed in a package is determined according to Equation 1:

$$P_{DMAX} = \frac{T_{JMAX} - T_{AMAX}}{\theta_{JA}} \quad (EQ. 1)$$

where:

- $T_{JMAX}$  = Maximum junction temperature
- $T_{AMAX}$  = Maximum ambient temperature
- $\theta_{JA}$  = Thermal resistance of the package
- $P_{DMAX}$  = Maximum power dissipation allowed

The total power dissipation produced by an IC is the total quiescent supply current times the total power supply voltage, plus the power dissipation in the IC due to the loads, or:

$$P_{DMAX} = \sum i[V_S \times I_{SMAX} + (V_S + -V_{OUTi}) \times I_{LOADi}] \quad (EQ. 2)$$

when sourcing, and:

$$P_{DMAX} = \sum i[V_S \times I_{SMAX} + (V_{OUTi} - V_S) \times I_{LOADi}] \quad (EQ. 3)$$

when sinking,

where:

- $i = 1$  to 2  
(1, 2 corresponds to Channel A, B respectively)
- $V_S$  = Total supply voltage ( $V_{S+} - V_{S-}$ )
- $V_{S+}$  = Positive supply voltage

- $V_{S-}$  = Negative supply voltage
- $I_{SMAX}$  = Maximum supply current per amplifier  
( $I_{SMAX} = \text{EL5211T quiescent current} \div 2$ )
- $V_{OUT}$  = Output voltage
- $I_{LOAD}$  = Load current

Device overheating can be avoided by calculating the minimum resistive load condition,  $R_{LOAD}$ , resulting in the highest power dissipation. To find  $R_{LOAD}$  set the two  $P_{DMAX}$  equations equal to each other and solve for  $V_{OUT}/I_{LOAD}$ . Reference the package power dissipation curves, Figures 34 and 35, for further information.

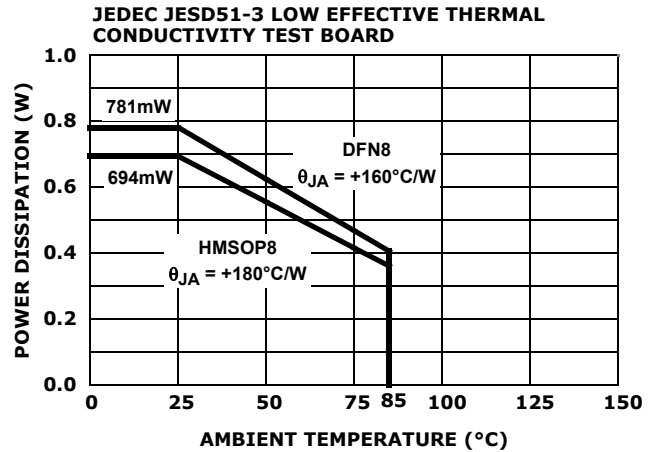

**FIGURE 34. PACKAGE POWER DISSIPATION vs AMBIENT TEMPERATURE**

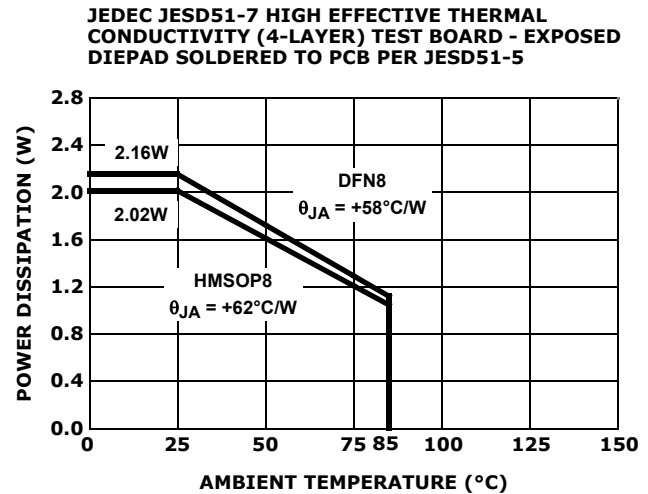

**FIGURE 35. PACKAGE POWER DISSIPATION vs AMBIENT TEMPERATURE**

**Power Supply Bypassing and Printed Circuit Board Layout**

The EL5211T can provide gain at high frequency, so good printed circuit board layout is necessary for optimum performance. Ground plane construction is highly recommended, trace lengths should be as short as

# EL5211T

possible and the power supply pins must be well bypassed to reduce any risk of oscillation.

For normal single supply operation (the  $V_{S-}$  pin is connected to ground) a 4.7 $\mu$ F capacitor should be placed from  $V_{S+}$  to ground, then a parallel 0.1 $\mu$ F capacitor should be connected as close to the amplifier as possible. One 4.7 $\mu$ F capacitor may be used for multiple devices. For dual supply operation, the same capacitor combination should be placed at each supply pin to ground.

It is highly recommended that EL5211T exposed thermal pad packages should always have the pad connected to the lowest potential,  $V_{S-}$ , to optimize thermal and operating performance. PCB vias should be placed below the device's exposed thermal pad to transfer heat to the  $V_{S-}$  plane and away from the device.

## Revision History

The revision history provided is for informational purposes only and is believed to be accurate, but not warranted. Please go to web to make sure you have the latest Rev.

DATE	REVISION	CHANGE
5/12/10	FN6893.0	Initial Release.
2/24/10	FN6893.0	Pre-release data sheet submitted for formatting.

## Products

Intersil Corporation is a leader in the design and manufacture of high-performance analog semiconductors. The Company's products address some of the industry's fastest growing markets, such as, flat panel displays, cell phones, handheld products, and notebooks. Intersil's product families address power management and analog signal processing functions. Go to [www.intersil.com/products](http://www.intersil.com/products) for a complete list of Intersil product families.

\*For a complete listing of Applications, Related Documentation and Related Parts, please see the respective device information page on intersil.com: [EL5211T](http://www.intersil.com/EL5211T)

To report errors or suggestions for this datasheet, please go to [www.intersil.com/askourstaff](http://www.intersil.com/askourstaff)

FITs are available from our website at <http://rel.intersil.com/reports/search.php>

# Package Outline Drawing

## L8.2x3

### 8 LEAD DUAL FLAT NO-LEAD PLASTIC PACKAGE

Rev 1, 3/10

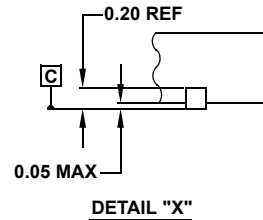
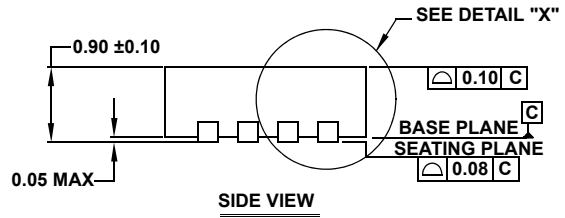
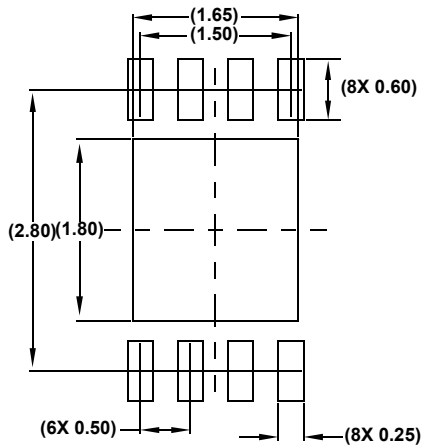
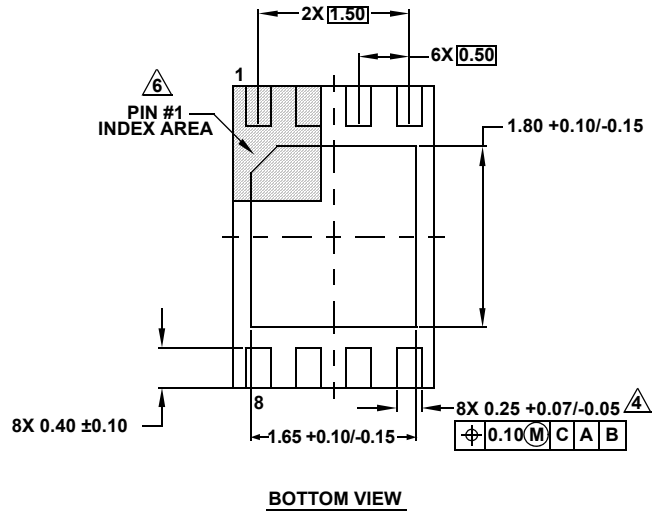
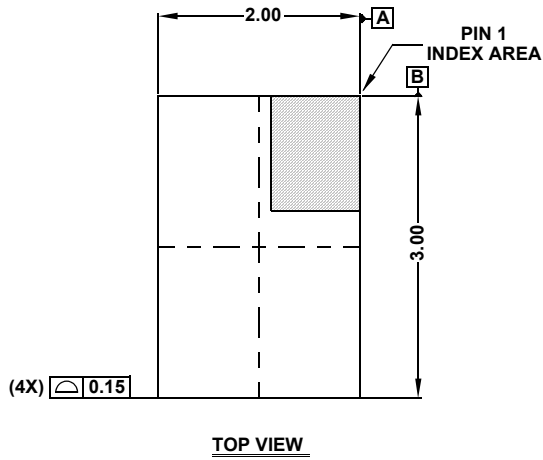

**NOTES:**

- Dimensions are in millimeters.  
Dimensions in ( ) for Reference Only.
- Dimensioning and tolerancing conform to ASME Y14.5m-1994.
- Unless otherwise specified, tolerance : Decimal ± 0.05
- Dimension applies to the metallized terminal and is measured between 0.25mm and 0.30mm from the terminal tip.
- Tiebar shown (if present) is a non-functional feature.
- The configuration of the pin #1 identifier is optional, but must be located within the zone indicated. The pin #1 identifier may be either a mold or mark feature.
- Complies to JEDEC MO-229 VCED-2.

**HMSOP (Heat-Sink MSOP) Package Family**

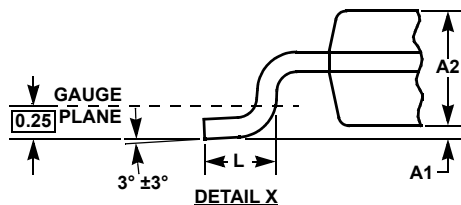
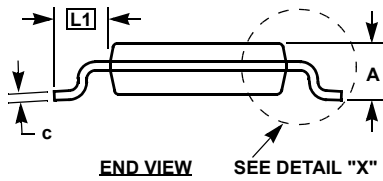
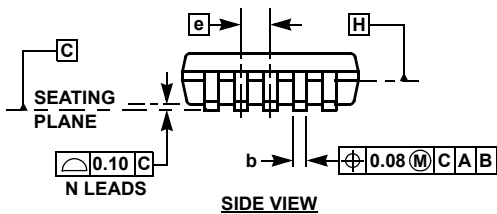
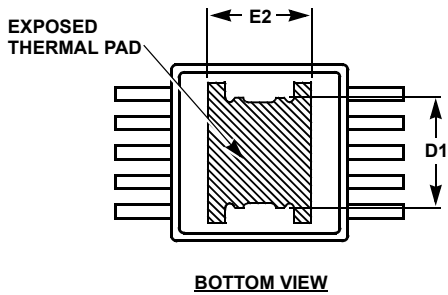
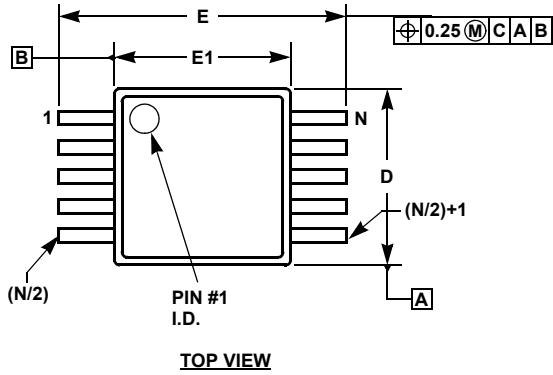

**MDP0050**

**HMSOP (HEAT-SINK MSOP) PACKAGE FAMILY**

SYMBOL	MILLIMETERS		TOLERANCE	NOTES
	HMSOP8	HMSOP10		
A	1.00	1.00	Max.	-
A1	0.075	0.075	+0.025/-0.050	-
A2	0.86	0.86	±0.09	-
b	0.30	0.20	+0.07/-0.08	-
c	0.15	0.15	±0.05	-
D	3.00	3.00	±0.10	1, 3
D1	1.85	1.85	Reference	-
E	4.90	4.90	±0.15	-
E1	3.00	3.00	±0.10	2, 3
E2	1.73	1.73	Reference	-
e	0.65	0.50	Basic	-
L	0.55	0.55	±0.15	-
L1	0.95	0.95	Basic	-
N	8	10	Reference	-

Rev. 1 2/07

**NOTES:**

1. Plastic or metal protrusions of 0.15mm maximum per side are not included.
2. Plastic interlead protrusions of 0.25mm maximum per side are not included.
3. Dimensions "D" and "E1" are measured at Datum Plane "H".
4. Dimensioning and tolerancing per ASME Y14.5M-1994.

For additional products, see [www.intersil.com/product\\_tree](http://www.intersil.com/product_tree)

Intersil products are manufactured, assembled and tested utilizing ISO9001 quality systems as noted in the quality certifications found at [www.intersil.com/design/quality](http://www.intersil.com/design/quality)

*Intersil products are sold by description only. Intersil Corporation reserves the right to make changes in circuit design, software and/or specifications at any time without notice. Accordingly, the reader is cautioned to verify that data sheets are current before placing orders. Information furnished by Intersil is believed to be accurate and reliable. However, no responsibility is assumed by Intersil or its subsidiaries for its use; nor for any infringements of patents or other rights of third parties which may result from its use. No license is granted by implication or otherwise under any patent or patent rights of Intersil or its subsidiaries.*

For information regarding Intersil Corporation and its products, see [www.intersil.com](http://www.intersil.com)