

BG1A Universal High Power IGBT Module Gate Driver Board

BG1A-F kit contents: M57160AL gate driver and VLA106-15242 DC/DC converter.
BG2A-KA kit contents: VLA504 gate driver and VLA106-15242 DC/DC converter.

*The VLA504 replaces the older M57962L gate driver and the VLA106-15242 replaces the M57145L-01 DC/DC converter.

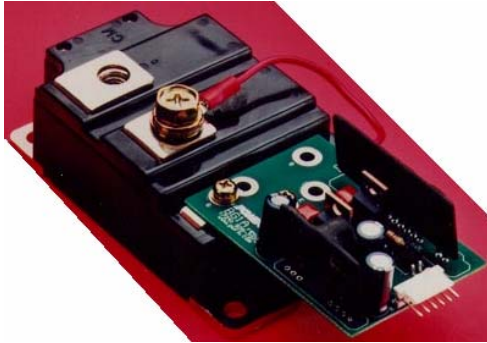

Description

BG1A is a fully isolated gate drive circuit board designed for use with high current single IGBT modules. When the board is populated, a VLA504 hybrid gate driver supplies the gate drive with complementary emitter follower power booster to provide efficient switching of modules rated up to 1200A. The hybrid gate drivers also provide protection against unexpected short circuit conditions. Isolated control power for the driver is supplied by an onboard VLA106-15242 regulated DC/DC converter. The fault feedback signal is also optically isolated.

See application note "Hybrid Circuits Simplify IGBT Module Gate Drive" at www.pwr.com.

Features

- 20A Peak Output Current
- 2500VRMS Isolation
- Direct Mounting to IGBT
- +15V to -8.5V Output Voltage Swing
- Wide Input Voltage Range +12V to +18V

Applications Designed for use with the following Powerex Single IGBT Modules

- CM600HU-12H/F
- CM400/600HU-24H/F
- CM800/1000HA-24H
- CM800/1000HA-28H
- CM1200HA-24J

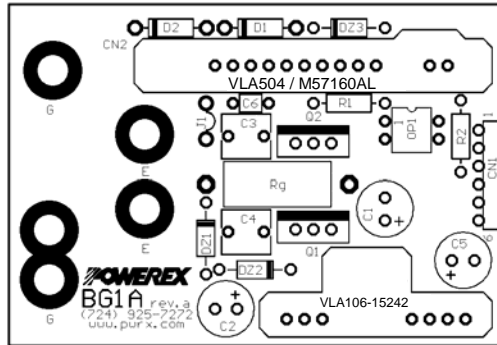

Schematic Diagram

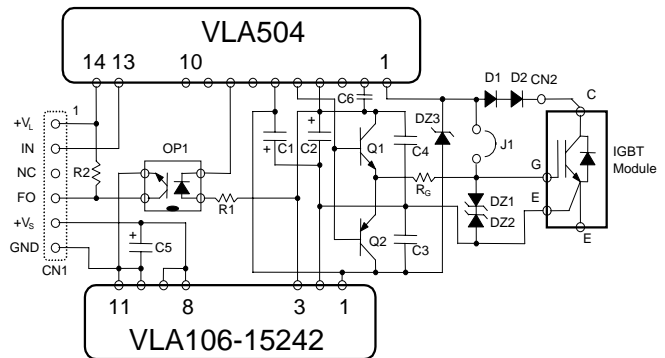

Rapid Design - Component List

Designation	Description	Value	Example Type
C1,C2	Power supply decoupling capacitors. Low impedance long life type.	150µF 35V	Panasonic FC EEUFC1V151
C3,C4	Low ESR polyester film or ceramic decoupling capacitors	1µF 50V	Panasonic ECQV1H105J L
C5	DC to DC converter input decoupling capacitor. Low impedance long life type	150µF 35V	Panasonic FC EEUFC1V151
C6	Optional - For adjustment of short circuit protection trip time.	0 to 200pF 50V	muRata RPE Series
R1	Current limit for fault opto	4.7K .25W	
R2	Pull up for fault output	4.7K .25W	
RG	Series gate resistor - See Powerex IGBT application notes	0.5Ω to 33Ω 0.5 to 2W	
D1, D2	Collector voltage detection diodes. Vrrm greater than IGBT Vces rating.	1A, 1000V tr<100ns	Motorola MUR1100E
DZ1, DZ2	Gate protection zeners	17V, 0.5W	1N5247
DZ3	Detect pin protection zener	30V, 0.5W	1N5256
Q1	NPN Booster transistor	15A, 80V	ONsemi D44VH10
Q2	PNP Booster transistor	15A, 80V	Motorola D45VH10
OP1	Opto for fault signal isolation		NEC PS2501
CN1	MTA100 6 position right angle header with locking ramp		AMP 640457-6
CN2	5/16" Ring Lug on 3.5" wire		AMP 34151
J1	Insert when using M57160AL with F-Series IGBT modules and omit D1, D2, DZ1-DZ3		

Typical Interface Circuit

