

# Power Management IC Series for Automotive Body Control Regulator with Voltage Detector IC



BD3951F

No.09039EAT05

## ●Description

BD3951F is a 5V LDO system regulator particularly developed for automotive applications. The output current of the regulator can be drawn up to 150mA, and it has built-in power-on reset and input voltage sense. This device can withstand 50V surge input voltage as well as wide ambient temperature operations from -40°C to +125°C. The adjustable reset delay time and detection input voltage allow to meet with wide range of design requirements.

## ●Features

- 1) Micro processor power supply 5.0V, Adjustable Reset, Adjustable Comparator.
- 2) 5V is Pch DMOS type low drop out voltage regulator. I<sub>omax</sub>=150mA.
- 3) Low ESR capacitor (Ceramic Capacitor) is available for the Output Capacitor.
- 4) Over Current Protection built in to prevent the destruction of IC.
- 5) Thermal Shut Down is built in to prevent the heat runaway.
- 6) VCC absolute Maximum Ratings 36V.
- 7) Vcc peak input voltage 50V (\*1)
- 8) Small surface mount package SOP8.

## ●Applications

Automotive application (Rain Sensor and Cluster Panel etc.) and all other electronics application.

## ●Absolute Maximum Ratings (Ta=25°C)

Parameter	Symbol	Limit	Unit
Vcc Input Voltage	Vcc	-0.3~+36	V
Out Terminal Voltage	Vout	-0.3~+7	V
RES Terminal Voltage	Vres	-0.3~+7	V
SOUT Terminal Voltage	Vsout	-0.3~+7	V
RES Output Current	Ires	0.2	mA
SOUT Output Current	Isout	2.5	mA
SIN Input Voltage	Vsin	-0.3~+36 <sup>*3</sup>	V
Power Dissipation	Pd	687 <sup>*2</sup>	mW
Operating Temperature Range	Topr	-40~+125	°C
Storage Temperature Range	Tstg	-55~+150	°C
Vcc Peak Input Voltage	Vccpeak	50 <sup>*1</sup>	V

\*1 tr (rising time) is over 1msec, applied voltage is less than 400msec

\*2 Pd is derated at 5.5mW/°C for temperature above Ta=25°C, mounted on 70mm×70mm×1.6mm PCB.

\*3 Input current from Vcc to SIN PIN has to be equal and less than 5mA when Vcc voltage is less than SIN PIN voltage.

## ●Operating Conditions (Ta=-40°C~+125°C)

Parameter	Symbol	Limit			Unit
		Min.	Typ.	Max.	
Recommended Supply Voltage <sup>*4</sup>	Vcc	6.0	13.5	20	V
Operational Supply Voltage <sup>*5</sup>	Vcc	5.5	13.5	36	V
Reset Adjustable Range	Vdet	4	-	4.7	V
Reset Delay Time Controllable Range	Cct	-	-	10	μF
Vcc Detection Adjustable Range	Vcc	5	-	-	V

\*4 The range within test condition of the electrical characteristics.

\*5 The range exceeding the test condition of the electrical characteristics.

## ●Electrical Characteristics (Unless otherwise specified Ta=-40°C~+125°C, Vcc=13.5V)

Parameter	Symbol	Limit			Unit	Condition
		Min.	Typ.	Max.		
[Whole Device]						
Input Current	Icc	-	135	210	μA	Iout=0.3mA
[Regulator Block]						
Output Voltage	Vout	4.90	5.00	5.10	V	Vcc=6~20V, Iout=1~100mA
Line Regulation	Lin.Reg	-	10	20	mV	Vcc=6~20V
Load Regulation	Load.Reg	-	15	30	mV	Iout=1~100mA
Dropout Voltage	ΔVd	-	0.31	0.50	V	Vcc=4.75V, Io=100mA
Output Peak Current	Iomax	150	-	-	mA	(Current Limit)
[Reset Block]						
Threshold Voltage	Vdet	Vout ×0.92	Vout ×0.94	Vout ×0.96	V	
Hysteresis Voltage	Vhys	50	100	150	mV	
Reset Delay Time L->H	TdLH	17	30	-	mS	CT=0.1μF <sup>*6</sup>
Reset Delay Time H->H	TdHL	-	4	-	μS	CT=0.1μF
RES Pull Up Resistor	Rrst	10	20	40	kΩ	
RES Low Output Voltage	VrL	-	0.08	0.40	V	4V<Vout<Vdet, Input Current is 0.2mA
Reset Adjustable Voltage	Vradj	1.18	1.26	1.34	V	
[Vcc Detection Block]						
Threshold Voltage	Vsdet	1.19	1.26	1.33	V	
Hysteresis Voltage	Vsdet off	1.240	1.335	1.430	V	
SOUT Pull Up Resistor	Rso	10	20	40	kΩ	
SOUT Low Output Voltage	VsL	-	0.06	0.40	V	Vout>4V, Vsin<Vsdet Input Current is 1.5mA
SIN Input Current	I <sub>sin</sub>	-1	0	1	μA	Vsin=2V

\*6 TdLH set by Cct terminal capacitor. TdLH ≈ 300kxCct

●Reference Data (Unless otherwise specified Ta=-40°C~+125°C, Vcc=13.5V)

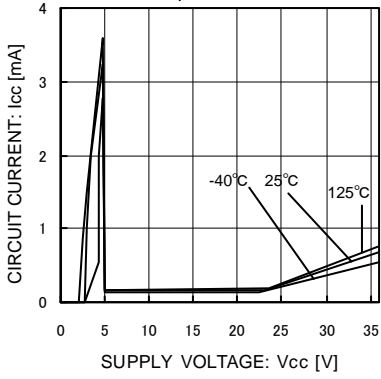

Fig.1 Circuit Current

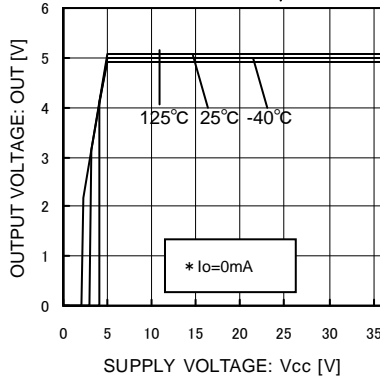

Fig.2 Line Regulation

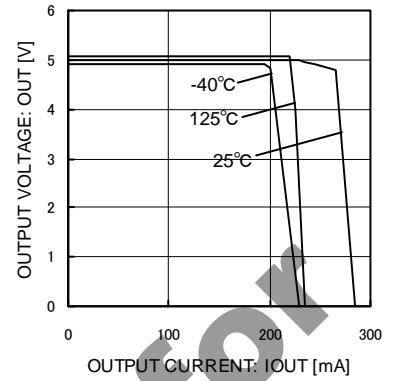

Fig.3 Load Regulation

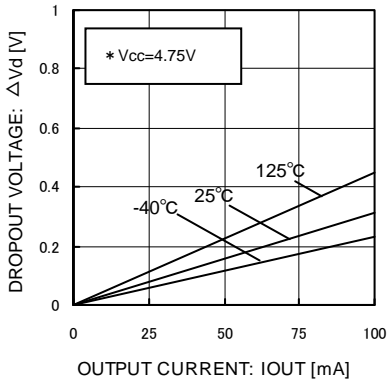

Fig.4 Drop Out Voltage

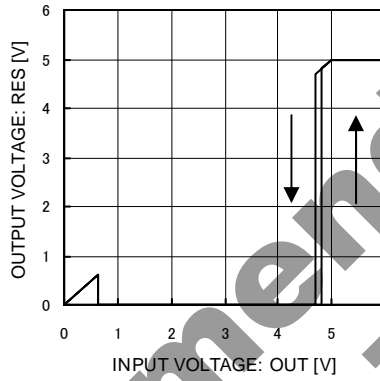

Fig.5 Reset Detection Voltage

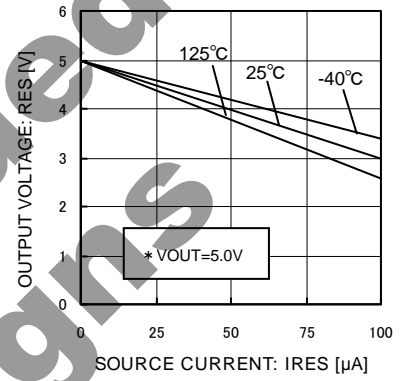

Fig.6 RES Pull Up Resistor

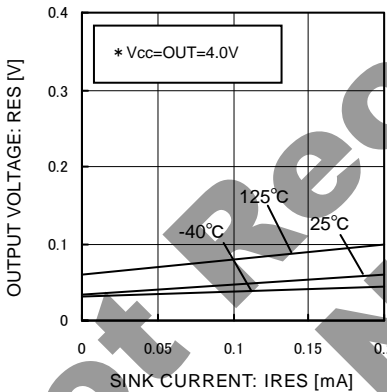

Fig.7 RES Sink Current

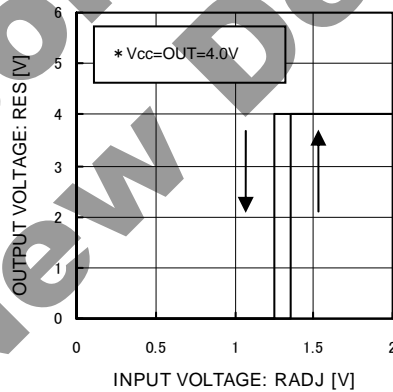

Fig.8 RADJ Detect Voltage

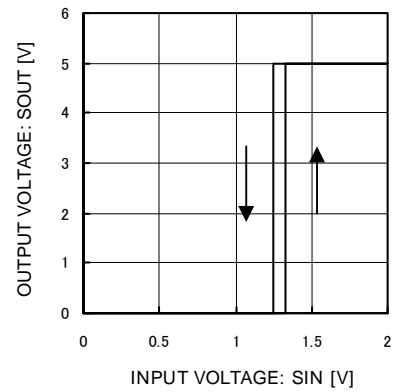

Fig.9 SIN Detect Voltage

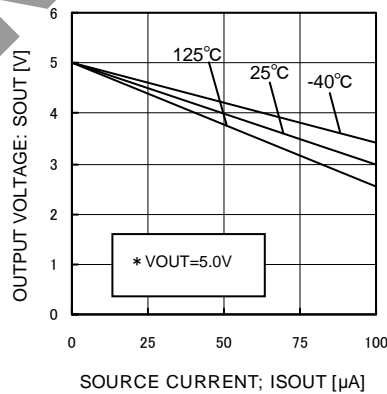

Fig.10 SOUT Pull Up Resistor

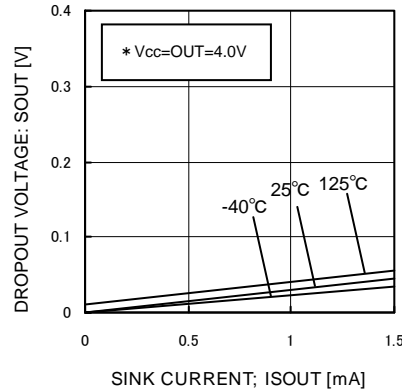

Fig.11 SOUT Sink Current

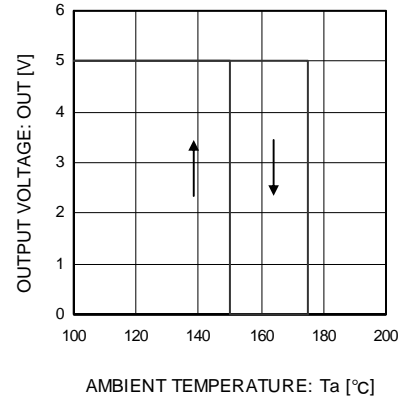

Fig.12 Thermal Shut Down

●Block Diagram, Application Circuit, Pin Description

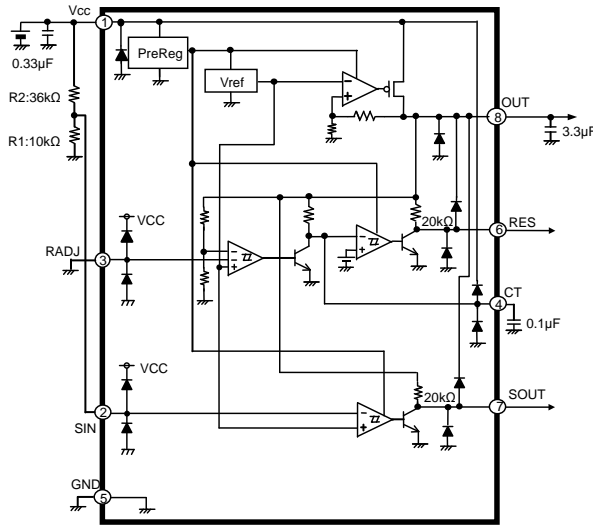

Fig.13

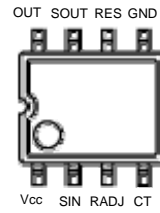
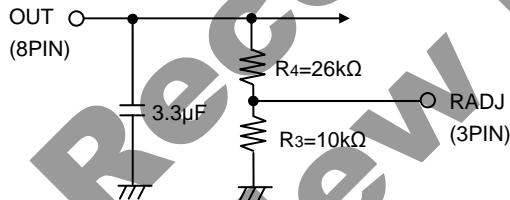

Fig.14

PIN	External Component	Value
Vcc	Capacitor :Cin	0.33μF~10mF
OUT	Capacitor :Co	3.3μF~2200μF
CT	Capacitor :Cct	0.01μF~10μF
SIN	Resistor :R1,R2	0Ω~100kΩ
RADJ	Resistor :R3,R4	0Ω~100kΩ

- ESR range of the output capacitor Co is 0 (ceramic capacitor) to 100Ω.
- VCC must be more than 5V under the condition SIN is used for VCC voltage drop detection.  
 Ex. Vcc=5.8V detection, Since  $1.26V * (R1+R2)/R1=5.8V$ ,  
 R1=10kΩ,R2=36kΩ
- Reset detection voltage must be more than 4V under the condition RADJ is used for OUT voltage drop detection.  
 Ex. OUT=4.5V detection, Since  $1.26V * (R3+R4)/R3=4.5V$ ,  
 R3=10kΩ,R4=26kΩ



RESET function can be discarded while RADJ terminal pulls up to OUT terminal, which in case RES terminal output "H". Battery detection function can be discarded while SIN terminal pulls up to OUT terminal, which in case SOUT terminal output "H". 0~47KΩ pull up resistors are recommended in both condition. Set application board test is necessary to select the right pull up resistor value.

●Terminal Description

Pin. No	Pin Name	Function
1	Vcc	Battery power supply
2	SIN	Battery voltage detection input terminal. Must be connected to OUT terminal while this function is not employed.
3	RADJ	RESET voltage adjustment terminal. Connect to GND in case internal detect voltage is employed
4	CT	RESET delay time control terminal
5	GND	IC GND terminal
6	RES	RESET output terminal. Built in 20KΩ pull up.
7	SOUT	Battery voltage detection output terminal. Built in 20KΩ pull up.
8	OUT	5.0V output terminal

●Input/Output terminal Circuit

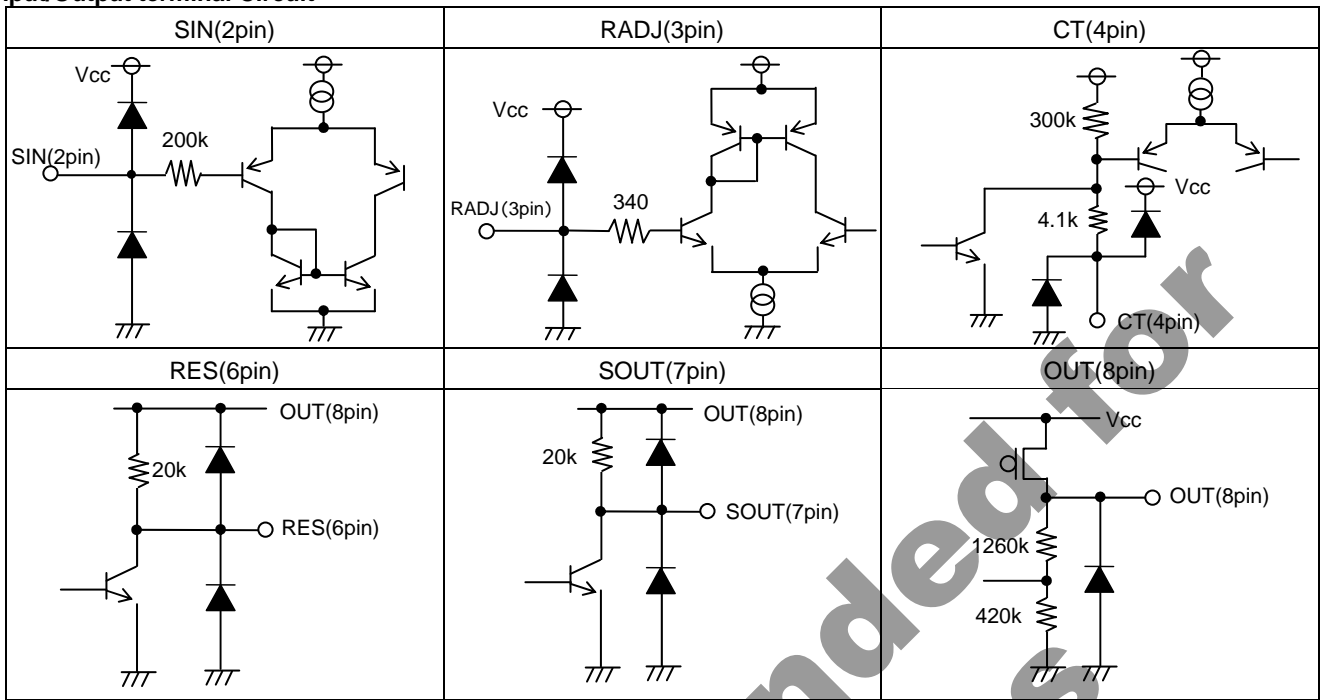

Fig.15

●How to set RESET delay time using CT terminal capacitor

There are three factors to define the RESET delay time TdLH. External capacitor value Cct of the CT terminal, internal charge resistor and internal reference voltage. RESET delay time is approximately described as below equation.

$$(TYP): TdLH \approx 300K \times Cct(sec)$$

Internal charge resistor 300k has some inaccuracy. The deviation of this inaccuracy is shown in Fig. 16. However, as TdLH delay time may be effected by application board, application board test is recommended to select the right Cct.

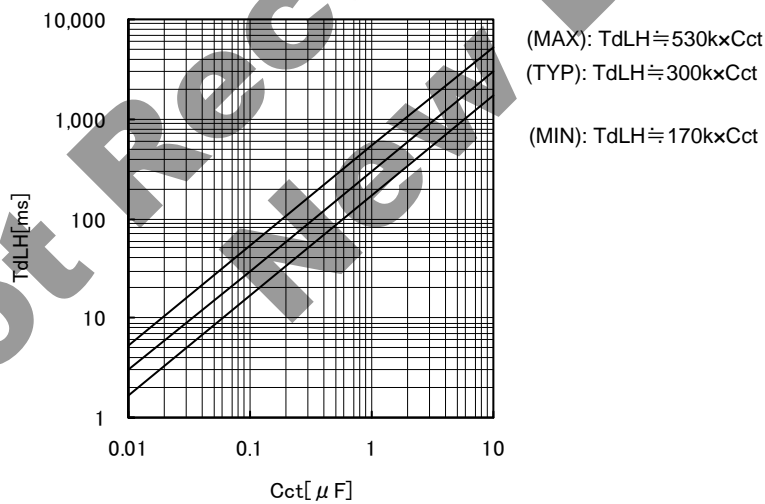

Fig.16

●Thermal Design

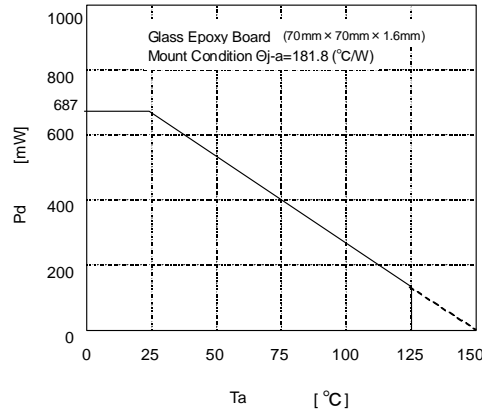

Fig.17

Please consider about power dissipation de-rating curve for high temperature operations. IC characteristics receive great effect from operating ambient temperature. If junction temperature exceeds rating temperature (Tjmax), device might degrade or be demolished permanently. Heat design should take consideration from both instant demolish and long life reliability. To prevent thermal destroy, IC must be operated under the condition that junction temperature is less than Tjmax. SOP8 package power dissipation temperature de-rating curve is shown in Fig. 17. Operating condition must be less than power dissipation curve. Calculation formula is as below.

$$P_c = (V_{cc} - V_{OUT}) \times I_{OUT} + V_{cc} \times I_{cc}$$

Power Dissipation  $P_d \leq P_c$

- $V_{cc}$  : Input Voltage
- $V_{OUT}$  : Output Voltage
- $I_{OUT}$  : Output Current
- $I_{cc}$  : Circuit Current

Derive  $I_{OUT}$  as operation is less than power dissipation curve,

$$I_{OUT} \leq \frac{P_d - V_{cc} \times I_{cc}}{V_{cc} - V_{OUT}} \quad (I_{cc} \text{ is shown in Fig. 1})$$

$I_{OUT}$  max is defined by  $V_{cc}$  and  $V_{OUT}$ .

Example

$T_a = 85^\circ\text{C}$ ,  $V_{cc} = 13.5\text{V}$  and  $V_{OUT} = 5\text{V}$

$$I_{OUT} \leq \frac{0.357 - 13.5 \times I_{cc}}{13.5 - 5}$$

$I_{OUT} \leq 41.8\text{mA} \quad (I_{cc} = 135\mu\text{A})$

$\theta_{j-a} = 181.8^\circ\text{C/W} \rightarrow 5.5\text{mW}/^\circ\text{C}$

$25^\circ\text{C} = 687\text{mW} \rightarrow 85^\circ\text{C} = 357\text{mW}$

Power consumption ( $P_c$ ) has to be less than power dissipation curve along with the temperature.

The equation under short circuit condition ( $V_{OUT} = \text{GND}$  short) is as below.

$$P_c = V_{cc} \times (I_{cc} + I_{short}) \quad I_{short} = \text{Short Current}$$

### ●Notes for use

1. This product are produced with strict quality control, but might be destroyed in using beyond absolute maximum ratings. The destroyed IC failure mode cannot be defined (like Short mode, or Open mode). Therefore physical safety guard, like fuse, is recommended to prevent unexpected extreme condition which might beyond absolute maximum ratings.
2. BD3951F can operate within the operating supply voltage range and operating temperature range. The Limits over the input voltage is not warranted, however electric characteristics curve in operating condition should be within the expected linearity.
3. GND terminal voltage must be always forced with the lowest voltage among the terminals.
4. Power GND pattern and Small signal GND pattern should be separated each other and is recommended to supply one point GND on the board to eliminate the surge current influences. External components GND pattern should not be long to avoid electrical interferences.
5. For thermal design, refer to the thermal de-rating characteristics and be sure to use this IC within the power dissipation range at any conditions.
6. Short circuits among the output terminals and short circuits between output terminals and VCC/GND terminal due to metallic foreign particles would result in permanent damage to the device. And this IC's Pin Assignment is 1pin=Vcc, 5pin=GND. So if this IC is mounted upside down, the device damaged permanently due to the huge current from GND pin to Vcc pin.
7. The extent electromagnetic condition might cause wrong operation of BD3951F.
8. Note that running set testing procedure using capacitors connected to low-impedance terminals may produce stress on the IC. Therefore, be certain to use proper discharge procedure before each process of the Testing. To prevent electrostatic stress in the assembly process, thoroughly ground yourself and any equipment that could sustain ESD potential, and continue observing ESD-prevention procedures in all handling, transfer and storage operations. Before attempting to any component to the test system, make certain that the power supply is OFF. Likewise, be sure to turn the power supply OFF before removing any component connected to the test system.
9. This IC is a Monolithic IC which has P+ isolation in the P substrate. A P-N junction is formed from this P layer and the N layer produces various types of parasitic devices. Fig. 18 shows parasitic devices around resistor and NPN transistor. f lower voltages than GND level are applied for A and B terminals, parasitic Di (P-N junction) would ON in both resistor and NPN transistor examples.

Moreover, in above condition, parasitic NPN transistor which is formed with parasitic Di and adjoined N layer would ON in NPN transistor example. Parasitic devices are inevitable in the structure of the IC. The operation of parasitic devices can result in mutual interference among circuits as well as operation faults and physical damage. Accordingly, you must not use methods by which parasitic diodes operate, such as applying a voltage that is lower than the GND (P substrate) voltage to an input pin.

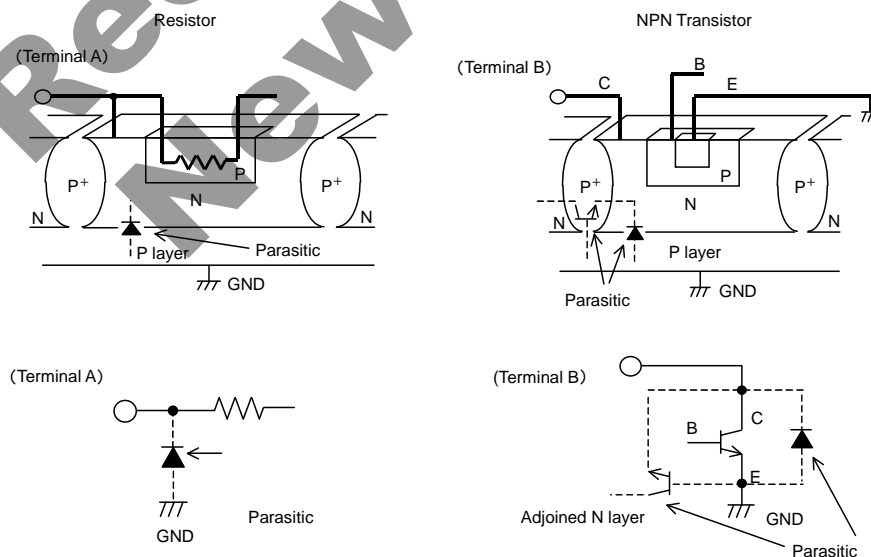

Fig.18 Bipolar Transistor

10. Output capacitor between output terminal and GND must be used to prevent undesirable oscillation. Ceramic Capacitor  $3.3\mu\text{F}\sim 2200\mu\text{F}$  can be used. When selecting the value of the output capacitor, please make sure that the operation on the actual application takes these conditions into account: rapid input or load transient response.
11. BD3951F might be damaged from the exceed inflow current from the terminals to VCC (for instance, VCC is short to GND while the output capacitor is charging.). In those cases, VCC series diode (to prevent inflow current) or bypass diode (connected from terminals to VCC) should be used externally in an application.
12. The over-current protection circuits are built in at the output to prevent the IC from being damaged when the load is short-circuited or over-current. This protection circuit is droop type and designed not to latch-up in an unexpected huge current driven.
13. BD3951F has thermal Shut Down protection (TSD) which performs Power Tr OFF in high  $T_j$  condition. If  $T_j$  increase more than TSD temperature, output power transistor would OFF. After  $T_j$  cooled down, the device would be recovered automatically. This function is designed for to protect the device at the accidental unexpected conditions. Since TSD setting is higher temperature than absolute maximum ratings, thermal design must has done not to use this function.
14. Bypass capacitor  $0.33\mu\text{F}\sim 10\text{mF}$  into the nearest position between VCC pin and GND is recommended.
15. Insert power zenner diode between VCC terminal and GND terminal is necessary, if more than 50V surge voltage would be supplied to VCC terminals.
16. The SOUT terminal is only activated ("H"/"L") while the RESET is "H". While the RESET terminal is "L", the SOUT terminal is always "L".

Not Recommended for New Designs



●Ordering part number

B	D
---	---

Part No.

3	9	5	1
---	---	---	---

Part No.  
3951

F
---

Package  
F: SOP8

E	2
---	---

Package and forming specification  
E2: Embossed tape and reel

SOP8

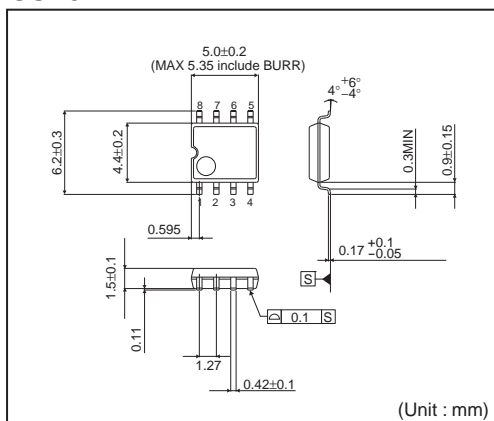

<Tape and Reel information>

Tape	Embossed carrier tape
Quantity	2500pcs
Direction of feed	E2 (The direction is the 1pin of product is at the upper left when you hold reel on the left hand and you pull out the tape on the right hand)

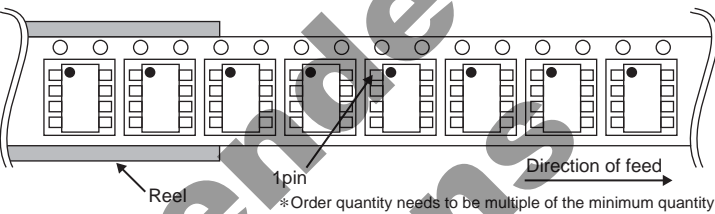

Not Recommended for New Design

# Notice

## Precaution on using ROHM Products

- Our Products are designed and manufactured for application in ordinary electronic equipments (such as AV equipment, OA equipment, telecommunication equipment, home electronic appliances, amusement equipment, etc.). If you intend to use our Products in devices requiring extremely high reliability (such as medical equipment <sup>(Note 1)</sup>, transport equipment, traffic equipment, aircraft/spacecraft, nuclear power controllers, fuel controllers, car equipment including car accessories, safety devices, etc.) and whose malfunction or failure may cause loss of human life, bodily injury or serious damage to property ("Specific Applications"), please consult with the ROHM sales representative in advance. Unless otherwise agreed in writing by ROHM in advance, ROHM shall not be in any way responsible or liable for any damages, expenses or losses incurred by you or third parties arising from the use of any ROHM's Products for Specific Applications.

(Note1) Medical Equipment Classification of the Specific Applications

JAPAN	USA	EU	CHINA
CLASS III	CLASS III	CLASS II b	CLASS III
CLASS IV		CLASS III	

- ROHM designs and manufactures its Products subject to strict quality control system. However, semiconductor products can fail or malfunction at a certain rate. Please be sure to implement, at your own responsibilities, adequate safety measures including but not limited to fail-safe design against the physical injury, damage to any property, which a failure or malfunction of our Products may cause. The following are examples of safety measures:
  - Installation of protection circuits or other protective devices to improve system safety
  - Installation of redundant circuits to reduce the impact of single or multiple circuit failure
- Our Products are designed and manufactured for use under standard conditions and not under any special or extraordinary environments or conditions, as exemplified below. Accordingly, ROHM shall not be in any way responsible or liable for any damages, expenses or losses arising from the use of any ROHM's Products under any special or extraordinary environments or conditions. If you intend to use our Products under any special or extraordinary environments or conditions (as exemplified below), your independent verification and confirmation of product performance, reliability, etc. prior to use, must be necessary:
  - Use of our Products in any types of liquid, including water, oils, chemicals, and organic solvents
  - Use of our Products outdoors or in places where the Products are exposed to direct sunlight or dust
  - Use of our Products in places where the Products are exposed to sea wind or corrosive gases, including Cl<sub>2</sub>, H<sub>2</sub>S, NH<sub>3</sub>, SO<sub>2</sub>, and NO<sub>2</sub>
  - Use of our Products in places where the Products are exposed to static electricity or electromagnetic waves
  - Use of our Products in proximity to heat-producing components, plastic cords, or other flammable items
  - Sealing or coating our Products with resin or other coating materials
  - Use of our Products without cleaning residue of flux (even if you use no-clean type fluxes, cleaning residue of flux is recommended); or Washing our Products by using water or water-soluble cleaning agents for cleaning residue after soldering
  - Use of the Products in places subject to dew condensation
- The Products are not subject to radiation-proof design.
- Please verify and confirm characteristics of the final or mounted products in using the Products.
- In particular, if a transient load (a large amount of load applied in a short period of time, such as pulse. is applied, confirmation of performance characteristics after on-board mounting is strongly recommended. Avoid applying power exceeding normal rated power; exceeding the power rating under steady-state loading condition may negatively affect product performance and reliability.
- De-rate Power Dissipation (Pd) depending on Ambient temperature (Ta). When used in sealed area, confirm the actual ambient temperature.
- Confirm that operation temperature is within the specified range described in the product specification.
- ROHM shall not be in any way responsible or liable for failure induced under deviant condition from what is defined in this document.

## Precaution for Mounting / Circuit board design

- When a highly active halogenous (chlorine, bromine, etc.) flux is used, the residue of flux may negatively affect product performance and reliability.
- In principle, the reflow soldering method must be used; if flow soldering method is preferred, please consult with the ROHM representative in advance.

For details, please refer to ROHM Mounting specification

**Precautions Regarding Application Examples and External Circuits**

1. If change is made to the constant of an external circuit, please allow a sufficient margin considering variations of the characteristics of the Products and external components, including transient characteristics, as well as static characteristics.
2. You agree that application notes, reference designs, and associated data and information contained in this document are presented only as guidance for Products use. Therefore, in case you use such information, you are solely responsible for it and you must exercise your own independent verification and judgment in the use of such information contained in this document. ROHM shall not be in any way responsible or liable for any damages, expenses or losses incurred by you or third parties arising from the use of such information.

**Precaution for Electrostatic**

This Product is electrostatic sensitive product, which may be damaged due to electrostatic discharge. Please take proper caution in your manufacturing process and storage so that voltage exceeding the Products maximum rating will not be applied to Products. Please take special care under dry condition (e.g. Grounding of human body / equipment / solder iron, isolation from charged objects, setting of ionizer, friction prevention and temperature / humidity control).

**Precaution for Storage / Transportation**

1. Product performance and soldered connections may deteriorate if the Products are stored in the places where:
  - [a] the Products are exposed to sea winds or corrosive gases, including Cl<sub>2</sub>, H<sub>2</sub>S, NH<sub>3</sub>, SO<sub>2</sub>, and NO<sub>2</sub>
  - [b] the temperature or humidity exceeds those recommended by ROHM
  - [c] the Products are exposed to direct sunshine or condensation
  - [d] the Products are exposed to high Electrostatic
2. Even under ROHM recommended storage condition, solderability of products out of recommended storage time period may be degraded. It is strongly recommended to confirm solderability before using Products of which storage time is exceeding the recommended storage time period.
3. Store / transport cartons in the correct direction, which is indicated on a carton with a symbol. Otherwise bent leads may occur due to excessive stress applied when dropping of a carton.
4. Use Products within the specified time after opening a humidity barrier bag. Baking is required before using Products of which storage time is exceeding the recommended storage time period.

**Precaution for Product Label**

QR code printed on ROHM Products label is for ROHM's internal use only.

**Precaution for Disposition**

When disposing Products please dispose them properly using an authorized industry waste company.

**Precaution for Foreign Exchange and Foreign Trade act**

Since our Products might fall under controlled goods prescribed by the applicable foreign exchange and foreign trade act, please consult with ROHM representative in case of export.

**Precaution Regarding Intellectual Property Rights**

1. All information and data including but not limited to application example contained in this document is for reference only. ROHM does not warrant that foregoing information or data will not infringe any intellectual property rights or any other rights of any third party regarding such information or data. ROHM shall not be in any way responsible or liable for infringement of any intellectual property rights or other damages arising from use of such information or data.:
2. No license, expressly or implied, is granted hereby under any intellectual property rights or other rights of ROHM or any third parties with respect to the information contained in this document.

**Other Precaution**

1. This document may not be reprinted or reproduced, in whole or in part, without prior written consent of ROHM.
2. The Products may not be disassembled, converted, modified, reproduced or otherwise changed without prior written consent of ROHM.
3. In no event shall you use in any way whatsoever the Products and the related technical information contained in the Products or this document for any military purposes, including but not limited to, the development of mass-destruction weapons.
4. The proper names of companies or products described in this document are trademarks or registered trademarks of ROHM, its affiliated companies or third parties.

**General Precaution**

1. Before you use our Products, you are requested to carefully read this document and fully understand its contents. ROHM shall not be in any way responsible or liable for failure, malfunction or accident arising from the use of any ROHM's Products against warning, caution or note contained in this document.
2. All information contained in this document is current as of the issuing date and subject to change without any prior notice. Before purchasing or using ROHM's Products, please confirm the latest information with a ROHM sales representative.
3. The information contained in this document is provided on an "as is" basis and ROHM does not warrant that all information contained in this document is accurate and/or error-free. ROHM shall not be in any way responsible or liable for any damages, expenses or losses incurred by you or third parties resulting from inaccuracy or errors of or concerning such information.

**Not Recommended for  
New Designs**