

AMMP-6546

18 to 40 GHz GaAs MMIC Sub-Harmonic Mixer
In SMT Package



Data Sheet

Description

Avago's AMMP-6546 is an easy-to-use broadband sub-harmonic mixer, with the LO injected at half of the frequency of that required by a conventional mixer. AMMP-6546 is similar to AMMP-6545 except that the layout is a mirror image designed to ease integration into transmitter or receiver designs. The MMIC includes an 180° balanced diode based mixer. The MMIC is fabricated using PHEMT technology. The surface mount package allows elimination of "chip & wire" assembly for lower cost. This MMIC is a cost effective alternative to multi-chip solution that have higher loss and complex assembly.

Applications

- Microwave radio systems
- Satellite VSAT, DBS up/down link
- LMDS & Pt-Pt mmW long haul
- Broadband wireless access (including 802.16 and 802.20 WiMax)
- WLL and MMDS loops

Package Diagram

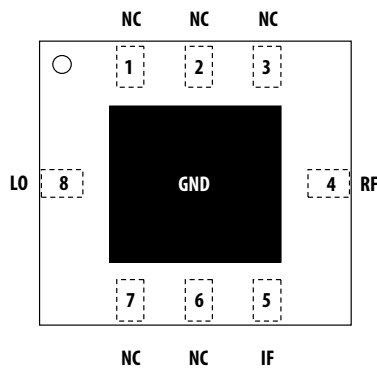

Features

- RF Frequency : 18-40 GHz
- LO Frequency : 9-20 GHz
- IF Frequency : DC-3.5 GHz
- 5x5 mm Surface Mount Package
- Suitable for Up and Down Conversion
- Diode Mixer
- **Typical Performance at RF= 21GHz**
Conversion Loss : 11 dB
IIP3 : +12 dBm
2LO-R Leakage : -44 dBm
2LO-I Leakage : -61 dBm
- **Typical Performance at RF= 23GHz**
Conversion Loss : 10 dB
IIP3 : +11.7 dBm
2LO-R Leakage : -40 dBm
2LO-I Leakage : -64 dBm
- **Typical Performance at RF= 26GHz**
Conversion Loss : 11 dB
IIP3 : +11.8 dBm
2LO-R Leakage : -42 dBm
2LO-I Leakage : -60 dBm

Functional Block Diagram

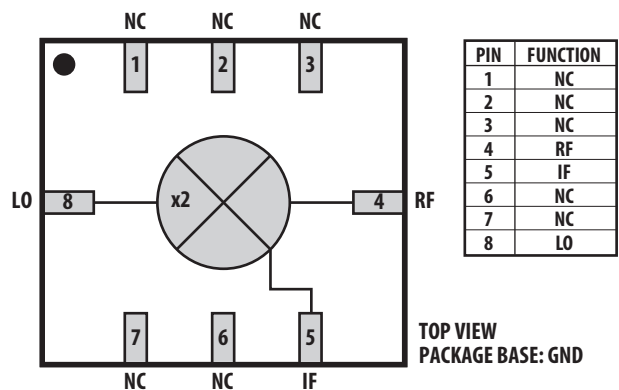

Attention: Observe precautions for handling electrostatic sensitive devices.
ESD Machine Model (Class A) : 30V
ESD Human Body Model (Class 0) : 100V
Refer to Avago Application Note A004R: Electrostatic Discharge, Damage and Control.

Electrical Specifications

1. Small/Large -signal data measured in a fully de-embedded test fixture form TA = 25°C.
2. Pre-assembly into package performance verified 100% on-wafer.
3. This final package part performance is verified by a functional test correlated to actual performance at one or more frequencies.
4. Specifications are derived from measurements in a 50 Ω test environment. Aspects of the amplifier performance may be improved over a more narrow bandwidth by application of additional conjugate, linearity, or low noise (Гopt) matching.
5. NF is measure on-wafer. Additional bond wires (-0.2nH) at Input could improve NF at some frequencies.

Table 1. RF Electrical Characteristics [1,2]

TA=25°C, Zo=50 Ω, LO=+15dBm, IF=2GHz

Parameter	RF=21GHz, LO=11.5GHz			RF=23GHz, LO=12.5GHz			RF=26GHz, LO=14GHz			Unit
	Min	Typ	Max	Min	Typ	Max	Min	Typ	Max	
Conversion Loss, CL		11	12		10	12		11	12	dB
Input Third Order Intercept, IIP3	11	12		10.5	11.7		8.5	11.8		dB
2LO-R Leakage, 2LO-R		-44	-35		-40	-35		-42	-30	dBm
2LO-I Leakage, 2LO-I		-61	-52.5		-64	-51.7		-60	-54	dBm
		RF=18-30GHz, LO=9-15GHz			RF=30-40GHz, LO=15-20GHz					
L-R Leakage, L-R		-30			-35					dB
L-I Leakage, L-I		-35			-30					dB

Note:

1. Production RF tested at 21, 23 and 26 GHz in up-converter configuration at Low Side LO.
2. All tested parameters are guaranteed with the following measurement accuracy:
 RF=21GHz: ±1 dBm for RF-leakage, ±2.0 dBm for IF-leakage, ±0.5dB for Conversion Loss, ±0.5 dBm for IIP3
 RF=23GHz: ±1 dBm for RF-leakage, ±2.5 dBm for IF-leakage, ±0.5dB for Conversion Loss, ±0.5 dBm for IIP3
 RF=26GHz: ±1 dBm for RF-leakage, ±2.5 dBm for IF-leakage, ±0.5dB for Conversion Loss, ±0.5 dBm for IIP3

Table 2. Recommended Operating Range

1. Ambient operational temperature TA = 25°C unless otherwise noted.

Parameter	Min.	Typical	Max.	Unit	Comments
RF Frequency, RFreq	18		40	GHz	
LO Frequency, LOFreq	9		20	GHz	
IF Frequency, IFreq	DC		3.5	GHz	
LO Power, LO	+12	+15	+22	dBm	

Absolute Minimum and Maximum Ratings

Table 3. Minimum and Maximum Ratings

Parameter	Min.	Max.	Unit	Comments
RF CW Input Power, Pin		+25	dB	
Storage Temperature, Tstg	-65	+150	°C	
Maximum Assembly Temperature, Tmax		300	°C	60 second maximum

Notes:

1. Operation in excess of any one of these conditions may result in permanent damage to this device.

AMMP-6546 Typical Performance Curves

($T_A = +25^\circ\text{C}$, $Z_{in}=Z_{out}=50\Omega$, IF Freq = 2GHz, LO Power = +15dBm unless noted)

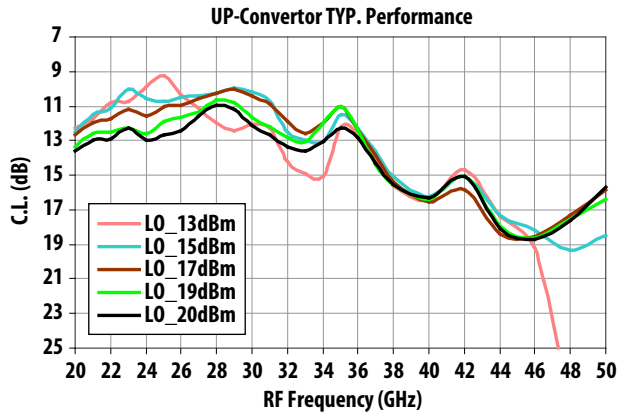

Figure 1. Up-conversion loss at LO = +13 to +20 dBm (high side LO)

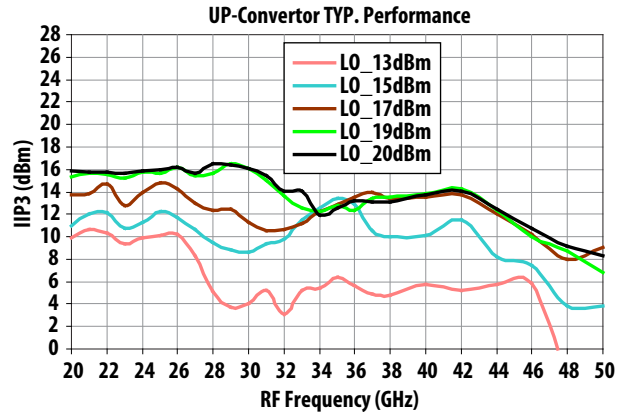

Figure 2. Up-conversion IIP3 at LO = +13 to +20 dBm (high side LO)

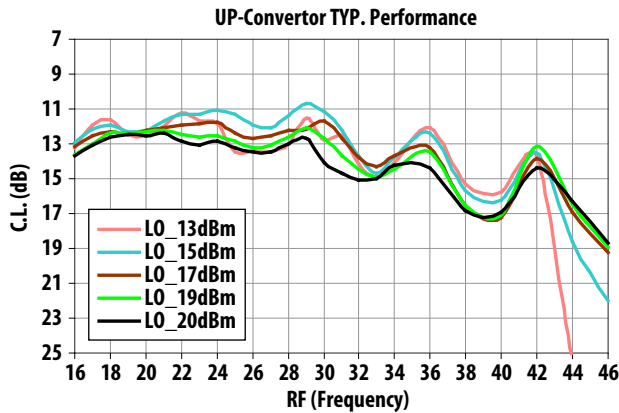

Figure 3. Up-conversion loss at LO = +13 to +20 dBm (low side LO)

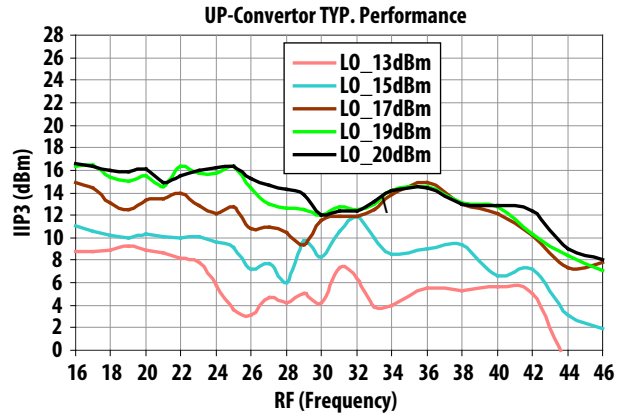

Figure 4. Up-conversion IIP3 at LO = +13 to +20 dBm (low side LO)

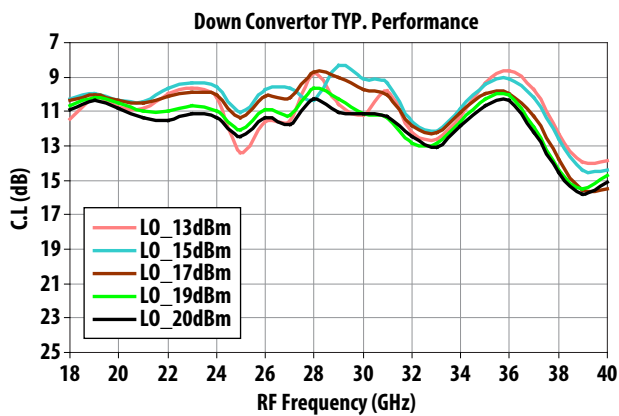

Figure 5. Down-conversion loss at LO = +13 to +20 dB (low side LO)

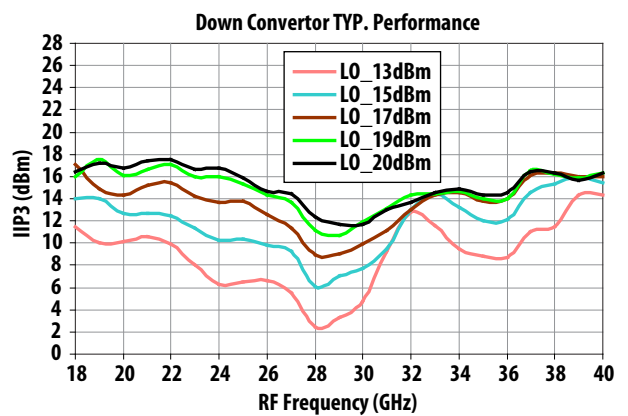

Figure 6. Down-conversion IIP3 at LO = +13 to +20 dBm (low side LO)

Notes:

1. Typical values were derived using limited samples during initial product characterization and may not be representative of the overall distribution.

AMMP-6546 Typical Performance Curves

($T_A = +25^\circ\text{C}$, $Z_{in}=Z_{out}=50\Omega$, IF Freq = 2GHz, LO Power = +15dBm unless noted)

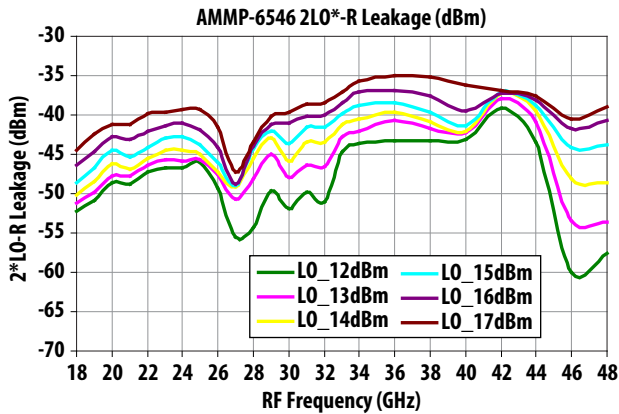

Figure 7. 2*LO-R leakage at LO = +12 to +17 dBm

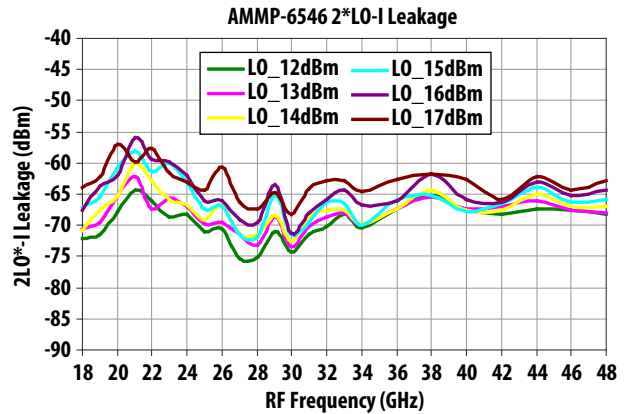

Figure 8. 2*LO-I leakage at LO = +12 to +17 dBm

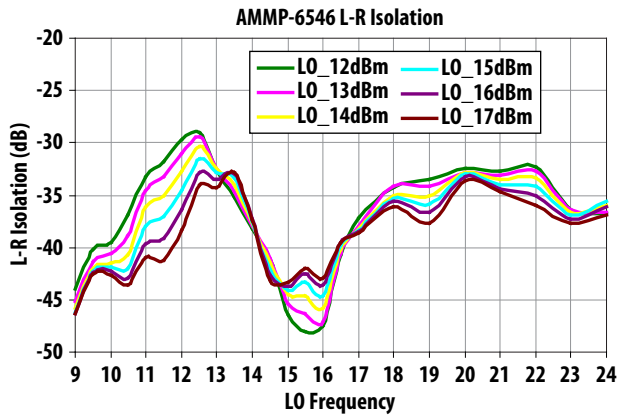

Figure 9. L-R isolation at LO = +12 to +17dBm

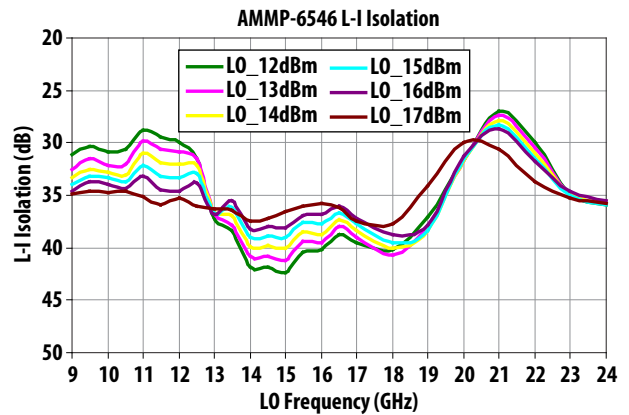

Figure 10. L-I isolation at LO = +12 to +17dBm

Notes:

1. Typical values were derived using limited samples during initial product characterization and may not be representative of the overall distribution.

AMMP-6546 Application and Usage

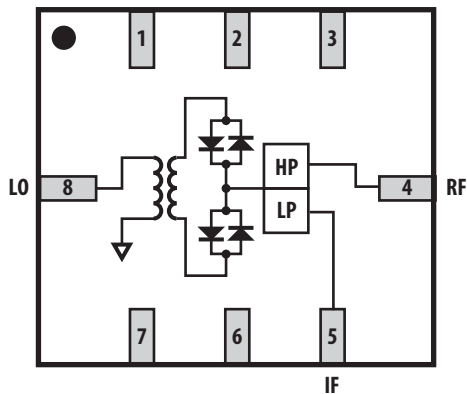

Figure 11. Simplified schematic of the mixer

Package Dimension, PCB Layout and Tape and Reel information

Please refer to Avago Technologies Application Note 5520, AMxP-xxxx production Assembly Process (Land Pattern A).

AMMP-6546 Part Number Ordering Information

Part Number	No. of Devices	Container
AMMP-6546-BLKG	10	antistatic bag
AMMP-6546-TR1G	100	7" Reel
AMMP-6546-TR2G	500	7" Reel

For product information and a complete list of distributors, please go to our web site: www.avagotech.com

Avago, Avago Technologies, and the A logo are trademarks of Avago Technologies in the United States and other countries.
Data subject to change. Copyright © 2005-2013 Avago Technologies. All rights reserved.
AV02-1662EN - July 9, 2013

