

**MATERIAL:**

BACKSHELL: ZINC ALLOY  
 COVER: ZINC ALLOY  
 MOUNTING SCREWS: STEEL, NICKEL PLATED  
 HOUSING SCREWS: STEEL, ZINC PLATED  
 GROUNDING SCREW: STEEL, ZINC PLATED  
 CABLE SLOT COVER: ZINC ALLOY  
 OPERATING TEMP: -40°C TO +90°C

CABLE DIAMETER  
 0.551 [14.00] MAX

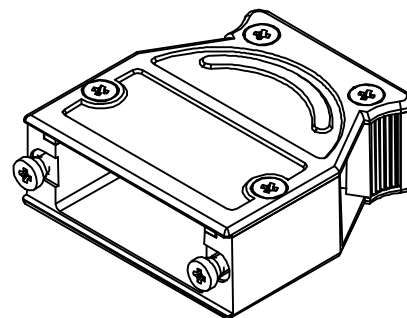
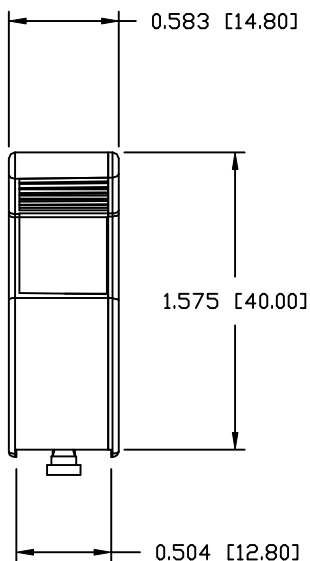
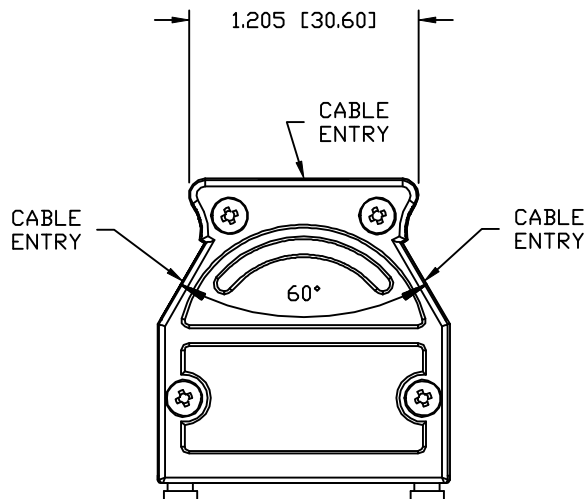
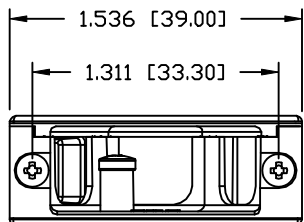

**BACKSHELL KIT INCLUDES:**

- (1) BACKSHELL
- (1) BACKSHELL COVER
- (2) MOUNTING SCREWS
- (4) HOUSING SCREWS
- (1) GROUNDING SCREW
- (2) CABLE SLOT COVER

GROUNDING SCREW (PHILLIPS)



HOUSING SCREW (PHILLIPS)



MOUNTING SCREW (PHILLIPS)



SLOT COVER

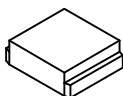

\*\*SEE PAGE 2 FOR CABLE CLAMPS

DO NOT SCALE FROM DRAWING



THESE DRAWINGS AND SPECIFICATIONS ARE THE PROPERTY OF NorComp AND SHALL NOT BE REPRODUCED, COPIED OR USED AS THE BASIS FOR THE MANUFACTURE OF SALE OF APPARATUS WITHOUT WRITTEN PERMISSION.

DRAWN: M. SIGMON		DATE: 08-16-16	
CHECKED:		DATE:	
SCALE: N.T.S.	SHEET 1 OF 2	REV 0	
DWG NO. 975M015-030R121			

RoHS COMPLIANT

NorComp

## CABLE CLAMPS ORDERED SEPARATELY

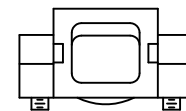
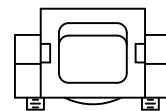
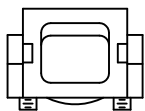
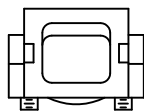
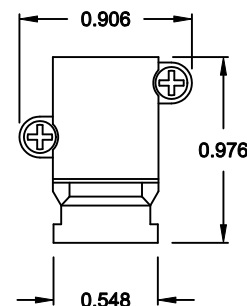
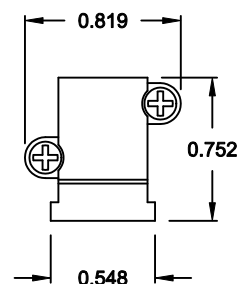
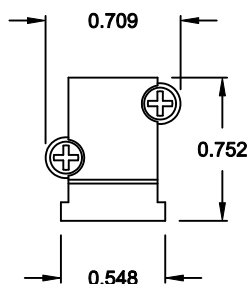
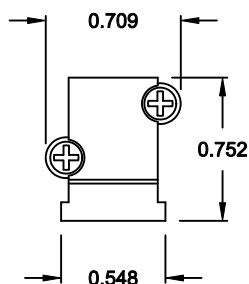
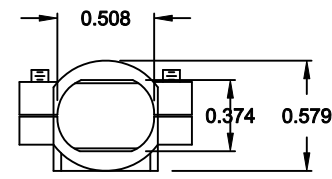
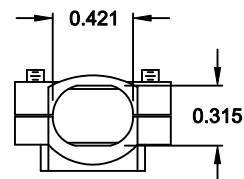
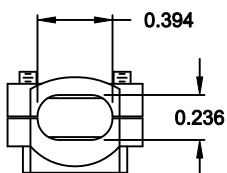
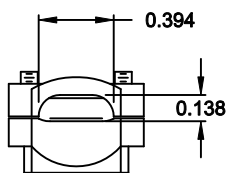

P/N 955-09-SR-4-7  
CABLE RANGE = 0.157 - 0.276

P/N 955-15-SR-7-10  
CABLE RANGE = 0.276 - 0.394

P/N 955-25-SR-9-12  
CABLE RANGE = 0.354 - 0.472

P/N 955-37-SR-11-14  
CABLE RANGE = 0.433 - 0.551

DO NOT SCALE FROM DRAWING



THESE DRAWINGS AND SPECIFICATIONS ARE THE PROPERTY OF NorComp AND SHALL NOT BE REPRODUCED, COPIED OR USED AS THE BASIS FOR THE MANUFACTURE OF SALE OF APPARATUS WITHOUT WRITTEN PERMISSION.

DRAWN:  
M. SIGMON

DATE:  
08-16-16

CHECKED:

DATE:

SCALE:  
N.T.S.

SHEET 2 OF 2

REV 0

# NorComp

DWG NO.

975M015-030R121

# RoHS COMPLIANT