

74AC821 • 74ACT821

10-Bit D-Type Flip-Flop with 3-STATE Outputs

General Description

The AC/ACT821 is a 10-bit D-type flip-flop with 3-STATE outputs arranged in a broadside pinout.

Features

- 3-STATE outputs for bus interfacing
- Noninverting outputs
- Outputs source/sink 24 mA
- TTL compatible inputs

Ordering Code:

| Order Number | Package Number | Package Description |
|--------------|----------------|---|
| 74AC821SC | M24B | 24-Lead Small Outline Integrated Circuit (SOIC), JEDEC MS-013, 0.300 Wide |
| 74AC821SPC | N24C | 24-Lead Plastic Dual-In-Line Package (PDIP), JEDEC MS-001, 0.300 Wide |
| 74ACT821SC | M24B | 24-Lead Small Outline Integrated Circuit (SOIC), JEDEC MS-013, 0.300 Wide |
| 74ACT821MTC | MTC24 | 24-Lead Thin Shrink Small Outline Package (TSSOP), JEDEC MO-153, 4.4mm Wide |
| 74ACT821SPC | N24C | 24-Lead Plastic Dual-In-Line Package (PDIP), JEDEC MS-001, 0.300 Wide |

Device also available in Tape and Reel. Specify by appending suffix letter "X" to the ordering code. (SPC not available in Tape and Reel.)

Logic Symbols

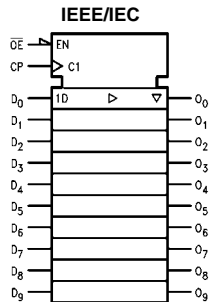
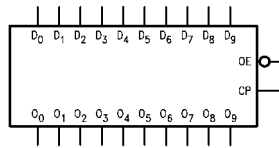

Connection Diagram

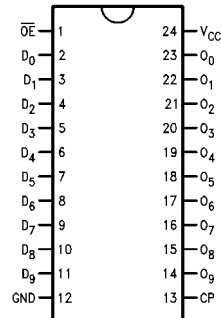

Pin Descriptions

| Pin Names | Description |
|--------------------------------|---------------------|
| D ₀ -D ₉ | Data Inputs |
| O ₀ -O ₉ | Data Outputs |
| \overline{OE} | Output Enable Input |
| CP | Clock Input |

FACT™ is a trademark of Fairchild Semiconductor Corporation.

Functional Description

The AC/ACT821 consists of ten D-type edge-triggered flip-flops. The buffered Clock (CP) and buffered Output Enable (\overline{OE}) are common to all flip-flops. The flip-flops will store the state of their individual D inputs that meet the setup and hold time requirements on the LOW-to-HIGH CP transition.

With \overline{OE} LOW the contents of the flip-flops are available at the outputs. When \overline{OE} is HIGH the outputs go to the high impedance state. Operation of the \overline{OE} input does not affect the state of the flip-flops.

Function Table

| Inputs | | | Internal | Outputs | Function |
|-----------------|----|---|----------|---------|----------|
| \overline{OE} | CP | D | Q | O | |
| H | ↗ | L | L | Z | High Z |
| H | ↗ | H | H | Z | High Z |
| L | ↗ | L | L | L | Load |
| L | ↗ | H | H | H | Load |

H = HIGH Voltage Level
 L = LOW Voltage Level
 Z = HIGH Impedance
 ↗ = LOW-to-HIGH Clock Transition

Logic Diagram

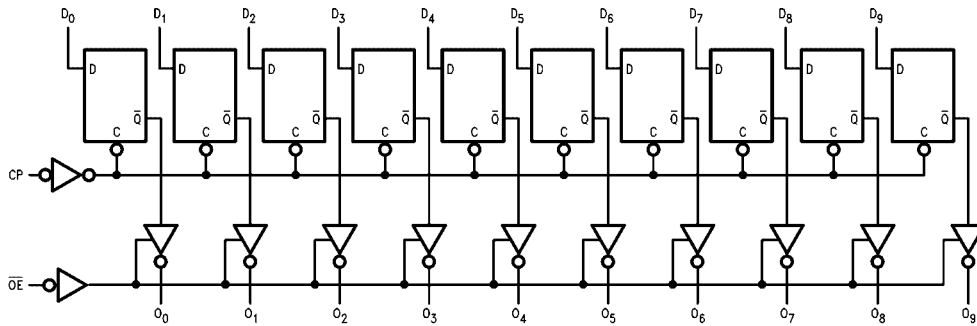

Please note that this diagram is provided only for the understanding of logic operations and should not be used to estimate propagation delays.

Absolute Maximum Ratings(Note 1)

| | |
|--|---------------------------|
| Supply Voltage (V_{CC}) | - 0.5V to + 7.0V |
| DC Input Diode Current (I_{IK}) | |
| $V_I = -0.5V$ | - 20 mA |
| $V_I = V_{CC} + 0.5V$ | + 20 mA |
| DC Input Voltage (V_I) | - 0.5V to $V_{CC} + 0.5V$ |
| DC Output Diode Current (I_{OK}) | |
| $V_O = -0.5V$ | - 20 mA |
| $V_O = V_{CC} + 0.5V$ | + 20 mA |
| DC Output Voltage (V_O) | - 0.5V to $V_{CC} + 0.5V$ |
| DC Output Source or Sink Current (I_O) | ± 50 mA |
| DC V_{CC} or Ground Current per Output Pin (I_{CC} or I_{GND}) | ± 50 mA |
| Storage Temperature (T_{STG}) | - 65°C to + 150°C |
| Junction Temperature (T_J) | |
| PDIP | 140°C |

Recommended Operating Conditions

| | |
|---|------------------|
| Supply Voltage (V_{CC}) | |
| AC | 2.0V to 6.0V |
| ACT | 4.5V to 5.5V |
| Input Voltage (V_I) | 0V to V_{CC} |
| Output Voltage (V_O) | 0V to V_{CC} |
| Operating Temperature (T_A) | - 40°C to + 85°C |
| Minimum Input Edge Rate ($\Delta V/\Delta t$) | |
| AC Devices | |
| V_{IN} from 30% to 70% of V_{CC} | |
| V_{CC} @ 3.3V, 4.5V, 5.5V | 125 mV/ns |
| Minimum Input Edge Rate ($\Delta V/\Delta t$) | |
| ACT Devices | |
| V_{IN} from 0.8V to 2.0V | |
| V_{CC} @ 4.5V, 5.5V | 125 mV/ns |

Note 1: Absolute maximum ratings are those values beyond which damage to the device may occur. The databook specifications should be met, without exception, to ensure that the system design is reliable over its power supply, temperature, and output/input loading variables. Fairchild does not recommend operation of FACT™ circuits outside databook specifications.

DC Electrical Characteristics for AC

| Symbol | Parameter | V_{CC} (V) | $T_A = +25^\circ\text{C}$ | | $T_A = -40^\circ\text{C to } +85^\circ\text{C}$ | | Units | Conditions |
|-------------------|-----------------------------------|-----------------|---------------------------|-------------------|---|---------|---|------------|
| | | | Typ | Guaranteed Limits | | | | |
| V_{IH} | Minimum HIGH Level Input Voltage | 3.0 | 1.5 | 2.1 | 2.1 | V | $V_{OUT} = 0.1V$ or $V_{CC} - 0.1V$ | |
| | | 4.5 | 2.25 | 3.15 | 3.15 | | | |
| | | 5.5 | 2.75 | 3.85 | 3.85 | | | |
| V_{IL} | Maximum LOW Level Input Voltage | 3.0 | 1.5 | 0.9 | 0.9 | V | $V_{OUT} = 0.1V$ or $V_{CC} - 0.1V$ | |
| | | 4.5 | 2.25 | 1.35 | 1.35 | | | |
| | | 5.5 | 2.75 | 1.65 | 1.65 | | | |
| V_{OH} | Minimum HIGH Level Output Voltage | 3.0 | 2.99 | 2.9 | 2.9 | V | $I_{OUT} = -50 \mu A$ | |
| | | 4.5 | 4.49 | 4.4 | 4.4 | | | |
| | | 5.5 | 5.49 | 5.4 | 5.4 | | | |
| | | 3.0 | | 2.56 | 2.46 | V | $V_{IN} = V_{IL}$ or V_{IH} $I_{OH} = -12$ mA $I_{OH} = -24$ mA $I_{OH} = -24$ mA (Note 2) | |
| | | 4.5 | | 3.86 | 3.76 | | | |
| | | 5.5 | | 4.86 | 4.76 | | | |
| V_{OL} | Maximum LOW Level Output Voltage | 3.0 | 0.002 | 0.1 | 0.1 | V | $I_{OUT} = 50 \mu A$ | |
| | | 4.5 | 0.001 | 0.1 | 0.1 | | | |
| | | 5.5 | 0.001 | 0.1 | 0.1 | | | |
| | | 3.0 | | 0.36 | 0.44 | V | $V_{IN} = V_{IL}$ or V_{IH} $I_{OL} = 12$ mA $I_{OL} = 24$ mA $I_{OL} = 24$ mA (Note 2) | |
| | | 4.5 | | 0.36 | 0.44 | | | |
| | | 5.5 | | 0.36 | 0.44 | | | |
| I_{IN} (Note 4) | Maximum Input Leakage Current | 5.5 | | ± 0.1 | ± 1.0 | μA | $V_I = V_{CC}, GND$ | |
| I_{OZ} | Maximum 3-STATE Current | 5.5 | | ± 0.5 | ± 5.0 | μA | V_I (OE) = V_{IL}, V_{IH} $V_I = V_{CC}, GND$ $V_O = V_{CC}, GND$ | |
| I_{OLD} | Minimum Dynamic | 5.5 | | | 75 | mA | $V_{OLD} = 1.65V$ Max | |
| I_{OHD} | Output Current (Note 3) | 5.5 | | | -75 | mA | $V_{OHD} = 3.85V$ Min | |
| I_{CC} (Note 4) | Maximum Quiescent Supply Current | 5.5 | | 8.0 | 80.0 | μA | $V_{IN} = V_{CC}$ or GND | |

Note 2: All outputs loaded; thresholds on input associated with output under test.

Note 3: Maximum test duration 2.0 ms, one output loaded at a time.

Note 4: I_{IN} and I_{CC} @ 3.0V are guaranteed to be less than or equal to the respective limit @ 5.5V V_{CC} .

DC Electrical Characteristics for ACT

| Symbol | Parameter | V _{CC} (V) | T _A = +25°C | | T _A = -40°C to +85°C | | Units | Conditions |
|-----------------------------|--------------------------------------|------------------------|------------------------|-------------------|---------------------------------|--|-------|---|
| | | | Typ | Guaranteed Limits | | | | |
| V _{IH} | Minimum HIGH Level Input Voltage | 4.5 | 1.5 | 2.0 | 2.0 | | V | V _{OUT} = 0.1V or V _{CC} - 0.1V |
| | | 5.5 | 1.5 | 2.0 | 2.0 | | | |
| V _{IL} | Maximum LOW Level Input Voltage | 4.5 | 1.5 | 0.8 | 0.8 | | V | V _{OUT} = 0.1V or V _{CC} - 0.1V |
| | | 5.5 | 1.5 | 0.8 | 0.8 | | | |
| V _{OH} | Minimum HIGH Level Output Voltage | 4.5 | 4.49 | 4.4 | 4.4 | | V | I _{OUT} = - 50 μA |
| | | 5.5 | 5.49 | 5.4 | 5.4 | | | |
| | | 4.5 | | 3.86 | 3.76 | | V | V _{IN} = V _{IL} or V _{IH} I _{OH} = - 24 mA I _{OH} = - 24 mA (Note 5) |
| | | 5.5 | | 4.86 | 4.76 | | | |
| V _{OL} | Maximum LOW Level Output Voltage | 4.5 | 0.001 | 0.1 | 0.1 | | V | I _{OUT} = 50 μA |
| | | 5.5 | 0.001 | 0.1 | 0.1 | | | |
| | | 4.5 | | 0.36 | 0.44 | | V | V _{IN} = V _{IL} or V _{IH} I _{OL} = 24 mA I _{OL} = 24 mA (Note 5) |
| | | 5.5 | | 0.36 | 0.44 | | | |
| I _{IN} (Note 4) | Maximum Input Leakage Current | 5.5 | | ±0.1 | ±1.0 | | μA | V _I = V _{CC} , GND |
| I _{OZ} | Maximum 3-STATE Current | 5.5 | | ±0.5 | ±5.0 | | μA | V _I = V _{IL} , V _{IH} V _O = V _{CC} , GND |
| I _{CCT} | Maximum I _{CC} /Input | 5.5 | 0.6 | | 1.5 | | mA | V _I = V _{CC} - 2.1V |
| I _{OLD} | Minimum Dynamic | 5.5 | | | 75 | | mA | V _{OLD} = 1.65V Max |
| I _{OHD} | Output Current (Note 6) | 5.5 | | | -75 | | mA | V _{OHD} = 3.85V Min |
| I _{CC} | Maximum Quiescent Supply Current | 5.5 | | 8.0 | 80.0 | | μA | V _{IN} = V _{CC} or GND |

Note 5: All outputs loaded; thresholds on input associated with output under test.

Note 6: Maximum test duration 2.0 ms, one output loaded at a time.

AC Electrical Characteristics for AC

| Symbol | Parameter | V _{CC} (V) (Note 7) | T _A = +25°C C _L = 50 pF | | | T _A = -40°C to +85°C C _L = 50 pF | | Units |
|------------------|---|------------------------------------|--|------------|------|---|------|-------|
| | | | Min | Typ | Max | Min | Max | |
| f _{MAX} | Maximum Clock Frequency | 3.3 5.0 | 110 120 | 145 160 | | 100 110 | | MHz |
| t _{PLH} | Propagation Delay CP to O _n | 3.3 | 3.0 | 8.0 | 13.0 | 3.0 | 15.0 | ns |
| | | 5.0 | 2.0 | 6.0 | 9.5 | 2.0 | 10.5 | |
| t _{PHL} | Propagation Delay CP to O _n | 3.3 | 3.0 | 8.0 | 13.0 | 3.0 | 15.0 | ns |
| | | 5.0 | 2.0 | 5.5 | 9.5 | 2.0 | 10.5 | |
| t _{PZH} | Output Enable Time OE to O _n | 3.3 | 2.5 | 6.0 | 11.0 | 2.5 | 12.0 | ns |
| | | 5.0 | 1.5 | 4.5 | 8.0 | 1.5 | 9.0 | |
| t _{PZL} | Output Enable Time OE to O _n | 3.3 | 2.5 | 6.5 | 11.0 | 2.5 | 12.0 | ns |
| | | 5.0 | 1.5 | 5.0 | 8.0 | 1.5 | 9.0 | |
| t _{PHZ} | Output Disable Time OE to O _n | 3.3 | 2.5 | 6.5 | 10.5 | 2.5 | 11.0 | ns |
| | | 5.0 | 1.5 | 5.0 | 8.0 | 1.5 | 8.5 | |
| t _{PLZ} | Output Disable Time OE to O _n | 3.3 | 2.5 | 6.0 | 10.5 | 2.5 | 11.0 | ns |
| | | 5.0 | 1.5 | 4.5 | 8.0 | 1.5 | 8.5 | |

Note 7: Voltage Range 3.3 is 3.3V ± 0.3V
Voltage Range 5.0 is 5.0V ± 0.5V

| AC Operating Requirements for AC | | | | | | | |
|----------------------------------|-------------------------|------------------------------------|--|--------------------|---|--|-------|
| Symbol | Parameter | V _{CC} (V) (Note 8) | T _A = +25°C C _L = 50 pF | | T _A = -40°C to +85°C C _L = 50 pF | | Units |
| | | | Typ | Guaranteed Minimum | | | |
| t _S | Setup Time, HIGH or LOW | 3.3 | -1.0 | 1.5 | 1.5 | | ns |
| | D _n to CP | 5.0 | -1.0 | 1.5 | 1.5 | | |
| t _H | Hold Time, HIGH or LOW | 3.3 | -1.0 | 3.5 | 4.0 | | ns |
| | D _n to CP | 5.0 | -1.0 | 3.5 | 4.0 | | |
| t _W | CP Pulse Width | 3.3 | 3.5 | 5.0 | 5.5 | | ns |
| | HIGH or LOW | 5.0 | 2.5 | 4.0 | 4.0 | | |

Note 8: Voltage Range 3.3 is 3.3V ± 0.3V
Voltage Range 5.0 is 5.0V ± 0.5V

| AC Electrical Characteristics for ACT | | | | | | | | |
|---------------------------------------|---|------------------------------------|--|-----|------|---|------|-------|
| Symbol | Parameter | V _{CC} (V) (Note 9) | T _A = +25°C C _L = 50 pF | | | T _A = -40°C to +85°C C _L = 50 pF | | Units |
| | | | Min | Typ | Max | Min | Max | |
| f _{MAX} | Maximum Clock Frequency | 5.0 | 120 | 150 | | 110 | | MHz |
| t _{PLH} | Propagation Delay CP to O _n | 5.0 | 2.0 | 6.0 | 9.5 | 1.5 | 10.5 | ns |
| t _{PHL} | Propagation Delay CP to O _n | 5.0 | 2.5 | 6.0 | 9.5 | 2.0 | 10.5 | ns |
| t _{PZH} | Output Enable Time OE to O _n | 5.0 | 2.5 | 7.0 | 10.5 | 2.0 | 11.5 | ns |
| t _{PZL} | Output Enable Time OE to O _n | 5.0 | 2.5 | 7.0 | 10.5 | 2.0 | 12.0 | ns |
| t _{PHZ} | Output Disable Time OE to O _n | 5.0 | 1.5 | 7.5 | 12.0 | 1.0 | 13.0 | ns |
| t _{PLZ} | Output Disable Time OE to O _n | 5.0 | 1.5 | 7.0 | 10.5 | 1.0 | 11.5 | ns |

Note 9: Voltage Range 5.0 is 5.0V ± 0.5V

| AC Operating Requirements for ACT | | | | | | | |
|-----------------------------------|---|-------------------------------------|--|--------------------|---|--|-------|
| Symbol | Parameter | V _{CC} (V) (Note 10) | T _A = +25°C C _L = 50 pF | | T _A = -40°C to +85°C C _L = 50 pF | | Units |
| | | | Typ | Guaranteed Minimum | | | |
| t _S | Setup Time, HIGH or LOW D _n to CP | 5.0 | 2.5 | 2.0 | 2.5 | | ns |
| t _H | Hold Time, HIGH or LOW D _n to CP | 5.0 | -0.5 | 2.0 | 2.5 | | ns |
| t _W | CP Pulse Width HIGH or LOW | 5.0 | 3.0 | 4.5 | 5.5 | | ns |

Note 10: Voltage Range 5.0 is 5.0V ± 0.5V

| Capacitance | | | | |
|-----------------|-------------------------------|------|-------|------------------------|
| Symbol | Parameter | Typ | Units | Conditions |
| C _{IN} | Input Capacitance | 4.5 | pF | V _{CC} = OPEN |
| C _{PD} | Power Dissipation Capacitance | 35.0 | pF | V _{CC} = 5.0V |

Physical Dimensions inches (millimeters) unless otherwise noted

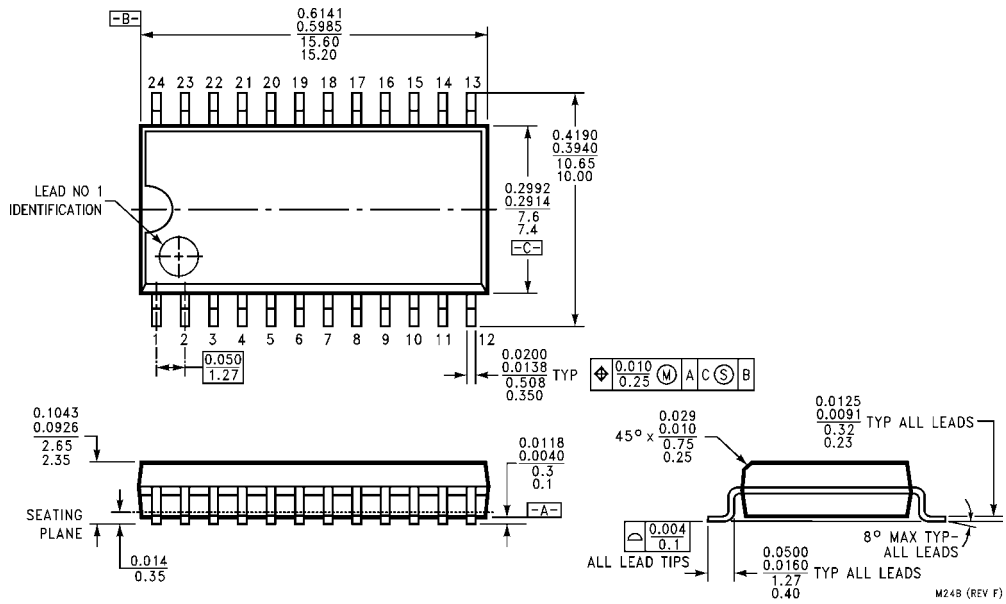

**24-Lead Small Outline Integrated Circuit (SOIC), JEDEC MS-013, 0.300 Wide
Package Number M24B**

Physical Dimensions inches (millimeters) unless otherwise noted (Continued)

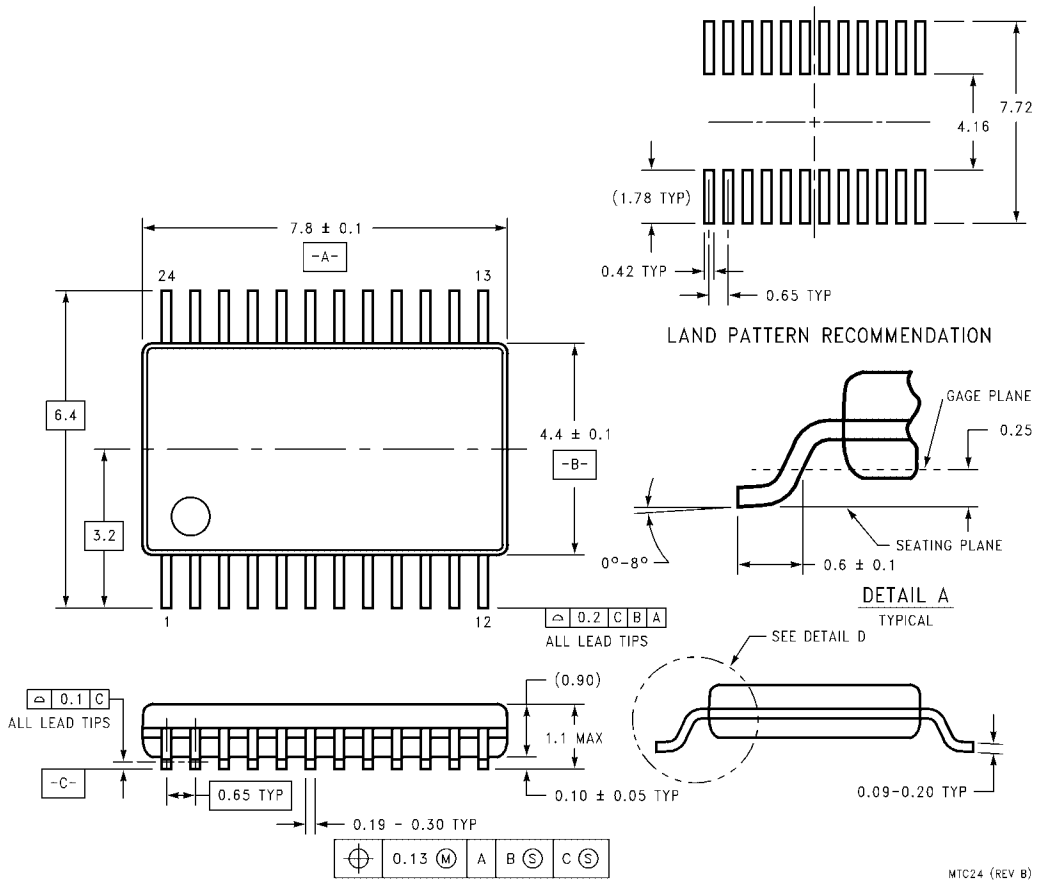

**24-Lead Thin Shrink Small Outline Package (TSSOP), JEDEC MO-153, 4.4mm Wide
Package Number MTC24**

MTC24 (REV B)

Physical Dimensions inches (millimeters) unless otherwise noted (Continued)

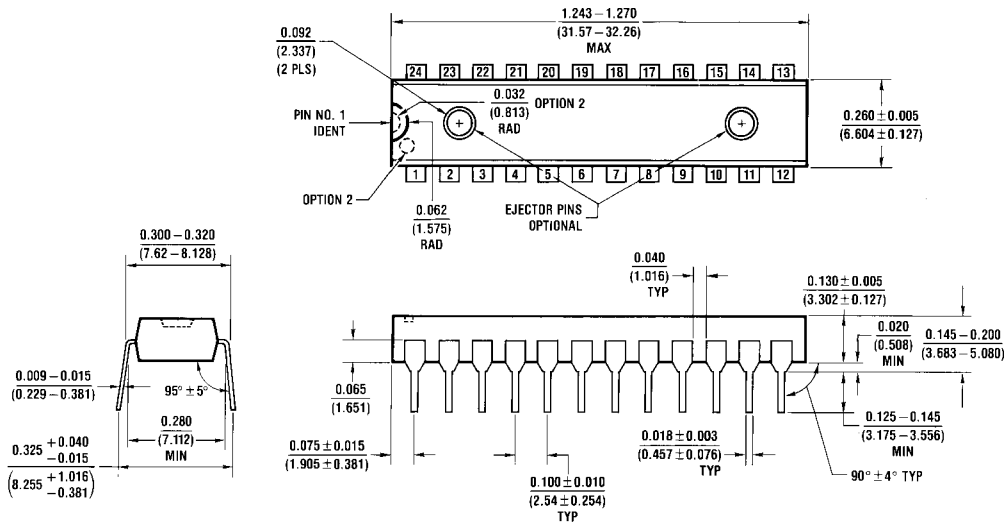

**24-Lead Plastic Dual-In-Line Package (PDIP), JEDEC MS-001, 0.300 Wide
Package Number N24C**

N24C (REV F)

Fairchild does not assume any responsibility for use of any circuitry described, no circuit patent licenses are implied and Fairchild reserves the right at any time without notice to change said circuitry and specifications.

LIFE SUPPORT POLICY

FAIRCHILD'S PRODUCTS ARE NOT AUTHORIZED FOR USE AS CRITICAL COMPONENTS IN LIFE SUPPORT DEVICES OR SYSTEMS WITHOUT THE EXPRESS WRITTEN APPROVAL OF THE PRESIDENT OF FAIRCHILD SEMICONDUCTOR CORPORATION. As used herein:

1. Life support devices or systems are devices or systems which, (a) are intended for surgical implant into the body, or (b) support or sustain life, and (c) whose failure to perform when properly used in accordance with instructions for use provided in the labeling, can be reasonably expected to result in a significant injury to the user.
2. A critical component in any component of a life support device or system whose failure to perform can be reasonably expected to cause the failure of the life support device or system, or to affect its safety or effectiveness.

www.fairchildsemi.com