



AC-DC UL/cUL ADAPTOR DC 24V 250mA

REV. Status

REVISION -  
10/25/01 RJ

REVISION A  
CHANGED  
INPUT TO 11W  
02/28/02 RJ

REVISION B  
REVISED PLUG  
LOCATION. ADDED  
RoHS  
05/23/06 MP

A. Electrical specifications

1. Input voltage: AC 120V ±10% 60Hz ±0.5Hz
2. Output voltage and current: DC 24V at 250mA

V <sub>in</sub>	100% Load	No Load
108	20.0VDC MIN	-
120	23.5-24.5VDC	32.0VDC MAX
132	-	35.0VDC MAX

NOTE: Specification applies after 10 minutes warm-up with full load and at any operating temperature.

3. Operating temperature: -10°C to +40°C
4. Storage temperature: -20°C to +85°C
5. Operating and Storage Humidity: 0 to 95% without condensation
6. Withstand voltage: AC 1000Vrms 1 minute @ input to output

B. Typical performance data test Condition:  
T<sub>a</sub> = +25°C measured after 10 minute warm-up with input at 120V 60Hz

C. Safety agencies  
UL and cUL File No. E218172

D. Nameplate: Information is as follows:  
Metallic letters on a black background

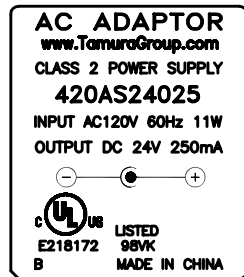

TYPICAL PERFORMANCE CHART

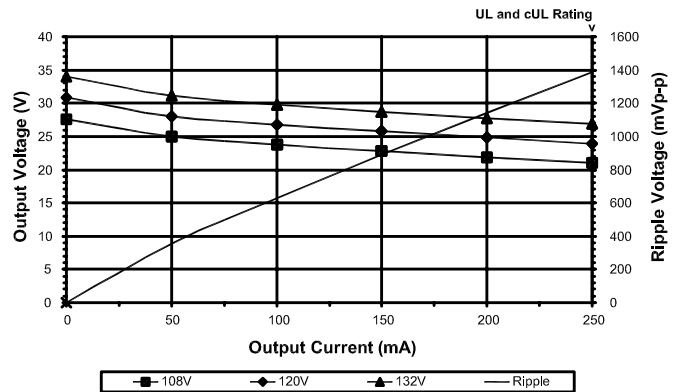

E. Mechanical Specifications

All dimensions shown are nominal unless otherwise specified

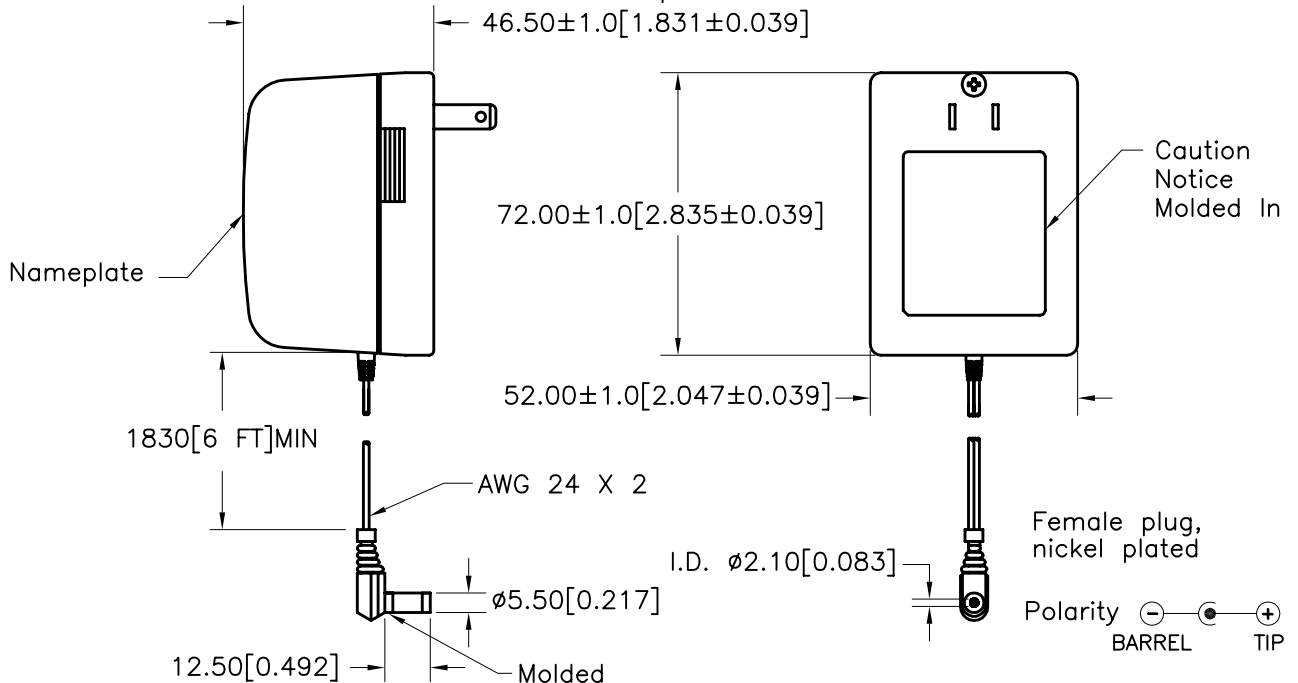

PREPARED BY:

K. BRENNAN

ENGINEER:

M. PITCHAI

QUALITY CONTROL:

T. CLEM

APPROVED:

Y. SEKIGUCHI

DWG CONTROL NO. P-A7-12948  
ACAD\PS\A7129481.DWG

REV B

UL/cUL DC 24V 250mA  
POWER SUPPLY

**TAMURA CORPORATION OF AMERICA**  
43352 BUSINESS PARK DRIVE, TEMECULA, CA. 92590-6624  
(951) 699-1270 FAX 9516769482

**420AS24025**

MODEL SPECIFICATION

DIM: mm(In) SCL: NONE SH: 1 OF 1

PROPRIETARY NOTICE: THIS DRAWING PRINT OR DOCUMENT AND SUBJECT MATTER DISCLOSED HEREIN ARE PROPRIETARY ITEMS TO WHICH TAMURA RETAINS THE EXCLUSIVE RIGHT OF DISSEMINATION, REPRODUCTION, MANUFACTURE AND SALE. THIS DRAWING, PRINT OR DOCUMENT IS SUBMITTED IN CONFIDENCE FOR CONSIDERATION BY THE RECIPIENT ALONE UNLESS PERMISSION FOR FURTHER DISCLOSURE IS EXPRESSLY GRANTED IN WRITING.

