

# 2N5460, 2N5461, 2N5462

## JFET Amplifier P-Channel – Depletion

### Features

- Pb-Free Packages are Available\*

### MAXIMUM RATINGS

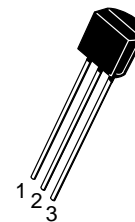
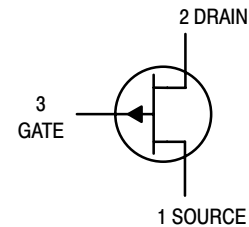
Rating	Symbol	Value	Unit
Drain – Gate Voltage	$V_{DG}$	40	Vdc
Reverse Gate – Source Voltage	$V_{GSR}$	40	Vdc
Forward Gate Current	$I_{G(f)}$	10	mAdc
Total Device Dissipation @ $T_A = 25^\circ\text{C}$ Derate above $25^\circ\text{C}$	$P_D$	350 2.8	mW mW/°C
Junction Temperature Range	$T_J$	-65 to +135	°C
Storage Channel Temperature Range	$T_{stg}$	-65 to +150	°C

Stresses exceeding Maximum Ratings may damage the device. Maximum Ratings are stress ratings only. Functional operation above the Recommended Operating Conditions is not implied. Extended exposure to stresses above the Recommended Operating Conditions may affect device reliability.



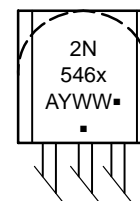
**ON Semiconductor®**

<http://onsemi.com>



**TO-92  
CASE 29  
STYLE 7**

### MARKING DIAGRAM



2N546x = Device Code

x = 0, 1, or 2

A = Assembly Location

Y = Year

WW = Work Week

■ = Pb-Free Package

(Note: Microdot may be in either location)

### ORDERING INFORMATION

See detailed ordering and shipping information in the package dimensions section on page 2 of this data sheet.

**Preferred** devices are recommended choices for future use and best overall value.

\*For additional information on our Pb-Free strategy and soldering details, please download the ON Semiconductor Soldering and Mounting Techniques Reference Manual, SOLDERRM/D.

## 2N5460, 2N5461, 2N5462

### ELECTRICAL CHARACTERISTICS ( $T_A = 25^\circ\text{C}$ unless otherwise noted)

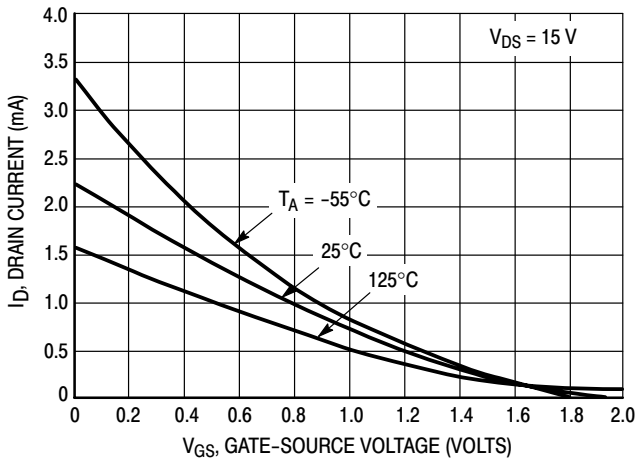
Characteristic		Symbol	Min	Typ	Max	Unit
<b>OFF CHARACTERISTICS</b>						
Gate–Source Breakdown Voltage ( $I_G = 10 \mu\text{Adc}$ , $V_{DS} = 0$ )	2N5460, 2N5461, 2N5462	$V_{(BR)GSS}$	40	–	–	Vdc
Gate Reverse Current ( $V_{GS} = 20 \text{ Vdc}$ , $V_{DS} = 0$ )	2N5460, 2N5461, 2N5462	$I_{GSS}$	–	–	5.0	nAdc
( $V_{GS} = 30 \text{ Vdc}$ , $V_{DS} = 0$ )						
( $V_{GS} = 20 \text{ Vdc}$ , $V_{DS} = 0$ , $T_A = 100^\circ\text{C}$ )	2N5460, 2N5461, 2N5462		–	–	1.0	$\mu\text{Adc}$
( $V_{GS} = 30 \text{ Vdc}$ , $V_{DS} = 0$ , $T_A = 100^\circ\text{C}$ )						
Gate–Source Cutoff Voltage ( $V_{DS} = 15 \text{ Vdc}$ , $I_D = 1.0 \mu\text{Adc}$ )	2N5460 2N5461 2N5462	$V_{GS(off)}$	0.75 1.0 1.8	– – –	6.0 7.5 9.0	Vdc
Gate–Source Voltage ( $V_{DS} = 15 \text{ Vdc}$ , $I_D = 0.1 \text{ mAdc}$ )	2N5460	$V_{GS}$	0.5	–	4.0	Vdc
( $V_{DS} = 15 \text{ Vdc}$ , $I_D = 0.2 \text{ mAdc}$ )	2N5461		0.8	–	4.5	
( $V_{DS} = 15 \text{ Vdc}$ , $I_D = 0.4 \text{ mAdc}$ )	2N5462		1.5	–	6.0	
<b>ON CHARACTERISTICS</b>						
Zero–Gate–Voltage Drain Current ( $V_{DS} = 15 \text{ Vdc}$ , $V_{GS} = 0$ , $f = 1.0 \text{ kHz}$ )	2N5460 2N5461 2N5462	$I_{DSS}$	–1.0 –2.0 –4.0	– – –	–5.0 –9.0 –16	mAdc
<b>SMALL–SIGNAL CHARACTERISTICS</b>						
Forward Transfer Admittance ( $V_{DS} = 15 \text{ Vdc}$ , $V_{GS} = 0$ , $f = 1.0 \text{ kHz}$ )	2N5460 2N5461 2N5462	$ y_{fs} $	1000 1500 2000	– – –	4000 5000 6000	$\mu\text{hos}$
Output Admittance ( $V_{DS} = 15 \text{ Vdc}$ , $V_{GS} = 0$ , $f = 1.0 \text{ kHz}$ )		$ y_{os} $	–	–	75	$\mu\text{hos}$
Input Capacitance ( $V_{DS} = 15 \text{ Vdc}$ , $V_{GS} = 0$ , $f = 1.0 \text{ MHz}$ )		$C_{iss}$	–	5.0	7.0	pF
Reverse Transfer Capacitance ( $V_{DS} = 15 \text{ Vdc}$ , $V_{GS} = 0$ , $f = 1.0 \text{ MHz}$ )		$C_{rss}$	–	1.0	2.0	pF
<b>FUNCTIONAL CHARACTERISTICS</b>						
Equivalent Short–Circuit Input Noise Voltage ( $V_{DS} = 15 \text{ Vdc}$ , $V_{GS} = 0$ , $f = 100 \text{ Hz}$ , $\text{BW} = 1.0 \text{ Hz}$ )		$e_n$	–	60	115	$\text{nV}/\sqrt{\text{Hz}}$

### ORDERING INFORMATION

Device	Package	Shipping†
2N5460	TO–92	1000 Units / Box
2N5460G	TO–92 (Pb–Free)	
2N5461	TO–92	
2N5461G	TO–92 (Pb–Free)	
2N5461RLRA	TO–92	2000 / Tape & Reel
2N5461RLRAG	TO–92 (Pb–Free)	
2N5462	TO–92	1000 Units / Box
2N5462G	TO–92 (Pb–Free)	

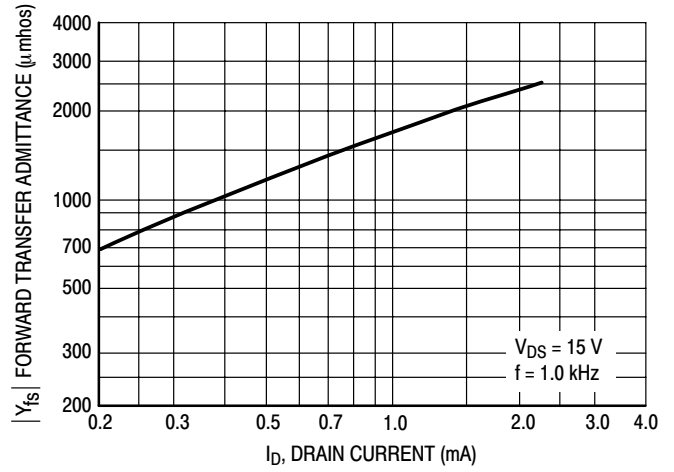
†For information on tape and reel specifications, including part orientation and tape sizes, please refer to our Tape and Reel Packaging Specifications Brochure, BRD8011/D.

**DRAIN CURRENT versus GATE SOURCE VOLTAGE**

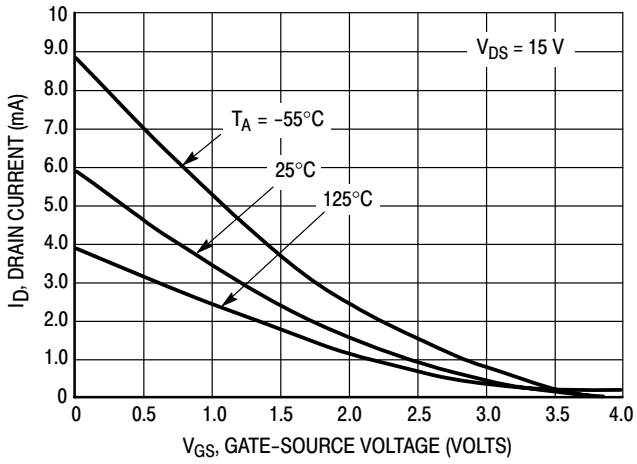


**Figure 1.  $V_{GS(off)} = 2.0\text{ V}$**

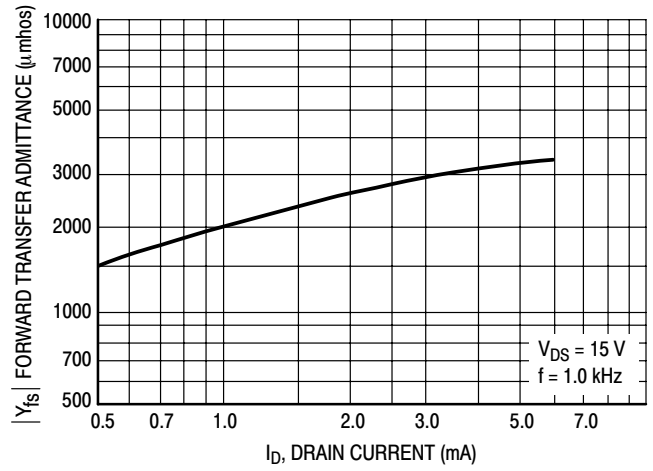
**FORWARD TRANSFER ADMITTANCE versus DRAIN CURRENT**



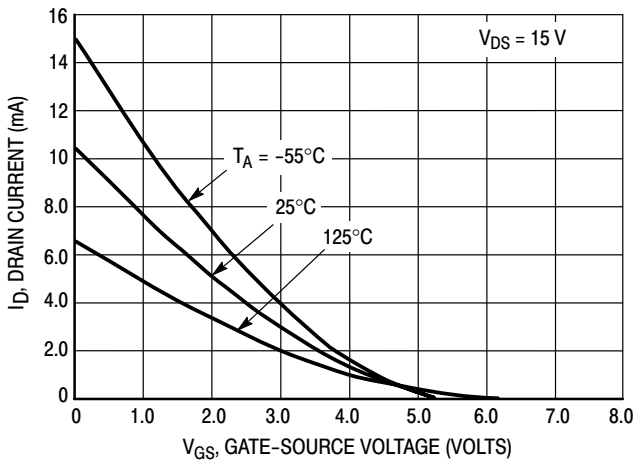
**Figure 4.  $V_{GS(off)} = 2.0\text{ V}$**



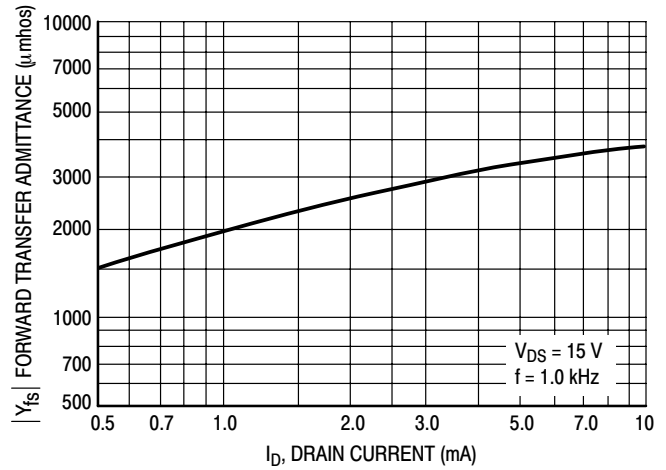
**Figure 2.  $V_{GS(off)} = 4.0\text{ V}$**



**Figure 5.  $V_{GS(off)} = 4.0\text{ V}$**

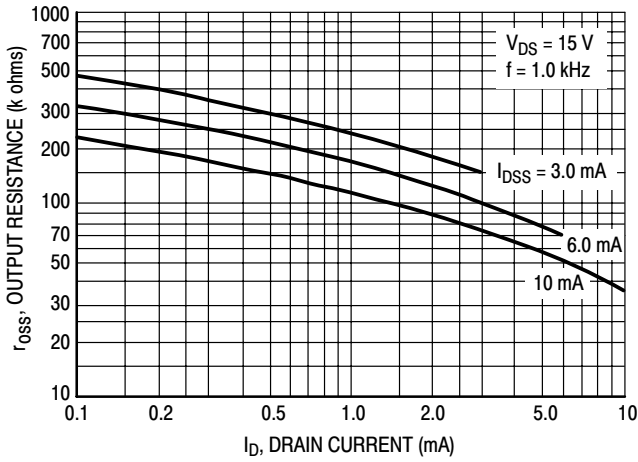


**Figure 3.  $V_{GS(off)} = 5.0\text{ V}$**

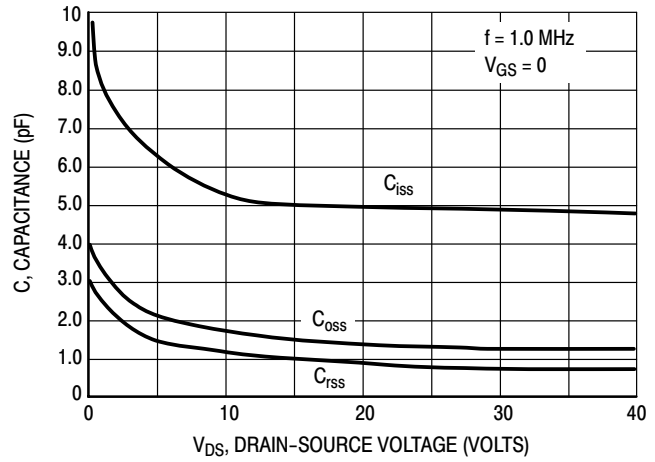


**Figure 6.  $V_{GS(off)} = 5.0\text{ V}$**

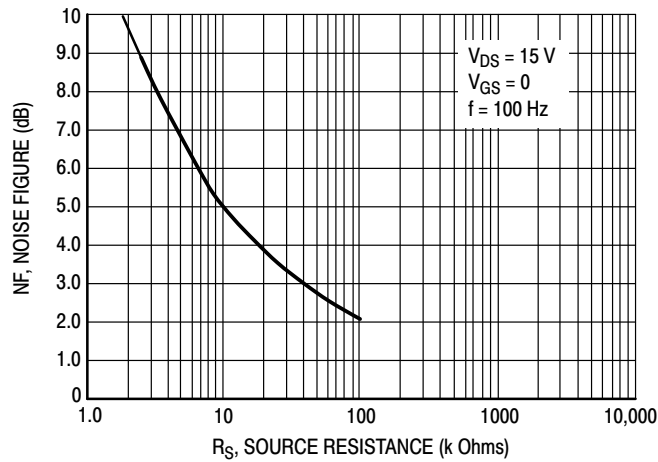
## 2N5460, 2N5461, 2N5462



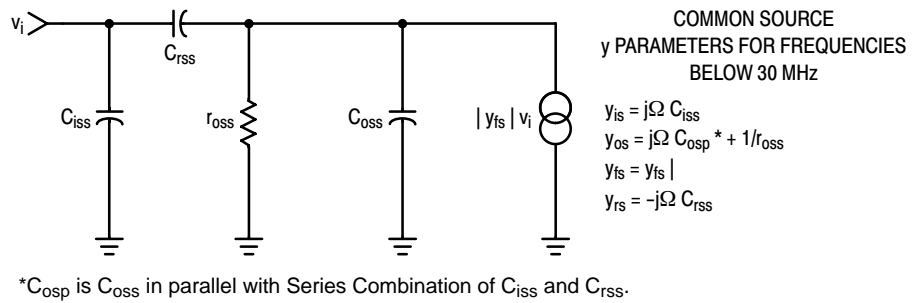
**Figure 7. Output Resistance versus Drain Current**



**Figure 8. Capacitance versus Drain-Source Voltage**



**Figure 9. Noise Figure versus Source Resistance**



**NOTE:**

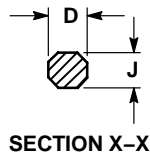
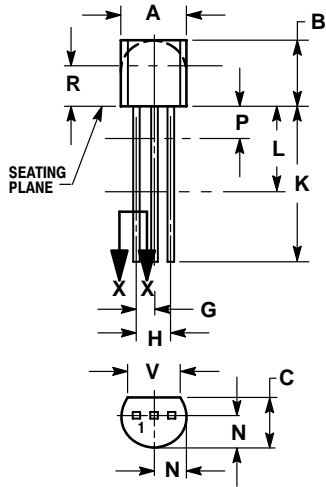
- Graphical data is presented for dc conditions. Tabular data is given for pulsed conditions (Pulse Width = 630 ms, Duty Cycle = 10%).

**Figure 10. Equivalent Low Frequency Circuit**

# 2N5460, 2N5461, 2N5462

## PACKAGE DIMENSIONS

TO-92  
CASE 29-11  
ISSUE AL



NOTES:

1. DIMENSIONING AND TOLERANCING PER ANSI Y14.5M, 1982.
2. CONTROLLING DIMENSION: INCH.
3. CONTOUR OF PACKAGE BEYOND DIMENSION R IS UNCONTROLLED.
4. LEAD DIMENSION IS UNCONTROLLED IN P AND BEYOND DIMENSION K MINIMUM.

DIM	INCHES		MILLIMETERS	
	MIN	MAX	MIN	MAX
A	0.175	0.205	4.45	5.20
B	0.170	0.210	4.32	5.33
C	0.125	0.165	3.18	4.19
D	0.016	0.021	0.407	0.533
G	0.045	0.055	1.15	1.39
H	0.095	0.105	2.42	2.66
J	0.015	0.020	0.39	0.50
K	0.500	---	12.70	---
L	0.250	---	6.35	---
N	0.080	0.105	2.04	2.66
P	---	0.100	---	2.54
R	0.115	---	2.93	---
V	0.135	---	3.43	---

STYLE 7:

1. SOURCE
2. DRAIN
3. GATE

ON Semiconductor and are registered trademarks of Semiconductor Components Industries, LLC (SCILLC). SCILLC reserves the right to make changes without further notice to any products herein. SCILLC makes no warranty, representation or guarantee regarding the suitability of its products for any particular purpose, nor does SCILLC assume any liability arising out of the application or use of any product or circuit, and specifically disclaims any and all liability, including without limitation special, consequential or incidental damages. "Typical" parameters which may be provided in SCILLC data sheets and/or specifications can and do vary in different applications and actual performance may vary over time. All operating parameters, including "Typicals" must be validated for each customer application by customer's technical experts. SCILLC does not convey any license under its patent rights nor the rights of others. SCILLC products are not designed, intended, or authorized for use as components in systems intended for surgical implant into the body, or other applications intended to support or sustain life, or for any other application in which the failure of the SCILLC product could create a situation where personal injury or death may occur. Should Buyer purchase or use SCILLC products for any such unintended or unauthorized application, Buyer shall indemnify and hold SCILLC and its officers, employees, subsidiaries, affiliates, and distributors harmless against all claims, costs, damages, and expenses, and reasonable attorney fees arising out of, directly or indirectly, any claim of personal injury or death associated with such unintended or unauthorized use, even if such claim alleges that SCILLC was negligent regarding the design or manufacture of the part. SCILLC is an Equal Opportunity/Affirmative Action Employer. This literature is subject to all applicable copyright laws and is not for resale in any manner.

### PUBLICATION ORDERING INFORMATION

**LITERATURE FULFILLMENT:**  
Literature Distribution Center for ON Semiconductor  
P.O. Box 61312, Phoenix, Arizona 85082-1312 USA  
**Phone:** 480-829-7710 or 800-344-3860 Toll Free USA/Canada  
**Fax:** 480-829-7709 or 800-344-3867 Toll Free USA/Canada  
**Email:** orderlit@onsemi.com

**N. American Technical Support:** 800-282-9855 Toll Free USA/Canada

**Japan:** ON Semiconductor, Japan Customer Focus Center  
2-9-1 Kamimeguro, Meguro-ku, Tokyo, Japan 153-0051  
**Phone:** 81-3-5773-3850

**ON Semiconductor Website:** <http://onsemi.com>

**Order Literature:** <http://www.onsemi.com/litorder>

For additional information, please contact your local Sales Representative.