









20 19 18 17 16 15 14 13 12 11 10 9 8 7 6 5 4 3 2 1

MATERIAL NUMBER PCB THICKNESS >4.0 - 9.0	MATERIAL NUMBER PCB THICKNESS 18 - 4.0	BUSHING CLOCK POSITION
74952-5901	74952-5001	A 
74952-5902	74952-5002	B 
74952-5903	74952-5003	C 
74952-5904	74952-5004	D 
74952-5905	74952-5005	E 
74952-5906	74952-5006	F 
74952-5907	74952-5007	G 
74952-5908	74952-5008	H 

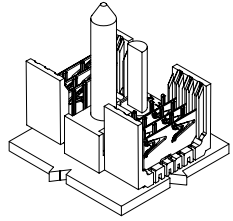
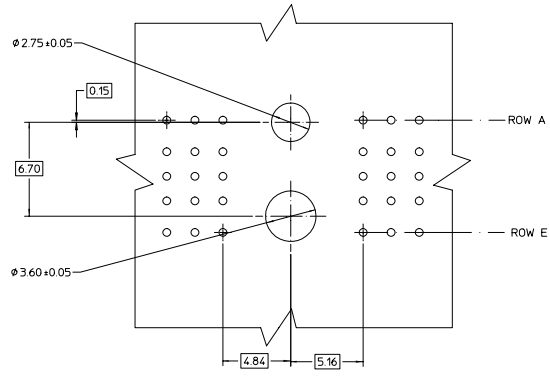
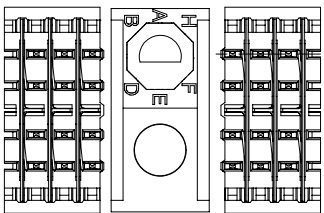

BILL OF MATERIAL FOR 74952-50**

ITEM	DESCRIPTION	QTY.
1	GUIDE PIN	1
2	GUIDANCE & POLARIZING MODULE	1
3	KEYING PIN	1
4	SCREW & WASHER (PCB 18-4.0)	1

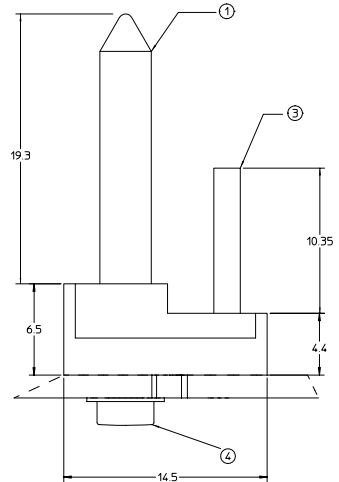
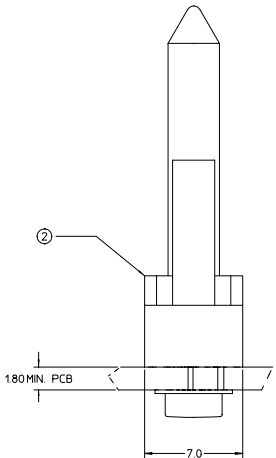

BILL OF MATERIAL FOR 74952-59**

ITEM	DESCRIPTION	QTY.
1	GUIDE PIN	1
2	GUIDANCE & POLARIZING MODULE	1
3	KEYING PIN	1
4	SCREW & WASHER (PCB >4.0-9.0)	1

- NOTES:**
- MATERIAL:
HOUSING: LIQUID CRYSTAL POLYMER (LCP),
COLOR: BLACK
GUIDE PIN / KEYING PIN: STAINLESS STEEL
 - THIS PART CONFORMS TO MOLEX PRODUCT SPECIFICATION PS-74031-999.
 - PACKAGING: STANDARD BULK PACK, 100 PER BAG PACKAGE SCREW SEPARATELY.

EC NO. UDT2002-0216 DRWN: LMSLEY 2001/12/19 CHKD: SREED 2001/12/19 APPR: CBXLER 2001/12/20	QUALITY SYMBOLS ▽-0 ▽-0	GENERAL TOLERANCES (UNLESS SPECIFIED)		SCALE 6:1	DESIGN UNITS METRIC	THIRD ANGLE PROJECTION REVISE ON CAD ONLY	TITLE BACKPLANE GUIDANCE AND POLARIZING MODULE 5 ROW HSD SALES DRAWING MOLEX MOLEX INCORPORATED	
		4 PLACES ± --- ± --- 3 PLACES ± --- ± --- 2 PLACES ± --- ± --- 1 PLACE ± --- ± ---		DIMENSION STYLE MM ONLY				
		ANGULAR ± 2 °		DRAWN BY NMARTIN	DATE 01/12/11	CHECKED BY SREED		DATE 01/12/11
		DRAFT WHERE APPLICABLE MUST REMAIN WITHIN DIMENSIONS		APPROVED BY CBXLER	DATE 01/12/11	MATERIAL NO. SEE CHART		DOCUMENT NO. SD-74952-002